

Lynx Smart BMS NG Manual

500A (M10) | 1000A (M10)

Table of Contents

1. Introduction	1
1.1. The Lynx Smart BMS NG	1
1.2. Features	1
1.3. Communication and interfacing	2
2. System Design considerations and examples	3
2.1. Integration into the Lynx Distributor System	3
2.2. System sizing	4
2.2.1. Current rating Lynx Smart BMS NG	4
2.2.2. Fusing	4
2.2.3. Cabling	4
3. Installation	5
3.1. Important warning	5
3.2. Safety Precautions	5
3.2.1. Safety Warnings Lynx Distribution System	5
3.3. Mechanical connections	6
3.3.1. Lynx Smart BMS NG connection features	6
3.3.2. Mounting and interconnecting Lynx modules	6
3.4. Electrical connections	7
3.4.1. Connect DC wires	7
3.4.2. Connect RJ10 cable(s)	7
3.4.3. Connect BMS cables	8
3.4.4. Connect the Multi-connector	8
3.4.5. Connect ATC/ATD controlled loads and chargers	9
3.4.6. Wiring the Remote on/off	9
3.4.7. Programmable relay wiring	10
3.4.8. Connect the GX device	10
3.5. System examples in detail	11
3.5.1. Lynx Smart BMS NG , 2x Lynx Distributor and Lithium NG batteries	11
3.5.2. Lynx Smart BMS NG, 1x Lynx Distributor and Lithium NG batteries	12
3.5.3. Lynx Smart BMS NG only	12
4. Configuration and settings	13
4.1. Power up for the first time	13
4.2. Update firmware	13
4.3. Lynx Smart BMS NG settings	14
4.4. Lynx Distributor settings	16
4.5. Bluetooth reactivation	16
5. Commissioning, operation and monitoring	17
5.1. Commissioning the Lynx Smart BMS NG	17
5.2. Powering up	18
5.3. BMS operating modes	19
5.4. Lynx Smart BMS NG trigger	20
5.5. Battery monitor operation	20
5.6. Monitoring & Control	21
5.6.1. Monitoring the BMS via VictronConnect and VC-R	22
5.6.2. VictronConnect Instant Readout	23
5.6.3. Monitoring the BMS via GX device	24
5.6.4. Monitoring the BMS via VRM Portal	30
5.7. Battery care	31
6. Paralleling Lynx BMSes	32
6.1. Introduction	32
6.2. Requirements and limitations	32
6.3. Electrical connections	33
6.4. Monitoring and control	35
6.5. Frequently Asked Questions (FAQ)	35
7. Troubleshooting and Support	38

7.1. How to recover from OFF mode when no charge voltage was detected	38
7.2. Lynx Smart BMS NG does not power up	38
7.3. Lynx Smart BMS NG operational issues	39
7.4. BMS issues	40
7.4.1. The BMS frequently disables the battery charger	40
7.4.2. The BMS displays an alarm even though all cell voltages are within range	40
7.4.3. How to test if the BMS is functional	40
7.4.4. System in OFF mode	41
7.4.5. ATC/ATD is missing	41
7.5. Battery monitor issues	41
7.5.1. Incomplete current reading	41
7.5.2. Incorrect state of charge reading	41
7.5.3. Synchronisation issues	42
7.6. VictronConnect issues	42
7.7. GX device issues	42
8. Technical specifications	43
9. Appendix	45
9.1. LED indications, warning, alarm and error codes	45
9.2. Supported NMEA 2000 PGNs	48
9.3. List of battery monitor settings	49
9.4. Multi-connector pin-out and overview	49
9.5. Lynx Smart BMS NG-related menu structure of the GX device	49
9.6. Reversed power distribution	51
9.6.1. Introduction	51
9.6.2. Models and variants	51
9.6.3. Technical background	52
9.6.4. Wiring adjustment procedure	52
9.6.5. Configuring the reversed current setting	53
9.6.6. Final check	53
9.7. Enclosure dimensions	54

1. Introduction

1.1. The Lynx Smart BMS NG

The Lynx Smart BMS NG is a dedicated Battery Management System for [Victron Lithium NG](#) (not to be confused with the Lynx Smart BMS 500A, which is for Victron Smart Lithium batteries) batteries available with a nominal voltage of 12.8V, 25.6V and 51.2V in various capacities. This is the safest of the mainstream lithium battery types. The maximum number of batteries in one system is 50, which results in a maximum energy storage of 192kWh in a 12V system and up to 384kWh in a 24V and 48V system. The maximum energy storage capacity can be multiplied by paralleling multiple Lynx Smart BMSs, which also ensures redundancy should one battery bank fail.

Multiple BMS-es are available for our Lithium NG series of batteries, and the Lynx Smart BMS NG is the most feature-rich and complete option. Its main features are:

- Built-in 500A or 1000A contactor used as a fallback safety mechanism and also suitable as a remote controllable main system switch.
- Battery monitor, indicating state of charge percentage and more data.
- Pre-alarm signal: provides a warning before the system shuts down due to a low cell voltage.
- Bluetooth for use with our [VictronConnect App](#), for setup, monitoring and diagnostic.
- Local and remote monitoring using a Victron GX device, for example, the [Cerbo GX](#) and our [VRM portal](#).
- M10 busbar - The Lynx Smart BMS NG integrates seamlessly into our [Lynx Distributor system](#) and can be connected to all Lynx M10 products.

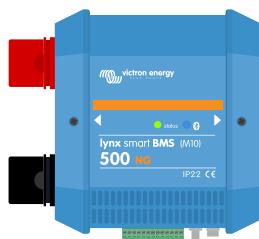

Lynx Smart BMS NG 500A

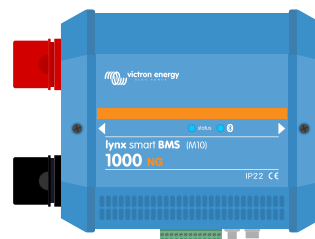

Lynx Smart BMS NG 1000A

1.2. Features

Battery Management System

The BMS monitors, controls, and protects your Victron Lithium NG batteries. It detects the state of charge and protects against deep discharge and overcharging.

Its main features are:

- **Pre-alarm mode** configurable via the programmable relay
- **ATC/ATD ports** to control chargers and loads
- **DVCC closed loop control** for compatible Victron inverter/charger, Orion XS DC-DC battery charger and MPPTs via a connected GX device
- **Discharge floor** used to set the minimum SoC to determine how far the battery is allowed to be discharged

A pre-alarm warns with a minimum delay of 30 seconds of an imminent shutdown of the loads as a result of an impending low cell voltage. By reacting quickly on the pre-alarm, for example, by reducing the load or starting a generator to charge the batteries, the shutting down of the loads can be prevented.

The ATC contact is opened to stop charging at a high cell voltage or low temperature, while the ATD contact is opened to stop discharging at a low cell voltage.

DVCC controls compatible devices via Lynx Smart BMS NG and a connected GX device with the advantage of no additional wiring or configuration for those devices. Charging current and voltages are set automatically, thus Bulk, Absorption and Float

algorithms are no longer used. Charging or discharging are stopped at low or high cell voltage or low temperature. For more information about DVCC, please check the [GX device manual](#).

Contactor

The built-in contactor serves two purposes:

1. It acts as a secondary safety system to protect the battery in case the primary controls (ATC and ATD contacts as well as DVCC) fail to disable the loads and/or chargers when required.
2. It can be used as a remote controlled main system on/off switch via the VictronConnect app, a GX device (only Standby and On), as well as using the Remote on/off terminals.

Built-in pre-charge circuit

The built-in pre-charge circuit pre-charges capacitive loads such as inverters or inverter/chargers before the contactor closes to prevent high inrush current.

Battery Monitor

The Lynx Smart BMS NG battery monitor operates in a similar fashion as the other [Victron Energy battery monitors](#). It contains a shunt and battery monitor electronics. Readout of the battery monitor data is via Bluetooth using the VictronConnect App or a GX device and the VRM portal.

Programmable relay

The Lynx Smart BMS NG has a programmable relay that can be used as an alarm relay (combined with the pre-alarm) or to shut down an alternator via its external regulator (ignition wire).

AUX terminal

The Lynx Smart BMS NG is equipped with an auxiliary power supply. This supply outputs the same voltage as the system battery voltage and is rated at a maximum continuous current rating of 1.1A.

The purpose of the auxiliary power supply is to keep certain systems powered, for example a GX device, after the BMS has turned off loads in case of a low cell voltage event.



It is recommended that the system includes a GX device powered by the AUX port. This keeps the GX device supplied with power until the AUX port is finally switched off (max. 5 minutes after a low cell voltage event) to preserve energy for battery self-discharge.

Parallel redundant Lynx Smart BMS

The new parallel redundancy feature for the Lynx Smart BMS and Lynx Smart BMS NG series allows multiple Lynx BMSes in one installation. Each has its own battery bank, and together they form a single redundant battery system. Up to 5 BMS-es can be paralleled. For more details, please see the [Paralleling Lynx BMSes \[32\]](#) chapter.

1.3. Communication and interfacing

The Lynx Smart BMS NG communicates via various interfaces with other devices and services. The following list provides an overview of the most important interfaces:

- **Bluetooth:** to change settings and monitor the Lynx Smart BMS NG via [our VictronConnect App](#).
Note that Bluetooth can be disabled via VictronConnect or a GX device but can only be re-enabled from a GX device.
- **VE.Can:** to connect a GX device to the Lynx Smart BMS NG. The GX device will show all measured parameters, operational state, battery SoC, cell voltages and temperatures, and alarms, and make them available to be controlled via our remote monitoring [VRM portal](#).
- **Lynx Distributor fuse monitoring:** via our VictronConnect app and a connected GX device. Communication with the Lynx Distributors is via its RJ10 connectors. The Lynx Smart BMS NG can be used to read out the Lynx Distributors, generate alarms in case a fuse is blown or communication is lost. Fuse status communication requires Lynx Distributor with serial number HQ1909 or later.
- **NMEA 2000 via VE.Can:** Communication to an NMEA 2000 network can be established via VE.Can using a [VE.Can to NMEA2000 micro-C cable](#). See the [Supported NMEA 2000 PGNs \[48\]](#) in the appendix for more information.

2. System Design considerations and examples

2.1. Integration into the Lynx Distributor System

The Lynx Smart BMS NG integrates seamlessly with the [Lynx Distributor](#) system, which is not mandatory for operation, but highly recommended due to its ease of installation.

It is important to note that the battery must always be connected to the left side of the Lynx Smart BMS NG (in normal position), while all loads and chargers are connected to the right side.

The example below shows the Lynx Smart BMS NG in a system with two Lynx Distributors. Together they form a continuous busbar with fused battery connections, battery monitor, BMS system, contactor and fused load connections.

The Lynx modules can be mounted in any orientation. If they are mounted upside down, the text on the front of the units will be upside down as well. To ensure that the text is orientated correctly, use the special stickers included with each Lynx module.

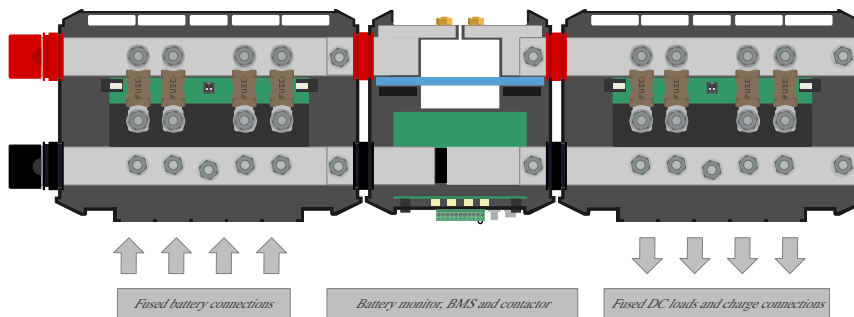

Lynx Smart BMS NG with two Lynx Distributors

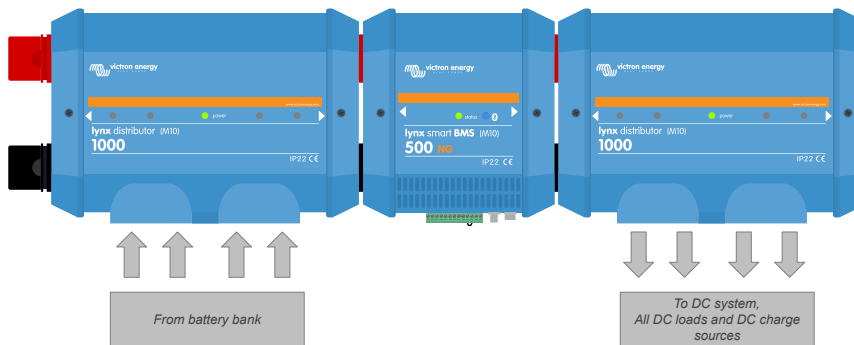

Example of Lynx module orientation: the batteries connect to the left, and all loads and chargers connect on the right side

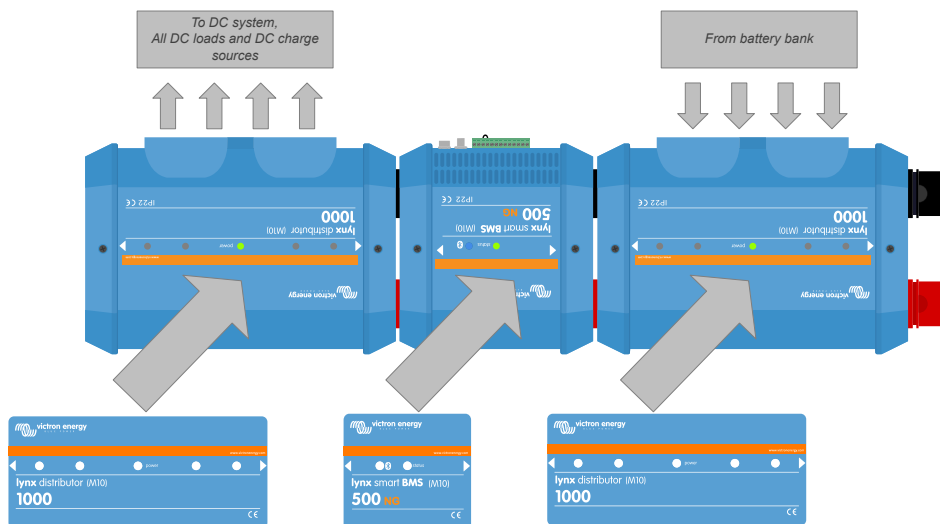

Example of Lynx modules mounted upside down: now the batteries connect to the right side, all loads and chargers connect to the left side and the upside-down stickers (included) are affixed.



It is important to note that the battery is always connected to the left side of the Lynx Smart BMS NG (in normal position), while all loads and chargers go to the right side.

2.2. System sizing

2.2.1. Current rating Lynx Smart BMS NG

The main safety contactor of the Lynx Smart BMS NG has a continuous current rating of 500A or 1000A, depending on the model, and a peak current rating of 600A or 1200A for a duration of 5 minutes. Even if the Lynx Smart BMS NG has an overcurrent protection, ensure the current rating is not exceeded.

The following happens if the peak current limit or the 5-minute interval has been exceeded:

- An overcurrent alarm will be generated
- ATC or ATD (depending on current direction) is disabled after a 30s delay

The table below shows how much power a Lynx Smart BMS NG is rated for at different voltages. This will indicate how big the connected inverter/charger system can be. Remember that if inverters or inverter/chargers are used, the AC and DC systems will be powered by the batteries.

Voltage vs. Current	12V	24V	48V
500A	6kW	12kW	24kW
1000A	12kW	24kW	48kW

2.2.2. Fusing

The Lynx Smart BMS NG is not a system fuse. It only warns when the current is too high. Fusing needs to be done externally, for example by connecting Lynx Distributor modules to the Lynx Smart BMS NG or by using [external fuse holders and fuses](#).

Always use fuses with the correct voltage and current rating. Match the fuse rating to the maximum voltages and currents that can potentially occur in the fused circuit. For more information on fuse ratings and fuse current calculations see the [Wiring Unlimited book](#).



The total value of the fuses of all circuits should not be more than the current rating of the Lynx module or the Lynx model with the lowest current rating if multiple Lynx modules are used.

2.2.3. Cabling

The current rating of the wires or cables used to connect the Lynx Smart BMS NG to batteries and/or the DC loads, has to be rated for the maximum currents that can occur in the connected circuits. Use cabling with a sufficient core surface area to match the maximum current rating of the circuit.

For more information on cabling and cable thickness calculations see our book, [Wiring Unlimited](#).

3. Installation

3.1. Important warning



Lithium batteries are expensive and can be damaged due to over-discharge or overcharge.

The shutdown due to low cell voltage by the BMS should always be used as a last resort to be safe at all times. We recommend not letting it get that far in the first place and instead either shutting down the system automatically after a defined state of charge (this can be done by using the discharge floor in the [Lynx Smart BMS NG settings \[14\]](#) in the BMS) so that there is always enough reserve capacity in the battery, or by wiring a remote on/off switch and use it as a system on/off switch; see [Wiring the Remote on/off \[9\]](#) for more details.

Damage due to over-discharge can occur if small loads (such as alarm systems, relays, standby currents of certain loads, the back current drain of battery chargers, or charge regulators) slowly discharge the battery when the system is not in use.

If you are unsure about a possible residual current draw, isolate the battery by opening the battery switch, pulling the battery fuse(s), or disconnecting the battery positive when the system is not in use.

A residual discharge current is especially dangerous if the system has been discharged completely and a low cell voltage shutdown has occurred. After shutdown due to low cell voltage, a capacity reserve of approximately 1Ah per 100Ah battery capacity is left in the battery. The battery will be damaged if the remaining capacity reserve is drawn from the battery; for example, a residual current of just 10mA can damage a 200Ah battery if the system is left discharged for more than 8 days.

Immediate action (recharge the battery) is required if a low cell voltage disconnect has occurred.



If Bluetooth is deactivated on the Lynx Smart BMS NG, it can only be reactivated via a GX device in the BMS settings menu. For installations without a GX device, this must be taken into account before disabling Bluetooth. Without Bluetooth, configuration via VictronConnect is not possible.

3.2. Safety Precautions

3.2.1. Safety Warnings Lynx Distribution System



- Installation must strictly follow the national safety regulations in compliance with the enclosure, installation, creepage, clearance, casualty, markings and segregation requirements of the end-use application.
- Installation must be performed by qualified and trained installers only.
- Do not work on live busbars. Before removing the Lynx front cover, disconnect all positive battery poles to ensure that the busbar is unpowered.
- Only qualified personnel should work on batteries. Observe the battery safety warnings listed in the battery manual.
- Store this product in a dry environment. The storage temperature should be -40°C to $+65^{\circ}\text{C}$.
- No liability can be accepted for damage in transit if the equipment is not transported in its original packaging.

3.3. Mechanical connections

3.3.1. Lynx Smart BMS NG connection features

- The Lynx Smart BMS NG cover can be opened up by unscrewing the two cover screws.
- Removable rubber sleeves to protect the busbar ends.

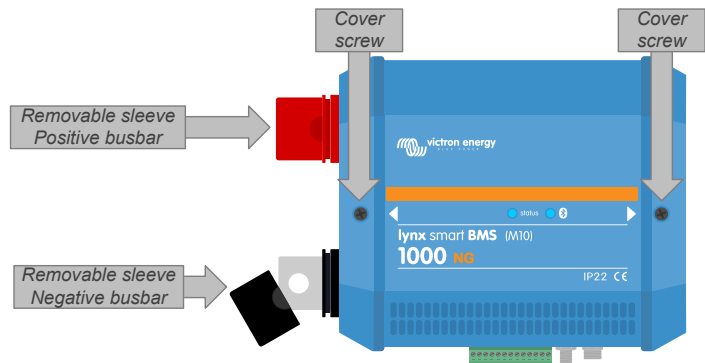

3.3.2. Mounting and interconnecting Lynx modules

This paragraph explains how to attach several Lynx modules to each other and how to mount the Lynx assembly into its final location. These are the points to take into consideration when interconnecting and mounting Lynx modules:

- If Lynx modules are going to be connected to the right and if the Lynx module is fitted with a plastic barrier on the right side, remove the black plastic barrier. If the Lynx module is located as the most right module, leave the black plastic barrier in place.
- If Lynx modules are going to be connected to the left, remove the red and black rubber sleeves. If the Lynx module is located as the most left module, leave the red and black rubber sleeves in place.
- Remember that for a Lynx Smart BMS NG, the left side is the battery side, and the right side is the DC system side.
- Connect all Lynx modules to each other using the M10 holes and bolts on the left and right. Ensure that the modules slot into the rubber joiner recesses correctly.
- Place the washer, spring washer and nut on the bolts in the correct order and tighten the bolts using a torque of:
- Mount the Lynx assembly in its final location using the 5mm mounting holes.

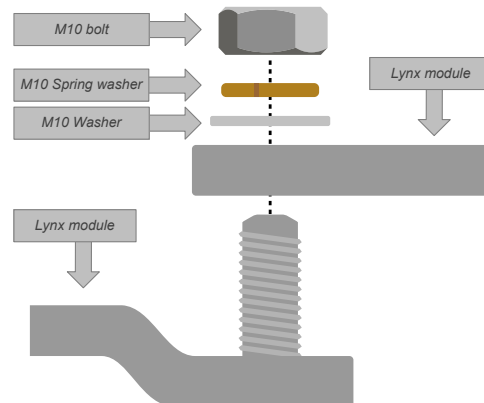

3.4. Electrical connections

3.4.1. Connect DC wires

For all DC connections, the following applies:

- All cables and wires connected directly to the Lynx Smart BMS NG must be fitted with M10 cable lugs.
- When attaching the cable to the bolt, pay attention to the correct placement and order of the cable lug, washer, spring washer, and nut on each bolt.
- Tighten the nuts using a torque of 33 Nm.

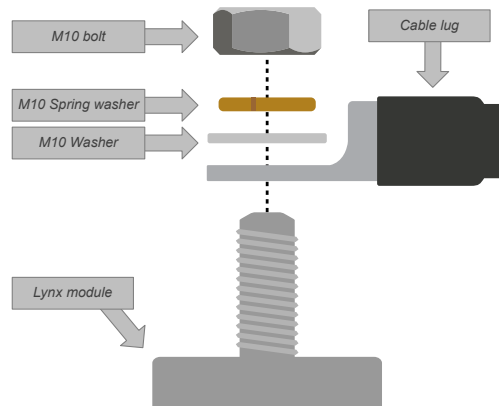

3.4.2. Connect RJ10 cable(s)

These instructions only apply if the system contains Lynx Distributor(s).

Each Lynx module has two RJ10 connectors, one on the left and one on the right. See the drawing below.

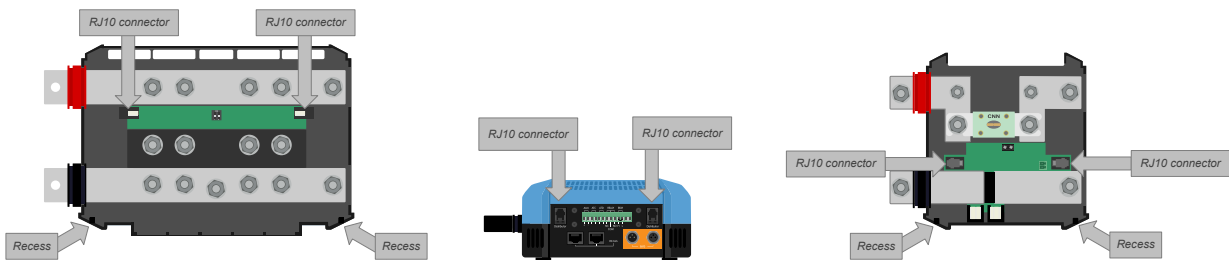

Locations of the RJ10 connectors and RJ10 cable recesses on the Lynx Distributor, Lynx Smart BMS NG and the Lynx Shunt VE.Can

To connect the RJ10 cables between the Lynx Smart BMS NG and Lynx Distributor, do the following:

- Plug one side of the RJ10 cable in the RJ10 connector of the Lynx Distributor, with the retainer clip of the RJ10 connector facing away from you.
- Feed the RJ10 cable through the recess at the bottom of the Lynx Distributor, see above picture.
- Plug the RJ10 cable into the RJ10 connector at the bottom of the Lynx Smart BMS NG.

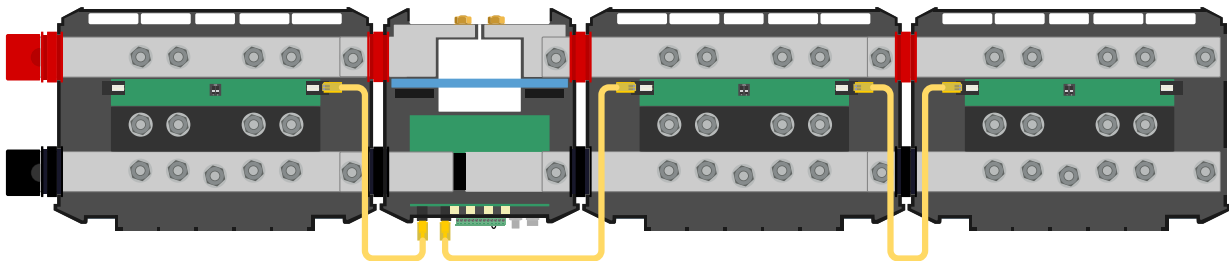

Connection example Lynx Smart BMS NG system - RJ10 cables indicated in yellow

3.4.3. Connect BMS cables

Connect the BMS cables from the lithium battery to the BMS connectors on the Lynx Smart BMS NG.

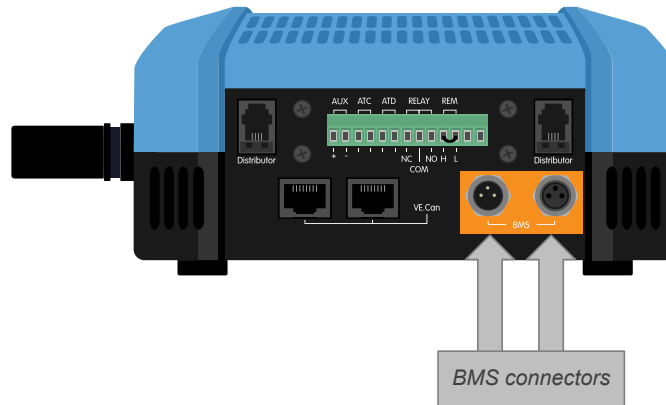

Location of the BMS cable connectors

If multiple batteries (up to 50 batteries can be connected to the BMS) are used, first interconnect the battery BMS cables and then connect the BMS cable from the first and last battery to the BMS connectors on the Lynx Smart BMS NG.

If the BMS cables are too short, use [BMS extension cables](#).

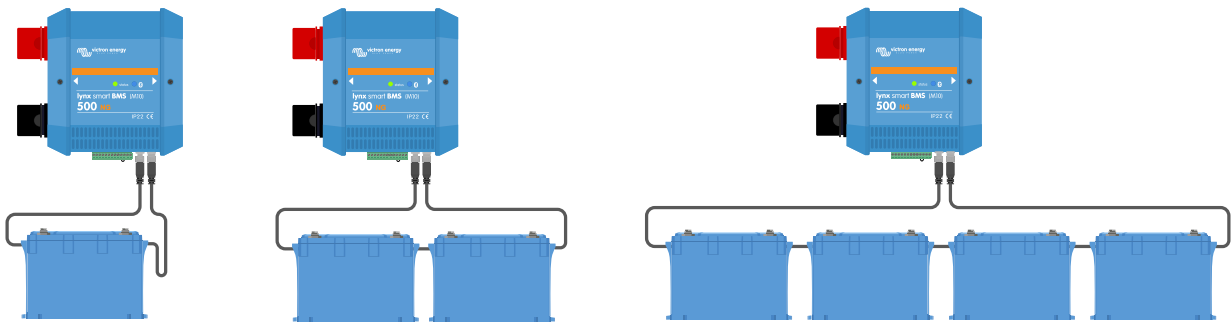

Lynx Smart BMS NG battery BMS cable connection examples

3.4.4. Connect the Multi-connector

The multi-connector is the green connector on the bottom of the Lynx Smart BMS NG. The connector of the Lynx Smart BMS NG has 13 pins, numbered from left to right, starting with pin 1 and ending with pin 13. Pin 12 and 13 are reserved for future functionality. Do not connect anything to them.

See the Appendix for a [table with pin-out and description \[49\]](#).

The multi-connector can be pulled out of the Lynx Smart BMS NG, allowing for easy wiring.

The Remote on/off (pin 10 and 11) of the terminal are interconnected with a wire loop by default. If the Remote on/off connection is used with a simple on/off switch, remove the loop and wire as desired.

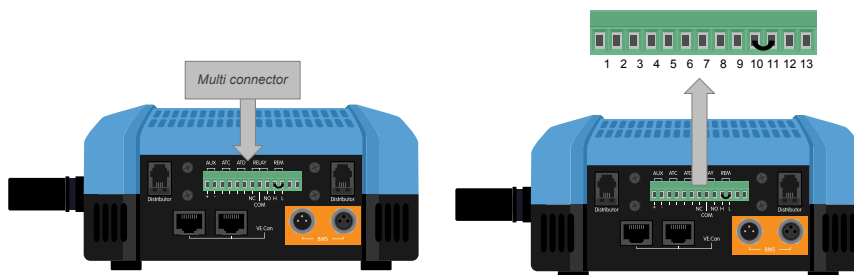

Multi-connector location

3.4.5. Connect ATC/ATD controlled loads and chargers

The ATC (allow-to-charge) and ATD (allow-to-discharge) are potential-free dry contacts of the multi-connector that can control chargers and loads in the system, provided they have a remote on/off connector and are wired appropriately. They can be used in several ways.

A common example is by providing +12V wired from AUX + (equal to system voltage) to pin 3 and pin 5. An active high signal is then delivered to the connected remote H ports of the chargers and loads via pin 4 respectively pin 6. In case of a low cell voltage, ATD opens the contact between pin 5 and pin 6. The load is then switched off and further discharge is prevented. If the temperature is too low to charge, the ATC contact between pin 3 and pin 4 opens and switches off the chargers.

Instead of using system voltage on AUX +, system negative can be used on AUX - to generate an active L signal. The functionality is the same as described above, except that the low signal ensures that the loads and chargers are switched off. This active L signal can then be connected to the remote L terminals of a charger or load. In contrast to the H signal, system negative is also present if the contactor opens and the Lynx Smart BMS NG goes into OFF mode.

Another option is to use the ATC and ATD contacts as remote switches, for example, to control a Smart BatteryProtect to turn off loads in the event of low cell voltage or a charger in the event of low temperature.

See the wiring examples below:

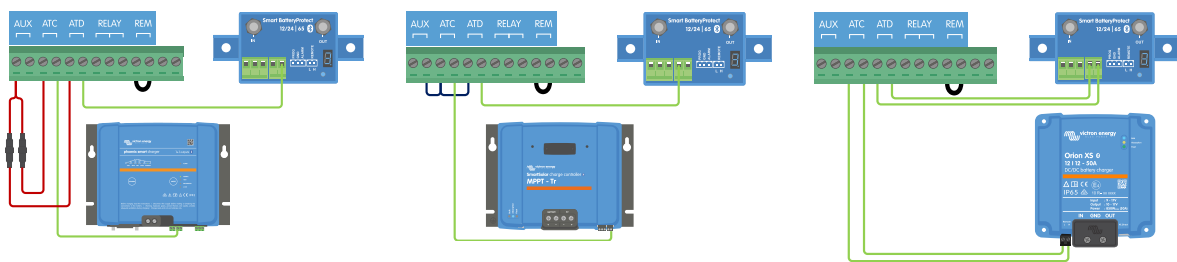

 For the system to operate correctly, it is essential that all loads and chargers can be controlled by either DVCC or the ATC and ATD signals. Ideally, wire the ATC and ATD signals to a device's remote on/off connector, or, if that is not available, a Smart BatteryProtect or Cyrix-Li can be used.

3.4.6. Wiring the Remote on/off

Instead of the pre-installed wire loop between pin 10 and pin 11, a simple on/off switch can be wired to remotely turn the Lynx Smart BMS NG on and off. Alternatively, terminal H (pin 10) can be switched high (typically battery positive), or terminal L (pin 11) can be switched low (typically battery negative) to remotely control the Lynx Smart BMS NG.

The required and maximum voltage levels for remote switching via the H or L pin are listed in the following table:

H pin On level	L pin On Level	Maximum voltage	Minimum voltage
>3 V	<5 V	70 V	-70 V

See the below example for the correct wiring:

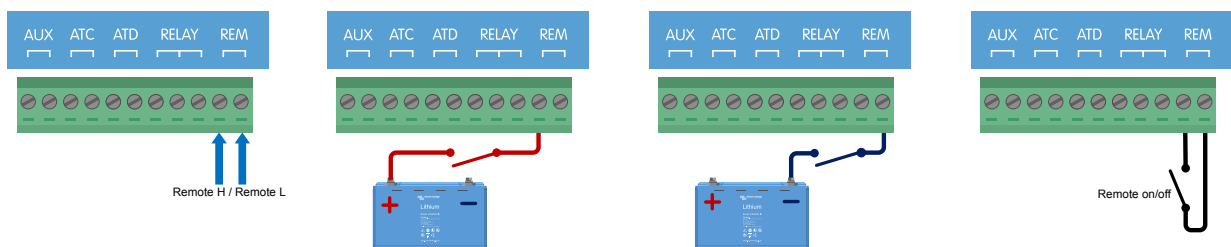

Simple remote on/off switch wired between pin 10 and pin 11, or battery positive (or negative) and pin 10 (or pin 11). Pin 12 and 13 are not shown.

 For the Lynx Smart BMS NG to operate, the connection between pin 10 and pin 11 must be closed, or terminal H (pin 10) must be switched high (typically battery positive), or terminal L (pin 11) must be switched low (typically battery negative).

3.4.7. Programmable relay wiring

The programmable relay is an SPDT relay (Single Pole, Double Throw) with 3 contacts:

- Common (COM)
- Normally Open (NO)
- Normally Closed (NC)

The relay makes contact between COM and NC when the relay is not active, while COM and NO make contact when the relay is activated.

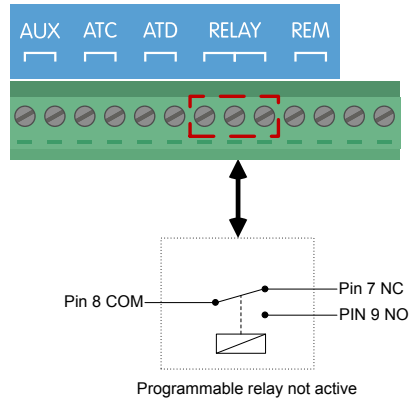

Depending on the Relay mode setting (Alarm relay or Alternator ATC*) in the VictronConnect app, an audible (buzzer or external speaker) or visible device (LED signal) or the signal line (usually the ignition wire) for the ATC signal of an external alternator regulator can be connected.

 *The Alternator ATC function is mainly intended for existing systems where the ATC signal has already been wired to an external alternator regulator. For new system designs, this function is not required. It remains available only to ensure compatibility with older installations.

3.4.8. Connect the GX device

Connect the VE.Can port of the Lynx Smart BMS to the VE.Can port of the GX device using an RJ45 cable.

Multiple VE.Can devices can be daisy chained, but ensure the first and the last VE.Can device both have a VE.Can RJ45 terminator installed.

Power the GX device from the AUX + and AUX – terminals of the Lynx Smart BMS NG.

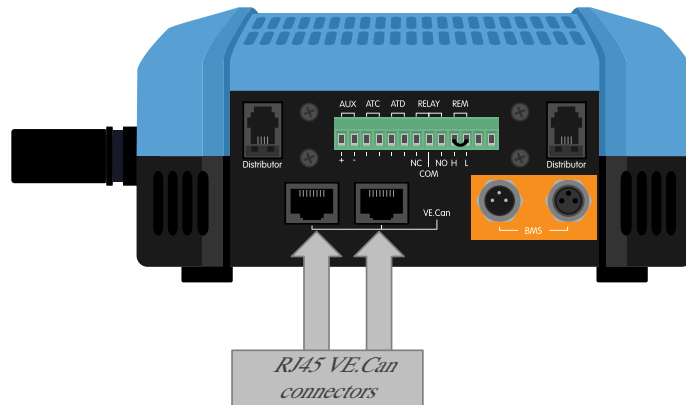

Location of the VE.Can connectors on the Lynx Smart BMS NG

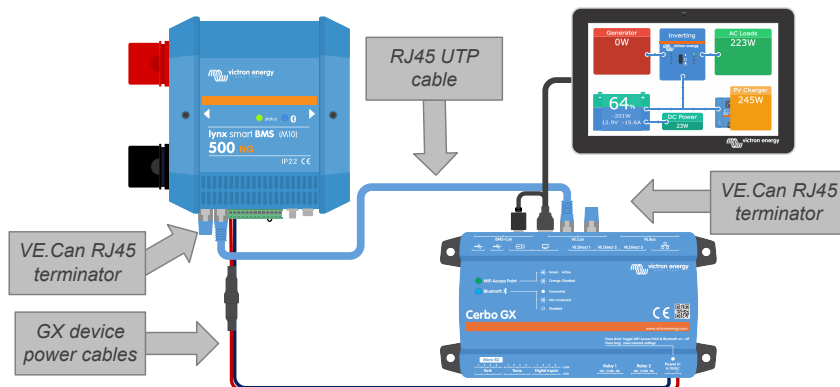

Wiring example Lynx Smart BMS NG and a Cerbo GX with GX Touch

3.5. System examples in detail

3.5.1. Lynx Smart BMS NG , 2x Lynx Distributor and Lithium NG batteries

The heart of this system is a Lynx Smart BMS NG with two Lynx distributors and a Cerbo GX with a GX Touch panel. These devices continuously monitor the batteries, fuses, connected loads, chargers, and inverter/charger(s).

A typical system can contain the following components:

- Lynx Smart BMS NG with built-in contactor and battery monitor.
- Lynx Distributor with 2 fused paralleled Lithium NG batteries and identical cable lengths for each battery (up to 50 batteries can be used per system - see the [Lithium NG battery manual](#) for details).
- Lynx Distributor with fused connections for chargers, inverter/charger(s) and loads.
- A Cerbo GX (or other GX device).

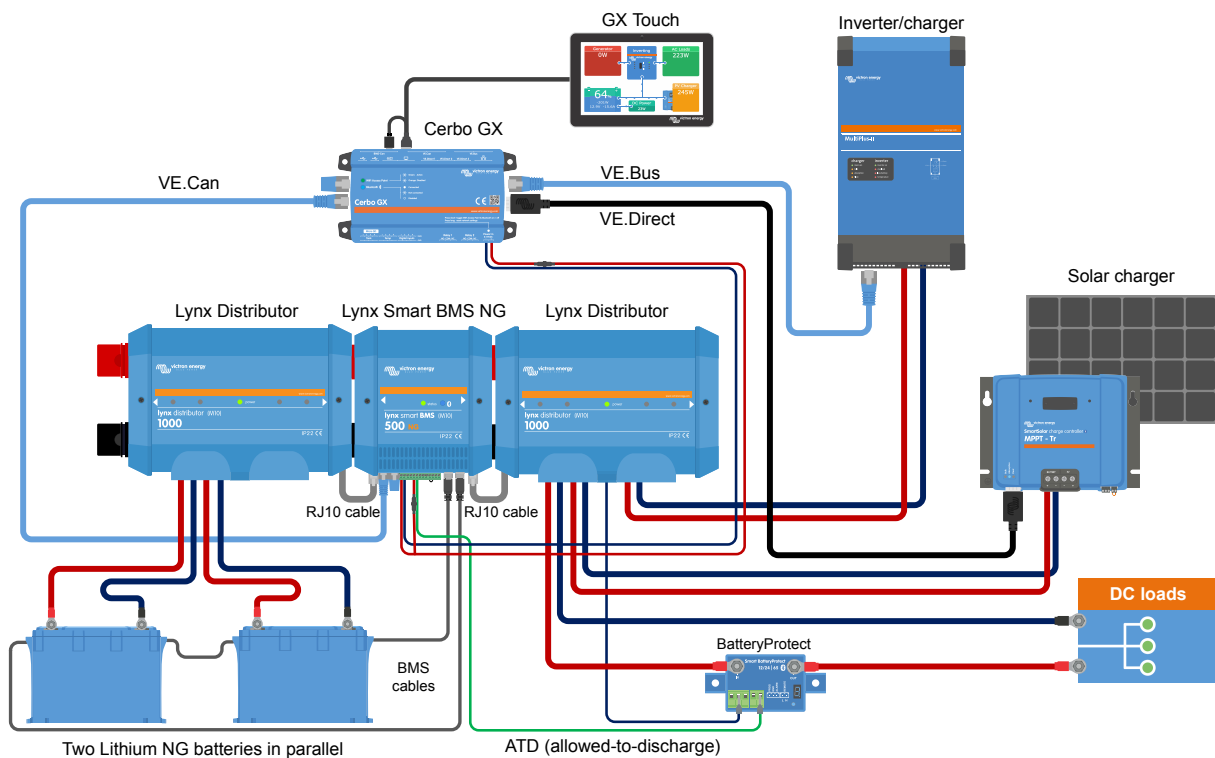

System with Lithium NG batteries, Lynx Smart BMS NG and two Lynx Distributors

3.5.2. Lynx Smart BMS NG, 1x Lynx Distributor and Lithium NG batteries

The same as before, but this time with a single Lynx Distributor on the load side of the Lynx Smart BMS NG and the Lithium NG battery connected directly to the input of the BMS. This is useful if only a single Lithium NG battery or a single series string of Lithium NG batteries is used. Otherwise the same components are used.

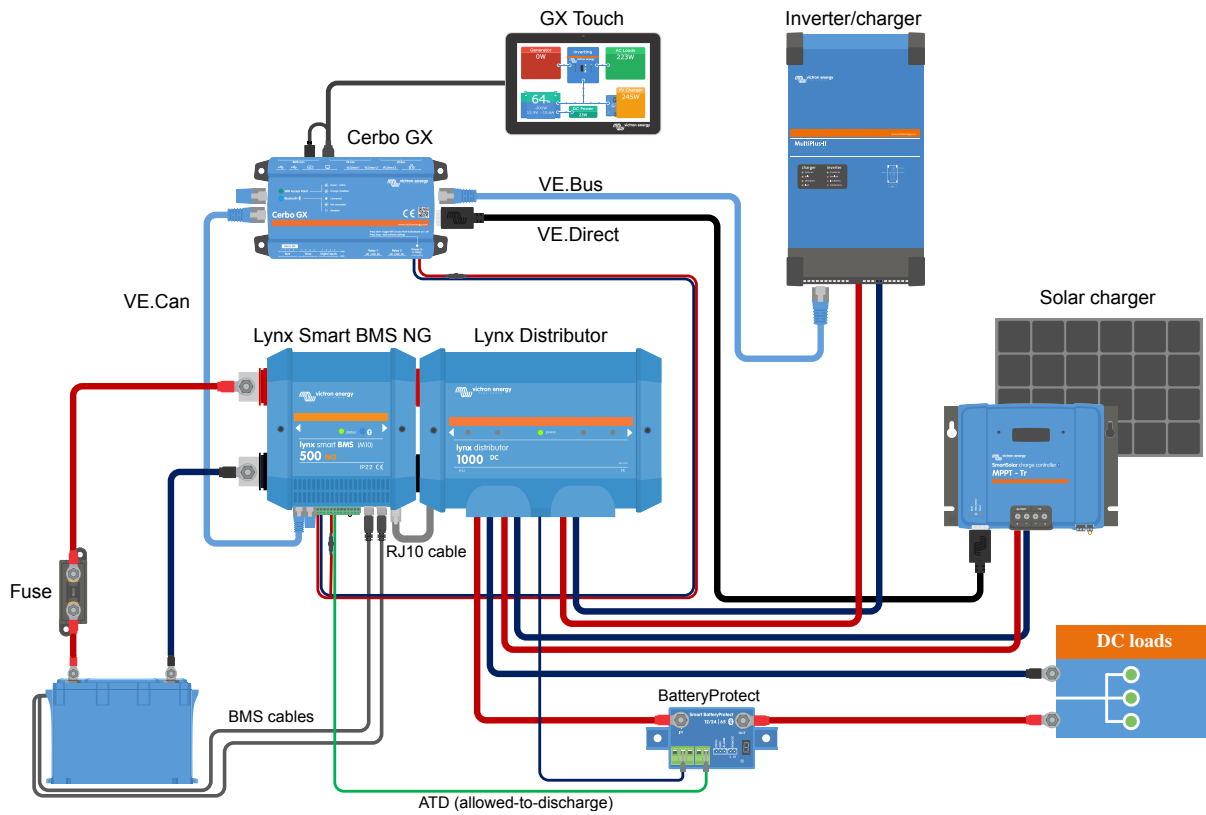

System with a Lynx Smart BMS NG and a single Lynx Distributor

3.5.3. Lynx Smart BMS NG only

For a very slim-line system, the Lynx Smart BMS NG can be used alone. This is useful if the system contains a single lithium battery or a single series string of lithium batteries together with a simple DC system.

Please also note that no GX device is used. It is not absolutely necessary for the operation of the Lynx Smart BMS NG. However, without a GX device it is impossible to control compatible inverter/chargers and MPPTs via DVCC.

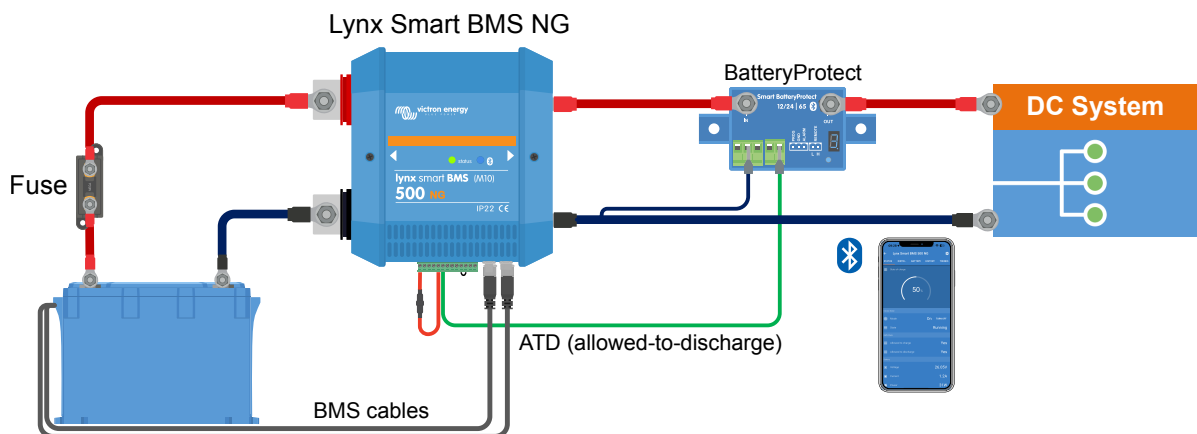

System with a Lynx Smart BMS NG, without other Lynx modules and GX device.

4. Configuration and settings

4.1. Power up for the first time

The Lynx Smart BMS NG will power up when a battery is connected, the wire loop is placed between pins 10 and 11 of the multi-connector, or the Remote on/off switch is switched on.

When first powered on and after a “Reset to defaults” (via the VictronConnect app), the Lynx Smart BMS NG automatically determines and sets the following settings:

- System voltage, 12, 24 or 48V, by measuring the battery voltage
- Number of batteries in parallel, series and parallel/series configuration
- Number of battery cells per battery

4.2. Update firmware

A firmware update of the Lynx Smart BMS NG can be performed in two different ways:

- Via the VictronConnect app
- Via the VRM: Remote Firmware Update feature (requires an internet-connected GX device)

Notes on firmware updating in general

- Newer is not always better
- Don't break it if it works
- Be sure to read the changelog before starting the update process. The changelog can be downloaded from [Victron Professional](#).

Therefore, use this feature with care. Our main advice is not to update a running system unless there are problems with it or before the first startup.

Notes on updating the Lynx Smart BMS NG firmware

- A firmware update will not result in a temporary system shutdown. During the update, the Lynx Smart BMS NG keeps all contacts and the contactor in the same state as when starting the update. If the update fails, ATD/ATC and contactor open after 120 seconds for safety reasons. This also gives time to try updating again.
- Updating the firmware always starts a new full charging cycle despite the SoC threshold setting, which means that the charge voltage limit (CVL) is automatically adjusted from 13.5V to 14.0V (28.0V or 56.0V).

Updating firmware via VictronConnect

Please note the following before performing a firmware update via VictronConnect:

1. For detailed instructions on updating the firmware, see the [firmware update chapter](#) in the VictronConnect manual.
2. If a newer firmware version is available, the VictronConnect app (make sure the VictronConnect app is the latest version) will notify you as soon as a connection with the Lynx Smart BMS NG is made.

Updating firmware via VRM: Remote firmware update

Features:

- Remotely update internet-connected products straight from the VRM Portal
- No need to install any software
- Works from laptop, tablet & phone
- There is no need to find the right firmware file: the system has all of them and will clearly indicate that a newer version is available.

See the [VRM: Remote firmware update manual](#) for detailed instructions.

4.3. Lynx Smart BMS NG settings

Once powered up, use the VictronConnect app to configure the BMS settings.

Check the Battery voltage setting (12, 24 or 48V):

- This will have been detected automatically; double-check it.

Check the Battery capacity setting:

- This will have been detected automatically; double-check it.

Check the Number of batteries in parallel:

- This will have been detected automatically; double-check it.

Check the Pre-alarm mode setting:

This setting is automatically configured upon initial power-up and after a "Reset to defaults". It is enabled by default.

- **Enabled:** Recommended setting. A visual or audible device linked to the programmable relay is activated in case of a pre-alarm.

- **Disabled:** If disabled, it will ignore the discharge current limit at pre-alarm setting.

Set the Relay mode:

The programmable relay has two operation modes: Alarm relay and Alternator ATC.

- When set to Alarm relay mode, the Alarm relay setting becomes active and continuous or intermittent operation can be selected. In intermittent operation, the relay switches on and off every 0.8 seconds.
- When configured for Alternator ATC mode, the relay activates only when the contactor is closed. Before the contactor is opened, Alternator ATC is opened first and 2 seconds later the contactor. These 2 seconds ensure that the alternator regulator is switched off before the battery is disconnected from the system.

DVCC settings:

DVCC is forced on and cannot be turned off. However, a few settings can be changed, which are described below.

Please note that these settings only affect compatible DVCC devices such as Victron inverter/chargers, Orion XS DC-DC battery chargers and Solar MPPT chargers.

- **Discharge Current Limit at pre-alarm:** Default is "No". If set to "Yes", the discharge current limit is already set to 0A in the event of a pre-alarm, while the ATC contact remains closed. In this way it's possible to save some battery power for essential DC loads, for example on boats such as lighting, bilge pump and navigation.
- **Absorption time:** is set to 2 hours by default. This can be adjusted if necessary.
- **Repeated absorption interval:** the number of days at which a new full charging cycle is started if the battery SoC does not fall below the SoC threshold. The default is every 30 days and can be adjusted if required.

- **SoC threshold:** is set by default to 70%. This is the threshold at which the Lynx Smart BMS NG starts a new full charging cycle. This can be adjusted if required.

A new charge cycle means that the CVL (charge voltage limit) is increased from 13.5V to 14.0V (28.0V, 56.0V).

In addition to the SoC threshold, a new charging cycle is started after a firmware update, when the battery voltages are below 12V/24V/48V (3V per cell) or when a low cell voltage is detected.

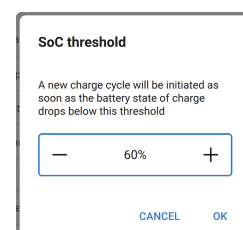
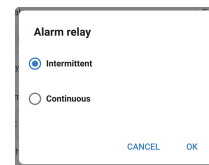
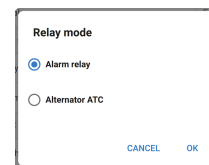
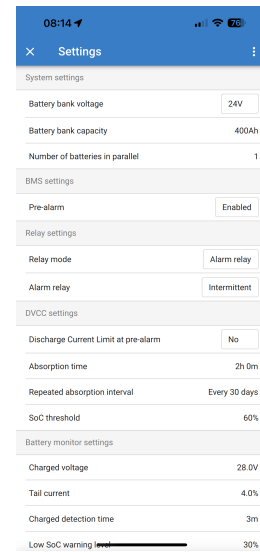

Battery monitor settings:

Unlike other battery monitors, the Lynx Smart BMS NG battery monitor settings are mostly fixed and not customisable. This is because the Lynx Smart BMS NG is always used together with Victron Lithium NG batteries, and many battery monitor parameters are known because they relate to the battery type.

The following settings are adjustable. A full list of all settings used can be found in [List of battery monitor settings \[49\]](#) in the appendix.

- **Charged voltage:** the voltage at above which the battery monitor synchronises and resets the SoC to 100%. For synchronisation to happen, the tail current and charged detection time conditions need to have been met as well. The default is set to 14.0V (28.0V, 56.0V) and can be adjusted if necessary. In case the system voltage setting is changed, the charged voltage setting needs to be adjusted as well.
- **Tail current:** the current at below which the battery monitor synchronises and resets the SoC to 100%. For synchronisation to happen, the charged voltage and charge detection time conditions need to have been met as well. The default is set to 4% and can be adjusted if needed.
- **Charged detection time:** is the time passed after which the battery monitor synchronises and resets the SoC to 100%. For synchronisation to happen, the charged voltage and tail current conditions need to have been met as well. The default is set to 3 minutes and can be adjusted if necessary.

- **Discharge floor:** this parameter has two functions:

Its primary use is to set the minimum SoC to determine how far the battery may be discharged and to ensure that there is enough energy left for self-discharge after a low SoC shutdown.

A limited depth of discharge is good for battery health, but also provides backup power to keep the system running, e.g. until sunrise for solar systems.

When the set discharge floor is reached, a low SoC alarm will be issued. The BMS then switches to OFF mode with a delay of 5 minutes if no sufficient charge voltage has been detected on the system side of the BMS by then.

Setting the discharge floor to zero (not recommended), disables this feature.



The discharge floor prevents full discharge and should be chosen so that there is always enough energy in the battery for self-discharge before the battery can be recharged.

Example: A 10% discharge floor still provides enough stored energy for the self-discharge of a 200Ah battery to last about 9 months without recharging.

It is as used in the calculation for the 'Time remaining' or 'Time-to-go' value displayed in the VictronConnect app, a connected GX device or on the VRM portal. The battery monitor uses the actual discharge current to calculate the time it takes to reach the set discharge floor.

- **Low SoC warning level:** the level at which a warning is issued before the discharge floor has been reached.
- **State of charge:** manually set the current state of charge.
- **Synchronise SoC to 100%:** manually synchronise SoC to 100%.

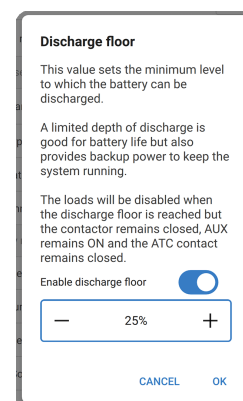

4.4. Lynx Distributor settings

These instructions only apply if the system contains one or more Lynx Distributors.

Each Lynx distributor must be addressed and set to A, B, C or D. This is done via a 2-way dip switch located inside the Lynx Distributor. Refer to [chapter 6.1.3. Addressing Lynx Distributor](#) in the Lynx distributor manual.



If the dip switches have been accidentally programmed incorrectly or need to be reprogrammed to a different address after commissioning the Lynx Smart BMS NG, you must restart the BMS (OFF mode and back to Standby or ON mode). This action is necessary to correctly adopt the Lynx Distributor status in VictronConnect and the GX device. Restarting the BMS will also reset the error message "W-D02: Communication with Distributor [A, B, C, or D] lost" in VictronConnect and clear the Lynx Smart BMS alarm "Distributor [A, B, C, or D] connection lost."

Use the VictronConnect app to give each fuse a custom name (maximum 16 characters). If the fuse name is empty (0 characters), the fuse will be disabled and ignored for monitoring.

1. Navigate to the Settings page by clicking the cog wheel icon in the top right.
2. On the Settings page, scroll down to the Lynx Distributor settings.
3. Tap on a distributor name. A new menu opens with all 4 fuses.
4. Tap on a fuse to assign a custom name and/or to disable the fuse manually from monitoring.

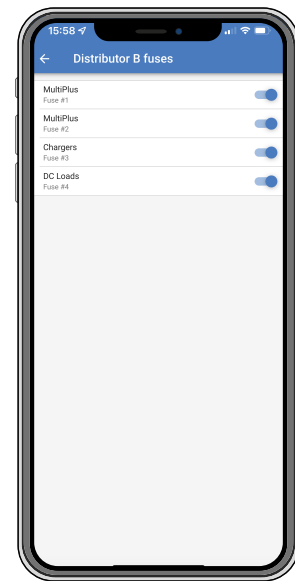
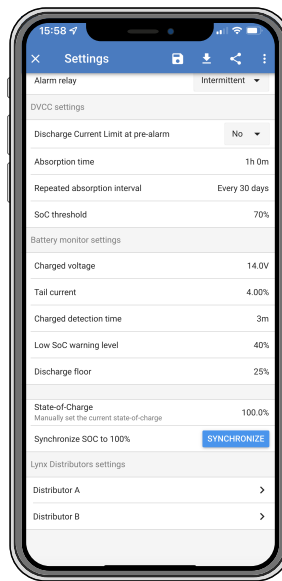

4.5. Bluetooth reactivation

If Bluetooth has been deactivated on the Lynx Smart BMS NG in VictronConnect, for example for security reasons, it can only be reactivated via a GX device in the BMS settings menu.

To reactivate Bluetooth:

1. On the GX device, open the Remote Console.
2. Go to Settings → Devices → [Your_Lynx_Smart_BMS_NG] → Settings.
3. Enable Bluetooth.

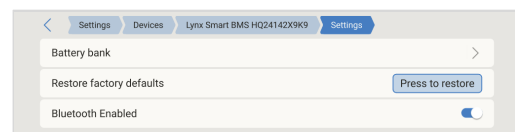

5. Commissioning, operation and monitoring

5.1. Commissioning the Lynx Smart BMS NG

Commissioning sequence:

1. Check the polarity of all battery cables.
2. Check the cross-sectional area of all battery cables.
3. Check that each battery has the most up-to-date firmware.
4. Check that if batteries have been connected in series, each battery has been fully pre-charged (refer to battery manual).
5. Check if all battery cable lugs have been crimped correctly. Check if all battery cable connections are tight (don't exceed maximum torque). Tug slightly on each battery cable and see if the connections are tight.
6. Check all BMS cable connections and make sure the connector screw rings are screwed all the way down.
7. Check if each paralleled battery is fused or that each paralleled battery series string is fused.
8. If a GX device is used, check if the VE.Can cables and terminator have been placed and the device is powered from the AUX voltage output of the Lynx Smart BMS.
9. Power the Lynx Smart BMS by connecting the battery supply or placing the battery fuses and, if applicable, by switching the remote on/off switch to "on".
10. Check that the load pre-charge is complete, the contactor is closed, and the loads are energised.
11. Connect to VictronConnect and make sure the Lynx Smart BMS NG has the latest firmware (see the [Update firmware chapter](#) for details) and that all settings have been made, particularly that the battery capacity and the number of paralleled batteries are set correctly.
12. Check that the system voltage has been set correctly.
13. Check if the fuse names of the Lynx Distributor (if applicable) are correctly named.
14. If a GX device is connected, check that it is powered from the Lynx Smart BMS AUX terminals.
15. Check that the Lynx Smart BMS displays correctly on the GX device.
16. Disconnect a random BMS cable and verify that the BMS is turning off all charge sources and loads. Then reconnect the BMS cable.
17. Turn on a load and check that the current is a negative current displayed on the GX device or the VictronConnect app.
18. Fully charge the batteries and check that a 100% state of charge is displayed.

5.2. Powering up

The Lynx Smart BMS NG will power up when a battery is connected to the battery terminals and the Remote on/off switch is turned on (or the wire loop is placed in the remote on/off terminal).

The power-up sequence follows these steps:

- **System check:** A self-test that checks the internal and external voltages and contactor.
- **Pre-charge loads:** The pre-charge circuit will pre-charge capacitive loads such as inverters or inverter/ chargers before the contactor closes to prevent high inrush current.
- **Contactor closes:** The Lynx Smart BMS NG is operational and the power to the Lynx Distributor(s) is turned on.

Operational

Once powered up, the contactor is closed. The green status LED, together with the blue Bluetooth LED on the Lynx Smart BMS NG and the green power LED on the Lynx Distributor(s), is illuminated.

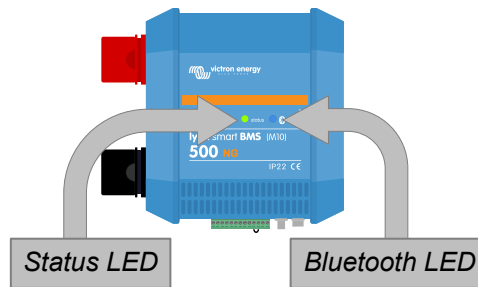

5.3. BMS operating modes

The BMS in the Lynx Smart BMS NG communicates with the batteries and safeguards them against low or high cell voltage and low or high temperatures. The battery reports such events to the Lynx Smart BMS NG, which takes the necessary action by turning off loads and/or inverter/chargers and either turning the Lynx Smart BMS NG off or on again, fully automatically or manually.

The Lynx Smart BMS NG has 3 modes of operation:

ON

This is the normal operating mode. All interfaces are operational, and the contactor is closed. If the Lynx Smart BMS NG was off due to low cell voltage or low SoC shutdown, it will exit OFF mode and return to ON mode when

- it detects a charging voltage >11.7V (>23.4V for a 24V system or >46.8V for a 48V system) than the battery voltage on the system side or
- when all cell voltages are higher than 3.2 V in case of a low cell voltage shutdown or
- when all cell voltages are higher than 3.37V in case of a low SoC shutdown or
- when it is turned back on via the Remote on/off switch or
- when it is turned back on via the VictronConnect app.

The mode is also ON for a duration of 5 minutes with no charge voltage supplied when a Low Cell Voltage alarm was issued.

OFF

Lowest power mode. All interfaces are off, and the contactor is opened. This mode is used to prevent damaging batteries by draining them too low.

OFF is the mode the LSB will enter when using the Remote on/off switch or the soft switch in the VictronConnect app.

The Lynx Smart BMS NG will also switch to OFF mode with a 5-minute delay if:

- one or more cells fall below 2.8V, and no charge voltage has been detected during this time to prevent further discharge or
- when the set [discharge floor](#) is reached and, by then, no sufficient charging voltage has been detected on the system side of the BMS.

Standby

The Lynx Smart BMS NG can be put into Standby mode via the soft switch in the VictronConnect app or via the GX device and is used when the boat is docked, or the RV is parked to prevent accidental discharging and charging from sources on the system side. All systems will be shut down except for equipment powered by the AUX power port, which we recommend for powering the GX device. This mode is not intended to be used when the boat or RV is in storage for a longer period. Therefore, when a low cell voltage or low SoC (as determined by the discharge floor setting in the BMS) is detected, the Lynx Smart BMS NG will automatically switch to OFF mode to prevent further battery discharge.



The basic requirement for the soft switch to work in VictronConnect or in the GX device is that the contact between pins 10 and 11 of the multi-connector is bridged with either a wire loop or a remote on/off switch.

See the below tables for an overview of all 3 operating modes, how to switch them manually and the status of the interfaces:

Mode	Main contactor	ATC	ATD	AUX power output	VE.Can port	Bluetooth	Intended use
On	Closed	On	On	Powered	Functional	On	Normal operating mode. All interfaces are operational.
Standby	Open	Off	Off	Powered	Functional	On	All systems will be shut down, except for equipment powered by the AUX power port from which we recommend for powering the GX device.
Off	Open	Off	Off	Off	Off	On	Lowest power mode. All interfaces are off, and the contactor is opened.

Lynx Smart BMS device modes and status of the interfaces

Mode	Soft switch VictronConnect app	Soft switch GX device	Hard wired Remote on/off switch
ON	Yes	Yes*	Yes
Standby	Yes	Yes	No
OFF	Yes	No	Yes

* Only possible from Standby mode

How to manually switch device modes

5.4. Lynx Smart BMS NG trigger

This section describes the behaviour of the Lynx Smart BMS NG in case the pre-alarm threshold is reached or a low cell voltage or low-temperature event is triggered.

The pre-alarm threshold, low/high cell voltage and low/high temperature limits are hard-coded into the battery and cannot be changed.

Pre-alarm

If a cell voltage drops and reaches the pre-alarm threshold, the programmable relay will activate, if configured to Alarm relay mode. This will give an advanced warning of an impending low cell voltage and before the loads are disabled. Pre-alarm is indicated by the red LED flashing 3 times every 4 seconds. The Lynx Smart BMS NG ensures a minimum delay of 30 seconds between enabling the pre-alarm and switching off the loads.

Low cell voltage cut-off

If the cell voltage gets too low and has reached the low cell voltage threshold, the ATD contact opens and turns off all loads. If the Lynx Smart BMS is connected to a GX device, DVCC-compatible inverters connected to the same GX device are also turned off. After 5 minutes without sufficient charge voltage on the system side of the BMS, it will shut down.

Low temperature or high cell voltage cut off

If a cell voltage becomes too high and reaches the high cell voltage threshold (3.60V hard-coded in the battery) or the low-temperature threshold, the ATC contact opens and turns off all chargers. If the Lynx Smart BMS NG is connected to a GX device, DVCC-compatible chargers connected to the same GX device will also be turned off.

5.5. Battery monitor operation

The Lynx Smart BMS NG has a built-in battery monitor. It measures battery voltage and current. Based on these measurements, it calculates the state of charge and time to go and keeps track of historical data, such as the deepest discharge, average discharge, and number of cycles.

5.6. Monitoring & Control

A BMS is always required to monitor and control the battery.

Depending on the communication path, the BMS and battery parameters, as well as the fuse status of the Lynx Distributor(s), can be accessed in different ways:

1. Via the [VictronConnect app](#) over Bluetooth.
2. Via the [VictronConnect app](#) using [VictronConnect Remote \(VC-R\)](#): This requires a GX device connected to a Lynx Smart BMS NG, with data transmitted to the VRM portal. For details, refer to the GX device manual.
3. Via the [VRM Portal](#): This requires a GX device connected to a Lynx Smart BMS NG, with data transmitted to the VRM portal. For details, refer to the GX device manual.
4. Directly via a connected GX device.

Depending on the transmission path, the following parameters can be read out:

BMS Parameter	Bluetooth	GX device	VC-R	VRM
State of charge		Yes		
Mode		Yes		No
State		Yes		
Allowed to charge		Yes		
Allowed to discharge		Yes		
Battery voltage		Yes		
Battery current		Yes		
Battery power		Yes		
Consumed Ah		Yes		
Time remaining		Yes		No
Relay status		No		Yes

History parameter	Bluetooth	GX device	VC-R	VRM
Deepest discharge		Yes		
Cumulative Ah drawn		Yes		
Discharged energy		Yes		
Charged energy		Yes		
Synchronisations		Yes		
Total charge cycles	No	Yes	No	Yes
Number of full discharges	No	Yes	No	Yes
Min battery voltage		Yes		
Max battery voltage		Yes		
Min cell voltage		Yes		
Max cell voltage		Yes		
Battery temperature		Yes		Yes*
Last error		Yes		
* Via custom widget				

Battery Parameter	Bluetooth	GX device	VC-R	VRM
Balancer status		Yes		
Min and max cell voltage		Yes		
Min and max cell temperature		Yes		
Number of batteries		Yes		

Battery Parameter	Bluetooth	GX device	VC-R	VRM
Number of battery cells			Yes	
Number of batteries in series			Yes	
Number of batteries in parallel			Yes	
Serial number	Yes		No	
Capacity	Yes		No	
Firmware version	Yes		No	
Battery voltage			Yes	
Battery temperature			Yes	
Battery current	Yes		No	
Individual cell voltages	Yes		No	

Distributor parameter	Bluetooth	GX device	VC-R	VRM
Distributor [A..D] status		Yes		No
Distributor [A..D] Fuses		Yes		No

5.6.1. Monitoring the BMS via VictronConnect and VC-R

The VictronConnect app can be used to monitor the batteries, Lynx Distributor fuse status and history via Bluetooth or VC-R. The table in the previous section lists the available parameters per connection type.

To check the BMS or battery parameters, do the following:

1. Open the VictronConnect app, and from the Device List, tap on the Lynx Smart BMS NG.
2. Tap on one of the menu tabs to view the corresponding parameters and their values.
3. By tapping the Mode button in the Status tab and the Battery number button in the Battery tab, you can change the status of the BMS (switching the BMS off or in standby mode) or select the battery whose parameters you want to read.

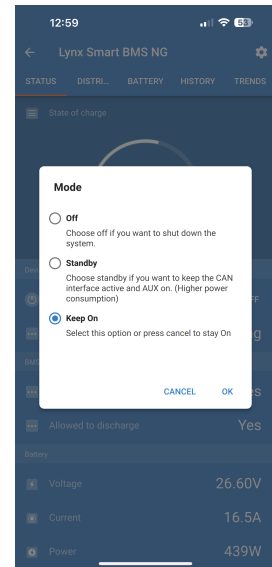
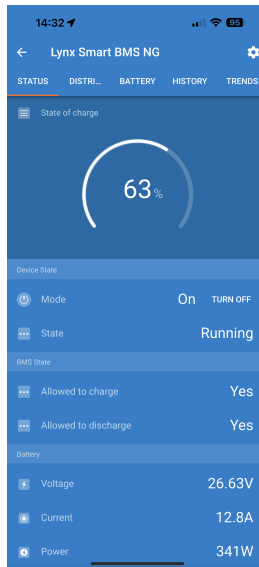

Note that warning, alarm or error messages are only shown while actively connected to the BMS via VictronConnect. The app is not active in the background nor when the screen is off.

VictronConnect-Remote (VC-R) support

VictronConnect-Remote functionality enables the Lynx Smart BMS NG to be accessed remotely. The prerequisite for this is that the BMS is connected to a GX device that has a (internet) connection to the VRM Portal.

This powerful feature allows full product configuration (except Bluetooth) and monitoring from practically anywhere in the world using the VictronConnect app. The user interface experience is just like the Lynx Smart BMS NG were connected locally using Bluetooth.

1. Open the VictronConnect app and tap on the VRM tab.
2. Tap on the installation that includes the system with the Lynx Smart BMS NG.
3. Tap on the Devices tab. A list of all available VE.Direct and VE.Can devices is displayed, including the Lynx Smart BMS NG.
4. Tap on the Lynx Smart BMS NG. The Lynx Smart BMS NG status screen is now displayed as if it were connected locally using Bluetooth

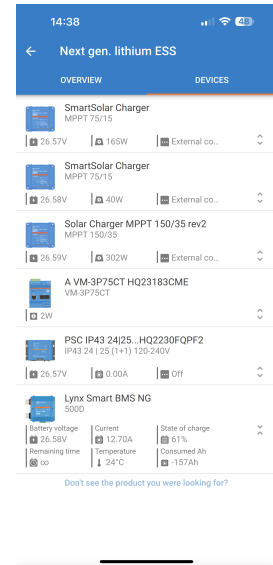
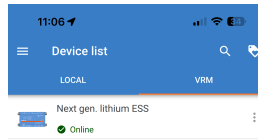

5.6.2. VictronConnect Instant Readout

Battery voltage, current, state of charge and remaining running time at a glance. See what you want to know in seconds in the VictronConnect app Device list.

The advantage is that the data is available much faster, together with data from other Bluetooth smart devices, and the range exceeds that of a normal Bluetooth connection.

To enable Instant readout:

1. Open the VictronConnect app and tap on the entry for your Lynx Smart BMS NG.
2. Tap on the cog wheel icon in the top right-hand corner.
3. Tap on the 3 dots icon in the top right-hand corner. The Product info screen opens.
4. Enable Instant readout by tapping on the slider. Be careful not to disable Bluetooth.
5. Go back to the local device list. Instant readout is now visible to the Lynx Smart BMS NG.

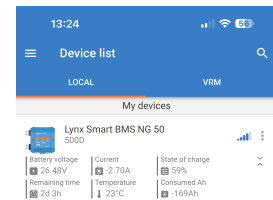
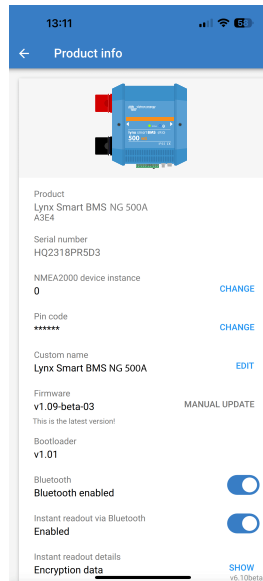

5.6.3. Monitoring the BMS via GX device

BMS and battery parameters, Lynx Distributor fuse status, and history can also be viewed on a GX device via Remote Console when used with a Lynx Smart BMS NG. The table in the previous section lists the available parameters per connection type.

To view BMS or battery parameters:

1. Open the Remote Console.
2. In Devices list, select the Lynx Smart BMS NG to view the general parameters.
3. Scroll down to access additional parameters in the submenus, then select the required submenu.

Settings		Devices	
A VM-3P75CT HQ23183CME	134W	>	
BlueSolar Charger MPPT 150/35 rev2	0W	>	
Diesel	0.0	24°C	41% 20% >
Lynx Smart BMS HQ24142X9K9	49%	26.33V	-0.4A >
MultiPlus-II 24/3000/70-32	Bulk charging >		
Ruuvi Air	774ppm	15.3µg/m³ >	
Shelly A085E3BDD218	Running >		

The following tables list the available submenus and parameters of the Lynx Smart BMS NG on the GX device.

Lynx Smart BMS device menu

- **Switch:** Allows to switch the BMS into Standby mode or switch it on.
- **State:** Shows the current operating state of the BMS.
- **Error:** Shows the active error code and description, if any.
- **Battery bank error:** Shows battery bank-related errors. Displays None if no fault is present.
- **Battery:** Shows the main battery values: voltage, current, and power.
- **State of charge:** Shows the battery state of charge (SoC) as a percentage.
- **Battery temperature:** Shows the battery temperature as reported by the battery.
- **Consumed AmpHours:** Shows the accumulated consumed capacity (Ah) relative to a full battery.
- **Time-to-go:** Estimated remaining runtime at the current load, based on battery capacity, discharge rate and Discharge floor setting.
- **Individual Battery Info:** Opens a submenu with per-battery information.
- **Details:** Shows min. and max. cell voltage and temperature.
- **Alarms:** Shows active alarm states reported by the BMS.
- **History:** Shows logged counters and historical data.
- **Settings:** Provides battery bank details, such as nominal voltage and capacity, as well as options to restore the BMS to factory defaults and enable or disable Bluetooth.
- **Diagnostics:** Shows the last four errors.
- **Fuses:** Shows Lynx Distributor fuse status information (when a Lynx Distributor is present in the system and connected via the BMS).
- **IO:** Shows the status of the contactor, as well as the ATC (Allow to Charge) and ATD (Allow to Discharge) signals.
- **System:** Shows system-level information related to the battery.
- **Parameters:** Shows CVL, CCL and DCL limits.
- **Device:** Shows BMS-related information (for example product ID, VRM instance, connection type, and firmware version). A custom name for the BMS can also be assigned here.

Settings > Devices > Lynx Smart BMS HQ24142X9K9		
Switch	On	>
State	Running	
Error	#0 No error	
Battery bank error	None	
Battery	26.44V -0.4A -10W	
State of charge	49%	
Battery temperature	21 °C	
Consumed AmpHours	-106 Ah	
Time-to-go	4d 10h	
Individual Battery Info		>
Details		>
Alarms		>
History		>
Settings		>
Diagnostics		>
Fuses		>
IO		>
System		>
Parameters		>
Device		>

Switch submenu

- **Standby:** See [BMS operating modes \[19\]](#).
- **On:** See [BMS operating modes \[19\]](#)

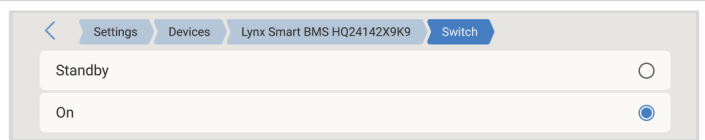

Individual Battery Info submenu

- **Battery:** Select the battery for which the battery information is to be displayed.
- **Serial number:** Shows the serial number of the selected battery.
- **Capacity:** Shows the rated capacity of the selected battery.
- **Firmware version:** Shows the firmware version running on the selected battery.
- **Status:**
- **Voltage:** Shows the battery voltage of the selected battery.
- **Current:** Shows the battery current of the selected battery.
- **Temperature:** Shows the battery temperature of the selected battery.
- **Cell #1..Cell #n:** Shows the voltage and temperature of each cell. The number of cells shown depends on the battery model.

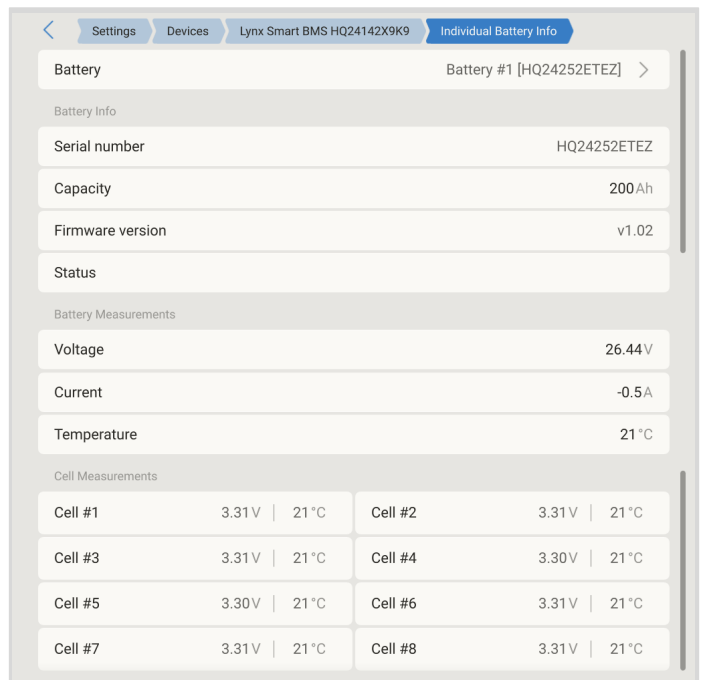

Details submenu

The Details submenu shows the lowest and highest cell voltage, as well as the minimum and maximum cell temperature. The corresponding cell numbers are also displayed.

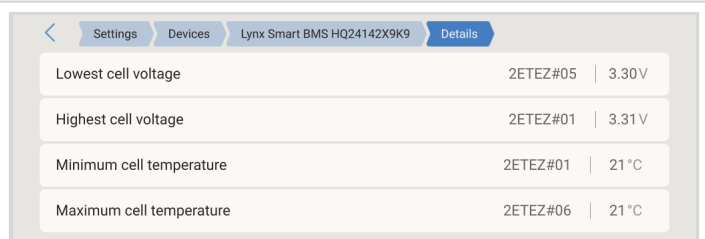

Alarms submenu

The Alarms submenu shows the current status of all monitored alarm conditions of the BMS. Each alarm is displayed with its current state. This is useful for diagnostics to quickly identify the cause of system shutdowns or limited operation. If an alarm becomes active, investigate the cause before continuing operation.

- **High current:** Indicates that the charge or discharge current has exceeded the allowed limit.
- **Low SoC:** Indicates that the state of charge has dropped below the configured threshold.
- **High temperature:** Indicates that the battery temperature has exceeded the permitted limit.
- **High internal temperature:** Indicates that the internal temperature of the BMS has exceeded the permitted limit.
- **Low cell voltage:** Indicates that one or more cells have dropped below the minimum allowed voltage.
- **BMS cable fault:** Indicates a communication fault in the BMS cable.
- **Bad contactor:** Indicates a fault or malfunction of the internal contactor.

Alarm Condition	Status
High current	OK
Low SOC	OK
High temperature	OK
High internal temperature	OK
Low cell voltage	OK
BMS cable fault	OK
Bad contactor	OK

History submenu

The History submenu shows historical battery data and statistical values recorded by the Lynx Smart BMS NG. This menu can be used for diagnostics, performance evaluation, and lifetime analysis.

- **Deepest discharge:** Shows the deepest recorded discharge in Ah.
- **Total charge cycles:** Shows the total number of completed charge cycles.
- **Number of full discharges:** Shows how many times the battery has been fully discharged.
- **Cumulative Ah drawn:** Shows the total ampere-hours drawn from the battery over its lifetime.
- **Minimum voltage:** Shows the lowest recorded battery voltage.
- **Maximum voltage:** Shows the highest recorded battery voltage.
- **Minimum cell voltage:** Shows the lowest recorded cell voltage.
- **Maximum cell voltage:** Shows the highest recorded cell voltage.
- **Time since last full charge:** Shows the time elapsed since the battery was last fully charged.
- **Synchronisation count:** Shows how many times the state of charge has been synchronised to 100 %.
- **Minimum temperature:** Shows the lowest recorded battery temperature.
- **Maximum temperature:** Shows the highest recorded battery temperature.
- **Discharged energy:** Shows the total discharged energy in kWh.
- **Charged energy:** Shows the total charged energy in kWh.
- **Clear History:** Resets the recorded historical data. Use with caution, as this action cannot be undone.

Setting	Value
Deepest discharge	-161 Ah
Total charge cycles	16
Number of full discharges	0
Cumulative Ah drawn	7415 Ah
Minimum voltage	19.35 V
Maximum voltage	29.63 V
Minimum cell voltage	3.09 V
Maximum cell voltage	3.57 V
Time since last full charge	11d 19h
Synchronisation count	18
Minimum temperature	17 °C
Maximum temperature	36 °C
Discharged energy	216.5 kWh
Charged energy	212.1 kWh

Settings submenu

The Settings submenu provides access to battery bank information and basic BMS settings.

- **Battery bank:** Opens the battery bank information menu and shows nominal voltage and capacity.
- **Restore factory defaults:** Restores the Lynx Smart BMS NG to its factory default settings.
- **Bluetooth Enabled:** Enables or disables Bluetooth on the BMS.

Battery bank	>
Restore factory defaults	Press to restore
Bluetooth Enabled	<input checked="" type="checkbox"/>

Diagnostics submenu

The Diagnostics submenu shows the last four recorded errors. This information can be used for troubleshooting and fault analysis.

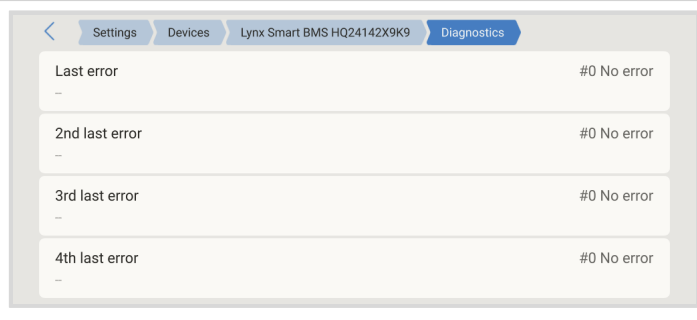

Fuses submenu

The Fuses submenu shows the status of the fuses in the connected Lynx Distributor(s). Each line corresponds to one fused connection and shows:

- the configured name of the connected circuit (for example MultiPlus), and
- the fuse status.

If a fuse is blown or missing, the status will indicate a fault.

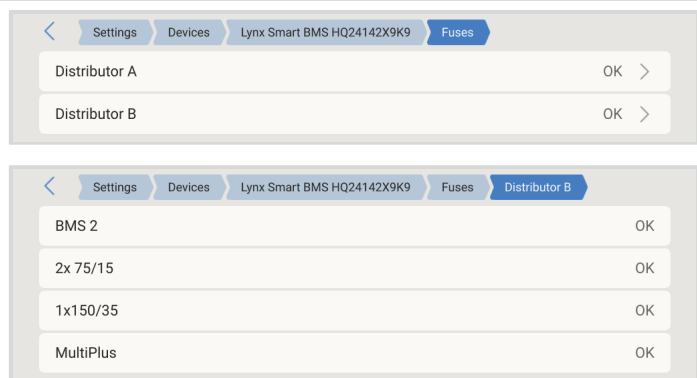

IO submenu

The IO submenu shows the status of the main BMS control signals.

- System switch: Shows whether the BMS system switch is enabled.
- Allow to charge: Shows whether charging is currently permitted by the BMS.
- Allowed to discharge: Shows whether discharging is currently permitted by the BMS.

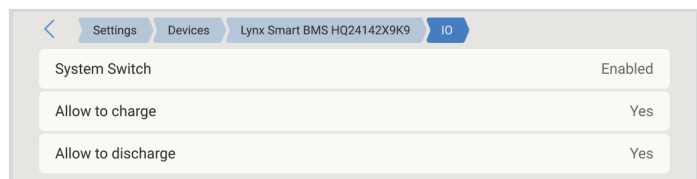

System submenu

The System submenu shows system-level information about the connected battery bank.

- **Capacity:** Shows the configured total battery capacity in Ah.
- **Batteries:** Shows the total number of connected batteries.
- **Parallel:** Shows the number of batteries connected in parallel.
- **Series:** Shows the number of batteries connected in series.
- **Cells per battery:** Shows the number of cells per battery.
- **Min/max cell voltage:** Shows the lowest and highest cell voltage currently measured in the battery bank.
- **Min/max cell temperature:** Shows the lowest and highest cell temperature currently measured in the battery bank.
- **Balancer status:** Shows the current balancing status (for example Balanced).

Parameter	Value
Capacity	200
Batteries	1
Parallel	1
Series	1
Cells per battery	8
Min/max cell voltage	3.30V 3.31V
Min/max cell temperature	21°C 21°C
Balancer status	Balanced

Parameters submenu

The Parameters submenu shows the dynamic charge and discharge limits provided by the Lynx Smart BMS NG. These values may change dynamically. When DVCC (Distributed Voltage and Current Control) is enabled on the GX device, these values are used to control connected chargers and inverter/chargers.

- **Charge Voltage Limit (CVL):** Shows the maximum allowed charge voltage as determined by the BMS.
- **Charge Current Limit (CCL):** Shows the maximum allowed charge current as determined by the BMS.
- **Discharge Current Limit (DCL):** Shows the maximum allowed discharge current as determined by the BMS.

Parameter	Value
Lowest cell voltage	2ETEZ#05 3.30V
Highest cell voltage	2ETEZ#01 3.31V
Minimum cell temperature	2ETEZ#01 21°C
Maximum cell temperature	2ETEZ#06 21°C

Device submenu

The Device submenu shows identification and connection information for the Lynx Smart BMS NG.

The name can be edited to assign a custom name to the BMS.

Parameter	Value
Connection	VE.Can
Product	Lynx Smart BMS 500 NG
Name	Lynx Smart BMS HQ24142X9K9
Product ID	0xA3E4
Firmware version	v1.16
VRM instance	0
Serial number	0448523 HQ24142X9K9

5.6.4. Monitoring the BMS via VRM Portal

Most parameters can also be read via the VRM Portal (requires a GX device in conjunction with a Lynx Smart BMS NG that transmits its data to VRM). The table in the previous section lists the available parameters per connection type.

The battery parameters can be viewed via the 'Advanced' tab. For more information, please see the [VRM Portal documentation](#) on our website.

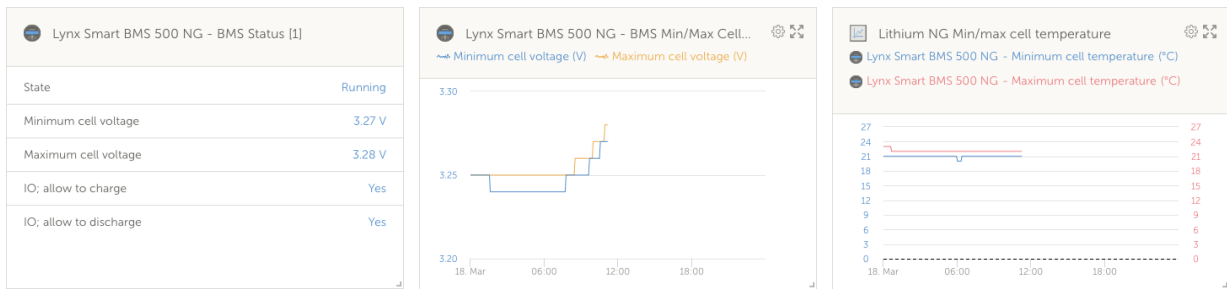

5.7. Battery care

Once the Lynx Smart BMS NG is in operation, it is important to pay attention to the batteries.

These are the basic guidelines:

- Avoid total discharge of the battery at all times and use the discharge floor setting to prevent this.
- Familiarise yourself with the pre-alarm feature and act when the pre-alarm is active to prevent a DC system shutdown.
- Charge your batteries as soon as possible when the pre-alarm is active or the BMS has deactivated loads.
- Minimise the time the batteries spend in a deeply discharged state as much as possible.
- **The batteries need to spend at least 2 hours in absorption charge mode each month to ensure sufficient time in balancing mode.**
- When leaving the system unattended for some time, either keep the batteries charged or make sure the batteries are (almost) full. Then, disconnect the DC system from the battery by disconnecting the positive battery pole.

6. Paralleling Lynx BMSes

6.1. Introduction

A parallel redundant battery bank can be created by combining multiple Lynx Smart BMS and Lynx BMS NG units with their associated battery banks. This innovative feature significantly enhances lithium battery systems by multiplying the maximum energy storage capacity and supporting higher currents. More importantly, it introduces redundancy, ensuring that the system remains operational even if one battery bank fails. This redundancy is crucial for maintaining a continuous power supply and operation.

Key features

- **Increased capacity and redundancy:** By paralleling battery banks, the system can handle higher currents and remain operational even if one battery bank fails.
- **Extended compatibility:** In these configurations, Lynx Smart BMS units can be mixed with Lynx BMS NG units, allowing for systems that combine battery banks with Lithium Smart and Lithium NG batteries. However, only Lynx Smart BMS units with the same current rating may be used in parallel (e.g., 500A + 500A or 1000A + 1000A, but not 500A + 1000A).
- **Automatic error handling:** If a battery bank encounters an error, it will disconnect while the remaining battery banks continue to operate. This ensures a continuous power supply and reduces the risk of system shutdown.
- **Enhanced monitoring:** The system provides a detailed view of all connected and disconnected battery banks in the GX device list, enabling comprehensive monitoring and diagnostics.
- **Seamless reconnection:** When a disconnected BMS is ready to connect, it will safely reconnect the battery bank without causing significant current surges.
- **Automatic integration of new battery banks:** No configuration required.

How does it work?

- If the GX device sees multiple battery banks with the same VE.Can instance, the GX treats them as BMSes all connected to the same DC bus.
- When two or more BMSes are connected, they form a "virtual" battery system that appears as an additional single device in the GX device list. The virtual battery system acts as a standard battery bank with all its functions, just like a physical battery bank. DVCC will automatically select that battery bank.
- When connecting a BMS to an already running system, the acceptable voltage difference before closing the contactor depends on the capacity of the battery banks already online; the higher the capacity, the smaller the permissible voltage difference. Only when the difference is within acceptable limits will the new battery bank be connected.
- ATC & Alternator* ATC contact status are synchronised. The synchronisation of the ATC signal stops when one of the BMSes opens its main contactor which allows the rest of the system to continue operation and charging. When the disconnected set joins the connected set again, the synchronisation of ATC is restored again.

*For new system design: the Alternator can now be connected directly to the ATC contact as the main contactor inside the Lynx BMS always adheres a 2 second delay after triggering the ATC contact to allow alternators to power down before opening the main contactor.

- If a low cell voltage event arises in one of the battery banks, the associated BMS will open its contactor to allow the rest of the system to continue operation.

6.2. Requirements and limitations

This section lists the requirements and limitations of running a battery system with multiple Lynx Smart BMSes.

Requirements:

- Each Lynx Smart BMS in the system requires at least firmware v1.11.
- A GX device with firmware 3.40 or later.

Limitations:

- Only Lynx Smart BMS units with the same current rating may be used in parallel (e.g., 500A + 500A or 1000A + 1000A, but not 500A + 1000A). Lynx Smart BMS units can be mixed with Lynx BMS NG units.

- For systems with multiple Lynx Smart BMS units connected to the same VE.Can network but not part of a parallel redundant battery bank, use the GX device and go to Settings → Services → [corresponding VE.Can port] to assign each unit a unique VE.Can instance. The GX device treats BMSes with the same VE.Can instance as part of the newly created virtual battery bank.
- The overall current limit is always the sum of the limits of the active BMSes. When a BMS disconnects due to an error, the system's total current handling capacity decreases accordingly.

6.3. Electrical connections

The BMS and Distributor connections on the Lynx Smart BMS are battery bank local and can be wired as usual.

However, there are a few particularities to consider during installation. These are as follows:

1. To ensure continuous power to the GX device, wire the AUX ports of all BMSes in parallel. This configuration ensures the GX device remains powered if one BMS goes into off mode or is turned off for maintenance. A blocking diode is required for each AUX output. For details, please see the following schematics.
2. We recommend connecting a latching push button (preferably with LED) to the respective remote on/off terminals of the BMS-es instead of the factory-installed wire loop. This allows for easy activation/deactivation of each battery bank individually. For details, please see the following schematics.
3. We also recommend installing an audible alarm, such as an external buzzer, connected to Relay 1 of the GX device. When Relay 1 is configured as an alarm relay, the buzzer will sound in the event of an alarm situation. This alarm can be acknowledged directly on the GX device, which will stop the alarm sound. Alternatively, the alarm relay can be wired to integrate with a boat's alarm system.
4. If the ATC contacts are required, connect all the ATC contacts in parallel. The BMSes follow each other's ATC state. If one BMS disables ATC, the others will do the same.
5. If the ATD contact is required, wire all the ATD contacts in parallel so that loads remain operational if at least one BMS is live.
6. If an alternator ATC was designed in, then wire all relay contacts in parallel. For new systems, the alternator can be directly connected to the ATC line together with other charging sources.

The following schematic shows two Lynx BMS NG units, each managing its own battery bank, connected in parallel. The subsequent diagram provides a detailed wiring layout, including:

- Latching push buttons with integrated LEDs
- Blocking diodes, required when AUX outputs are wired in parallel
- An audible alarm, connected to Relay 1 on the GX device

Note: Most push buttons with integrated LEDs are rated for either 12 V or 24 V drive voltage. When used in a 48 V battery bank system, an additional ballast resistor is required; see legend item 'B' in the diagram.

Important: The load-side cables from each Lynx BMS to the Lynx Distributor or busbar must be of equal length to ensure balanced current sharing between the battery banks.

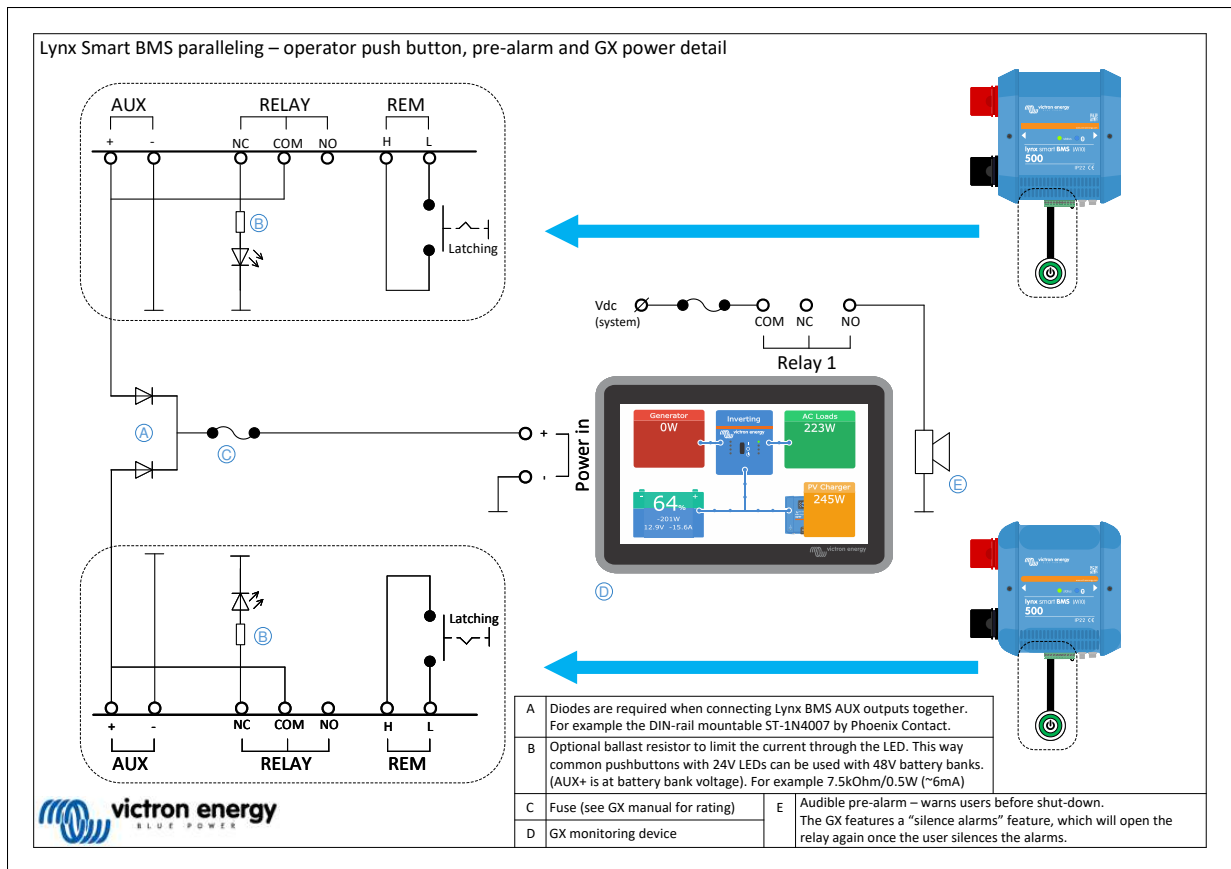
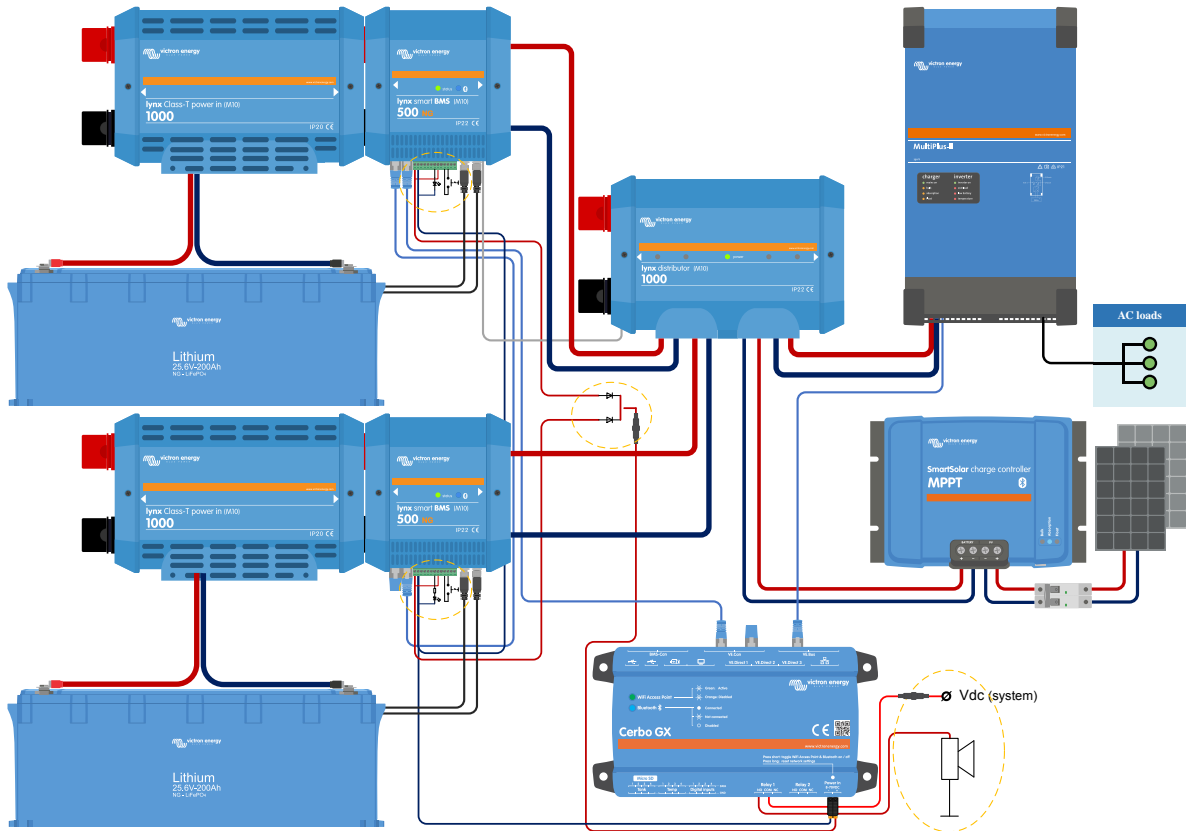

6.4. Monitoring and control

The individual BMSes are monitored and controlled like a single BMS via the GX device or VictronConnect, while the virtual BMS can only be monitored from the GX device. If the GX device has an internet connection, the parameters of the individual BMSes and the virtual BMS are also sent to the VRM portal and can be monitored there.

The virtual BMS is controlled automatically, while the individual BMSes can be controlled manually (ON, Standby, OFF).

It is also possible to assign an individual name via the Device menu.

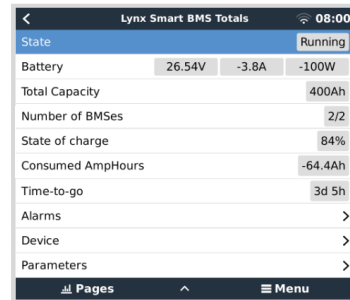

The battery monitor on VRM always displays the combined values on the VRM dashboard.

All BMS parameters are available via widgets in the VRM Advanced menu.



When a BMS powers up, it checks the voltage difference between the online battery and the newly added battery. It remains in 'Pending' state until the voltage difference is small enough to close the contactor safely. This status is displayed in the device list for the respective BMS.

When a BMS is in this state, a "system voltage" field also appears up on its device page, displaying the voltage of the parallel BMS.

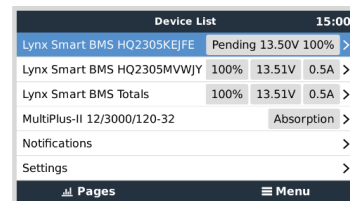

The table presents the parameters of the individual BMSes and outlines the method for calculating and displaying the combined values for the virtual BMS.

Parameter	Combined result in virtual BMS
Charge Voltage Limit (CVL)	Lowest CVL of BMSes depending on the device state (bulk, absorption and float)
Charge Current Limit (CCL)	Sum of all CCL
Discharge Current Limit (DCL)	Sum of all DCL
State of charge (SoC)	Average of SOC weighted by capacity share
Capacity (Ah)	Sum
Time to go (TTG)	Average of BMSes
Battery voltage	Average
Battery current	Sum
Battery power	Sum
Battery temperature	Maximum

6.5. Frequently Asked Questions (FAQ)

This section answers common questions and concerns to help you better understand and use the parallel BMS feature. If you're troubleshooting a problem, need clarification on features, or are looking for tips to optimise your experience, you'll find some helpful answers here. If your question isn't answered, please refer to the detailed sections of this manual.

Q: What happens when I have two banks, the first fully charged and the second empty, and I enable both BMSes simultaneously?

A: Both BMSes will start pre-charging. The empty one will complete pre-charging first and then connect. The second BMS will go into pending mode and wait for the voltage difference to be within limits; in other words, it waits for the first bank to be charged to a similar voltage.

Q: What happens when I have one bank fully charged and online and then enable the second bank, which is empty?

A: The second bank will go into standby mode and wait for the voltage difference to be within limits, i.e., for the online bank(s) to discharge to a low enough voltage.

Q: What happens the other way around, with an empty bank online and a full bank added?

A: The full bank will go into pending mode until the voltage limit is within the limit, i.e., until the empty bank is charged.

Q: What happens if there is a communication loss between BMSes?

A: It depends on where the connection is interrupted in the chain of BMSes. Let's imagine a system with two battery banks, as shown in the image below:

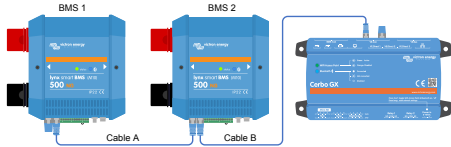
Event	Behaviour	
Cable A is disconnected or broken	<p>BMS 1: BMS issues a warning that the CAN connection is lost and continues to operate as a standalone BMS</p> <p>BMS 2: Continues to operate as a standalone BMS while maintaining communication incl. DVCC with the GX device</p> <p>Virtual BMS: Remains present on the GX device and indicates that only one of the two BMSes is connected</p>	
Cable B is disconnected or broken	<p>BMS 1: Continues to operate in parallel while communication with the GX device is interrupted</p> <p>BMS 2: Continues to operate in parallel while communication with the GX device is interrupted</p> <p>For both BMSes: DVCC is not functioning because neither BMS can communicate with the GX device. Therefore, the charging algorithm defined in the charger(s) is now in effect</p> <p>Virtual BMS: Disappears from the device list</p>	
Error in battery bank 1 or 2	<p>BMSes: The BMS will turn off the defective battery bank while the other BMSes continue to operate as standalone BMSes</p> <p>DVCC parameters (CCL, CVL and DCL) are based on the battery to BMS that is still active</p>	
Power supply failure in one BMS	<p>BMSes: The defective BMS will turn off while the other BMSes continue to operate as standalone BMSes</p> <p>DVCC parameters (CCL, CVL and DCL) are based on the battery to BMS that is still active</p>	

Q: What happens if an error occurs in one of the battery banks?

A: See the table above.

Q: What happens if a power supply fails in one of the BMSes?

A: See the table above.

Q: How does the pre-charge circuit handle the voltage difference when connecting to an already running system?

A: When connected to an already running system, the accepted voltage difference before closing the contactor depends on the detected capacity of the already online battery banks.

Q: How are the ATC and Alternator ATC contact statuses managed across multiple BMSes?

A: The synchronisation of the ATC signal stops when one of the BMSes opens its main contactor which allows the rest of the system to continue operation and charging. When the disconnected set joins the connected set again the synchronisation of ATC is restored again.

Q: What happens if a cell voltage drops too low in one of the battery banks?

A: If a cell voltage drops too low, the related BMS opens its contactor delay to prevent further discharge while the other BMSes remain online.

7. Troubleshooting and Support

Consult this chapter in case of unexpected behaviour or if you suspect a product fault.

The correct troubleshooting and support process is to first consult the common issues as described in this chapter and the [Appendix section 10.1. LED indications, warnings, alarm and error codes](#).

Should this fail to resolve the issue, contact the point of purchase for technical support. If the point of purchase is unknown, refer to the [Victron Energy Support webpage](#).

7.1. How to recover from OFF mode when no charge voltage was detected

This chapter explains how to turn on the BMS (thereby activating the system again) after the BMS has switched to OFF mode when no charge voltage has been detected for 5 minutes after a low cell voltage event or a low SoC shutdown.

Background:

If, after a low cell voltage or low SoC event, the BMS does not detect a charge voltage within 5 minutes, the BMS will enter OFF mode. In OFF mode, the ATC and ATD contacts are open, and all interfaces except Bluetooth are turned off to conserve energy. All chargers and loads turn off when the ATC and ATD contacts open. If, at a later stage, the chargers in the system are powered by the grid or a generator, they will still remain off because the BMS is not generating the ATC signal.

There are two ways to make the BMS leave the OFF state so that the system will power up:

- Connect an external charger to the system. The BMS will resume normal operation and close the contactor when it detects a charge voltage on the system side of the BMS.
- Use the Remote on/off switch or the soft switch in the VictronConnect app as described in the next paragraph.

Force the BMS out of OFF mode:

To force the BMS out of OFF mode, switch the BMS Remote on/off switch or the soft switch in the VictronConnect app off for 5 seconds and then switch it back on or unplug the 11-pin multi connector from its socket and reinsert it after 5 seconds.

The BMS will activate and close its contactor so that the battery is again connected to the system, even though the battery voltage might be too low. The BMS will close the ATC and ATD contacts, provided that the battery allows this. However, in case of an empty battery, the ATD contact will stay open, and only the ATC contact will close.

As soon as the ATC contact is closed, the system's chargers reactivate and start charging the battery.

Once the battery is sufficiently charged, the ATD contact will close, and the loads will reactivate.



Note that if no sufficient charge voltage (check the [BMS operating mode chapter](#) for charge voltages) is detected within 5 minutes, the BMS will enter OFF mode again. In this case, you will have to restart the procedure as described above. Make sure beforehand that a sufficient charge source is available.

Please also note that the above procedure is not required when DVCC-controlled chargers are present in the system. They will charge for a few minutes, or MPPT chargers will stay on regardless of whether the GX device and/or ATC status is off.

7.2. Lynx Smart BMS NG does not power up

This can be caused by one of the following reasons:

No battery supply

No LEDs are illuminated on the Lynx Smart BMS NG. Check the battery supply voltage. Check cables and fuses on the battery side. It could also be that the Lynx Smart BMS NG is in OFF mode. For more info on that, see paragraph [Powering up \[29\] \[18\]](#).

Reverse battery supply

Check the polarity of the supply voltage into the Lynx Smart BMS NG. If it is reversed, correct the polarity mistake. The unit should now power up.

No charge voltage detected for 5 minutes after a low cell voltage, low SoC or low-temperature event

Ensure that a charger is connected and switched on. The battery temperature must be at least 5 °C to be allowed to charge.

Remote on/off switched off or wire loop missing

The Remote on/off switch must be turned on, or a wire loop must be inserted between pin 10 and pin 11 of the multi-connector. Check that the multi-connector is correctly seated.

Soft Switch turned off in VictronConnect App

Switch the system to ON mode using the soft switch in the VictronConnect app.

System in Standby mode

Switch the system to ON mode using the soft switch in the VictronConnect app or a connected GX device.

Battery voltage issues

The Lynx Smart BMS NG, on the first installation, will auto-detect the battery voltage and set it to either 12V, 24V or 48V. Each set voltage has a specific battery voltage range (threshold). If the Lynx Smart BMS measures a voltage that is outside this threshold, one of these alarms will be generated:

- Probably wrong system voltage - red LED flashing 7 times every 4 seconds.
- Battery voltage not allowed - red LED flashing 14 times every 4 seconds.

To fix this, check the battery settings or check the battery voltage.

This table indicates the voltage thresholds for each system voltage:

System voltage	Voltage threshold
12V	9V - 15V
24V	16V - 30V
48V	32V - 60V

Pre-charge errors

There are two specific errors that can be generated during the pre-charge process:

- Pre-charge high current: The red LED flashes six times every four seconds, indicating that the pre-charged energy or current has been exceeded.
- Pre-charge timeout: The red LED flashes five times every four seconds, indicating that the pre-charge process has taken too long to complete.

Pre-charge faults are mostly caused by:

- A short circuit on the load output – potentially caused by a malfunctioning load or if there is a wiring issue like a short circuit.
- Loads with a too-high capacitance or too-low resistance (less than 20 Ohm) have been connected to the load output.

To fix these errors, turn off or remove some loads or chargers and rule out wiring problems or shorts.

Internal error

Contact your Victron supplier if one of the following errors are occurring:

- Internal supply error - Red LED flashing 12 times every 4 seconds
- Initialisation error - Red LED flashing 9 times every 4 seconds
- Contactor failure - Red LED flashing 10 times every 4 seconds
- Hardware error - GX device alarm calibration lost - GX device alarm

7.3. Lynx Smart BMS NG operational issues

High discharge current

A high current alarm is triggered if the current exceeds 600 A (1200 A) for longer than 5 minutes. The red LED flashes eight times every four seconds. Reduce the loads connected to the Lynx Smart BMS NG so that the current through the BMS is below 500 A (1000 A).

High charge current

A high current alarm is triggered if the current exceeds 600 A (1200 A) for longer than 5 minutes. The red LED flashes eight times every four seconds. Turn chargers off so the current through the Lynx Smart BMS NG will be below 500 A (1000 A).

Contactor (relay) issues

The Lynx Smart BMS NG has three guards to protect the contactor.

- **Overcurrent protection:** an alarm is generated when the current exceeds 600 A (1200A) for 5 minutes.
- **Contactor voltage monitoring:** an alarm is generated when the voltage over the contactor is higher than 0.5V. A high voltage indicates high resistance and high power dissipation, indicating a bad contactor.

- **Electrical/mechanical protection:** Two thermal switches are mounted on the busbar. The contactor opens, and an alarm is generated when the busbars' temperature exceeds 130 °C.

High BMS temperature

Check ambient temperature and check if the two built-in fans are running. Reduce the ambient temperature.

Settings invalid

Settings data is corrupt. Reset to factory defaults.

7.4. BMS issues

7.4.1. The BMS frequently disables the battery charger

A balanced battery will not switch off the charger even if it is fully charged. However, if the BMS switches the charger off frequently, this indicates an imbalance in the cells.

In case of moderate or large cell imbalance, it is expected behaviour that the BMS frequently disables the battery charger. This is the mechanism behind this behaviour:

As soon as one cell reaches 3.60V, the BMS disables the charger due to high cell voltage. Whilst the charger is disabled, the cell balancing process still continues, moving energy from the highest cell into adjacent cells. The highest cell voltage drops, and as soon as it falls below 3.6V, the charger is activated again. This cycling typically takes between one and three minutes. The voltage of the highest cell will rise again quickly (this can be in a matter of seconds), after which the charger will be disabled again and so forth. This does not indicate a problem with the battery or the cells and will continue with this behaviour until all cells are fully charged and balanced. This process might take several hours, depending on the level of imbalance. In case of serious imbalance, this process can take up to 12 hours. Balancing will continue throughout this process and balancing even takes place when the charger is disabled. The continued enabling and disabling of the charger can appear strange, but rest assured that there is no problem. The BMS merely protects the cells from overvoltage.

7.4.2. The BMS displays an alarm even though all cell voltages are within range

A loose or damaged BMS cable or connector is a possible cause. Check all BMS cables and their connections.

Also consider that once a cell undervoltage alarm has occurred, the cell voltage of all cells needs to be increased to 3.2V before the BMS clears the undervoltage alarm.

A way to rule out if a fault is originating from a faulty BMS or a faulty battery is to check the BMS using the following BMS test procedure:

Multiple batteries and BMS check:

- Bypass one of the batteries by disconnecting both its BMS cables.
- Connect the BMS cables of the neighbouring batteries (or battery and BMS) to each other, effectively bypassing the battery.
- Check if the BMS has cleared its alarm.
- Repeat this for the next battery if the alarm has not been cleared.
- The BMS is faulty if the alarm is still active after all batteries have been bypassed.
- If the BMS clears its alarm when a particular battery is bypassed, that particular battery is faulty.

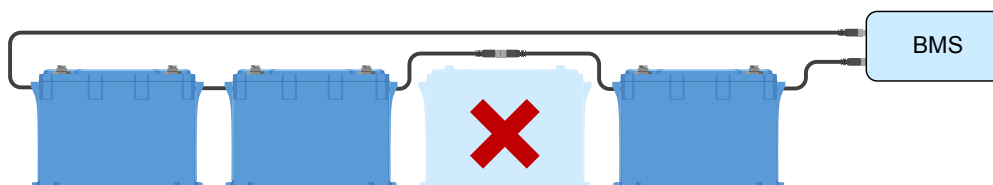

Eliminating a BMS error by bypassing a suspect battery

7.4.3. How to test if the BMS is functional

To test if the BMS is functional, disconnect one of the battery BMS cables and see if the BMS will go into alarm mode.

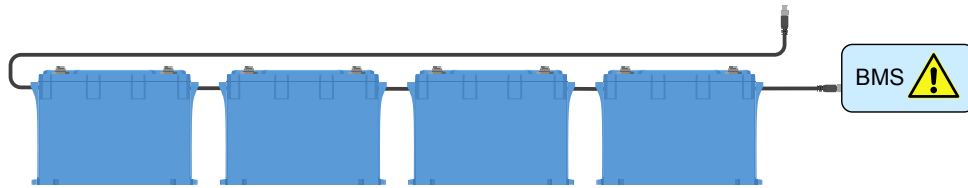

Check BMS functionality by deliberately loosening a BMS cable

7.4.4. System in OFF mode

This is indicated by the status LED off and the Bluetooth LED flashing every three seconds.

The Lynx Smart BMS NG goes into OFF mode once a low cell voltage event occurs and no charge voltage has been detected for 5 minutes to conserve as much power as possible. Bluetooth is still active, but other non-essential interfaces are turned off, including the power to the Lynx Distributor(s).

Check the cell voltages of the connected batteries, and if they are low, charge them. As soon as the Lynx Smart BMS NG sees a charge voltage, it will automatically reactivate and close its contactor to allow battery charging.

7.4.5. ATC/ATD is missing

Error #36 (ATC/ATD error) occurs when the discharge current exceeds 1.5 A while ATD is disabled, or when the charge current exceeds 1 A while ATC is disabled.

This can be caused by loads or chargers that are not properly controlled via ATC/ATD, either through the relay (hardware control) or via the CAN bus (ATC/ATD control messages).

Possible causes include:

- Loads or chargers not connected to the ATC/ATD relay outputs
- Missing or incorrect CAN bus communication (e.g. cabling issues)
- Incorrect system configuration

Ensure that all loads and chargers are correctly controlled via ATC/ATD, either by relay wiring or CAN bus communication (if not controlled by DVCC).

7.5. Battery monitor issues

7.5.1. Incomplete current reading

The negatives of all loads and charge sources in the system must be connected to the system load side of the shunt, which is the right side of the BMS in normal position.

If the negative terminal of a load or charging source is connected directly to the battery negative terminal or the "battery negative" side of the shunt, its current will not flow through the battery monitor. It will, therefore, not be taken into account, resulting in a wrong SoC reading.

7.5.2. Incorrect state of charge reading

Incorrect state of charge due to a synchronisation issue:

The synchronisation process is automatic and is performed each time the battery is fully charged. The battery monitor determines that the battery is fully charged when all 3 "charged" conditions have been met. The "charged" conditions are:

- Charged voltage (Voltage)
- Tail current (% of battery capacity)
- Charge detection time (minutes)

Practical example (default battery monitor settings and a 12.8V 200Ah Lithium NG battery) for the conditions that must be met before synchronisation takes place:

- The battery voltage has to be 14.0V (28.0V, 56.0V)
- The charge current has to be less than 0.04 x battery capacity (Ah). For a 200Ah battery this is 0.04 x 200 = 8A
- Both of the above conditions must be stable for 3 minutes

If the battery is not fully charged or if automatic synchronisation does not happen, the state of charge value will start to drift and eventually not represent the battery's actual state of charge.

The SoC can also be synchronised and set manually via the VictronConnect app.

7.5.3. Synchronisation issues

If the battery monitor does not synchronise automatically, there is a possibility that the battery will never reach a full state of charge. Fully charge the battery and check whether the charge level finally displays 100 %.

Another option is to lower the setting for the Charged voltage and/or increase the setting for the Tail current.

It is also possible that the battery monitor synchronises too early. This can happen in solar systems or systems with fluctuating charge currents. If this is the case, try to decrease the Charged voltage, Tail Current, and Charged detection time settings slightly.

7.6. VictronConnect issues

Interrupted firmware update

This is recoverable. Just try to update the firmware again.

7.7. GX device issues

This chapter only describes the most common issues. If this chapter does not solve your issue, consult the manual of the GX device.

Incorrect CAN-bus profile selected

Check that VE.Can is set to use the correct CAN-bus profile. On your GX device, navigate to Settings/Services/VE.Can port and check if it is set to "VE.Can & Lynx Ion BMS (250kbit/s)".

Also make sure that the Lynx Smart BMS NG is connected to the VE.Can port of your GX device and not the BMS-Can port (e. g. on a Cerbo GX).

RJ45 terminator or cable issue

VE.Can devices connect in "daisy chain" to each other and a [RJ45 terminator](#) needs to be used with the first and last device in the chain.

When connecting VE.Can devices, always use "manufactured" [RJ45 UTP cables](#). Do not manufacture these cables yourself. Faulty homemade cables cause many communication and other seemingly unrelated product issues.

8. Technical specifications

Power	Lynx Smart BMS NG 500A	Lynx Smart BMS NG 1000A
Supply voltage range	9 – 60 Vdc	
Supported system voltages	12, 24 or 48 V	
Reverse polarity protection	No	
Main safety contactor continuous current rating	500 A continuous	1000 A continuous
Main safety contactor peak current rating	600 A for 5 minutes	1200 A for 5 minutes
Power consumption OFF mode	0.3 mA for all system voltages	
Power consumption in Standby mode	Approximately 0.6 W (50 mA at 12 V)	
Power consumption in ON mode	Approximately 2.6 W (217 mA at 12 V), depending on the state of the relays	Approximately 4.2 W (350 mA at 12 V), depending on the state of the relays
Minimum load resistance for pre-charging	10 Ω and above for 12 V systems 20 Ω and above for 24 V and 48 V systems	
AUX output maximum current rating	1.1 A continuous, protected by a resettable fuse	
Allow-to-charge port maximum current rating	0.5 A at 60 Vdc, protected by a resettable fuse	
Allow-to-discharge port maximum current rating	0.5 A at 60 Vdc, protected by a resettable fuse	
Programmable relay (SPDT) maximum current rating	2 A at 60 Vdc	

Connections	Lynx Smart BMS NG 500A	Lynx Smart BMS NG 1000A
Busbar and torque	M10 (Torque: 33 Nm)	
VE.Can	RJ45 and RJ45 terminator	
I/O	Removable 13-pin multi-connector with screw terminals	
Battery BMS cables	Male and female circular 3-pole connector with M8 screw ring Up to 50 batteries can be connected to the BMS by daisy chaining them	
Lynx Distributor (up to 4 modules)	RJ10 (cable ships with each Lynx Distributor)	

Physical	Lynx Smart BMS NG 500A	Lynx Smart BMS NG 1000A
Enclosure material	ABS	
Enclosure dimensions (h x w x d)	190 x 180 x 80 mm	230 x 180 x 100 mm
Unit weight	1.9 kg	2.7 kg
Busbar material	Tinned copper	
Busbar dimensions (h x w)	8 x 30 mm	

Environmental	Lynx Smart BMS NG 500A	Lynx Smart BMS NG 1000A
Operating temperature range	-40 °C to +60 °C	
Storage temperature range	-40 °C to +60 °C	
Humidity	Max. 95 % (non-condensing)	
Protection class	IP22	

Standards	Lynx Smart BMS NG 500A	Lynx Smart BMS NG 1000A
Safety	EN-IEC 63000:2018	
EMC	EN-IEC 61000-6-3:2007/A1:2011/AC:2012	
QMS	NEN-EN-ISO 9001:2015	

9. Appendix

9.1. LED indications, warning, alarm and error codes

LEDs

The Lynx Smart BMS NG is equipped with two LEDs, the Bluetooth LED and the Status LED. These LEDs will indicate the operation mode and the fault mode in case there is a fault.

Bluetooth LED	Description
Off	No system power or Bluetooth is disabled in the VictronConnect app. Bluetooth can be disabled in both VictronConnect and a GX device but only enabled from a GX device.
Blue on	A Bluetooth device is connected to the Lynx Smart BMS NG
Blue flashing	Bluetooth is active, but no device is connected
Blue flashing at 3 seconds interval	The Lynx Smart BMS NG is in OFF mode but is still accessible via Bluetooth

Status LED	Description
Off	The Lynx Smart BMS NG is in OFF mode
Orange on	Initialising or shutdown
Orange blinking	Delayed shutdown due to cooling down the pre-charge circuit
Green on	Running, the contactor is closed
Green blinking	Pre-charging
Green flashing at 3 seconds interval	The Lynx Smart BMS NG is in Standby mode
Green and red alternating	System in bootloader mode (updating firmware)
Red flashing 1 time every 4 seconds	Warning, see VictronConnect for more information
Red flashing 2 times every 4 seconds	Battery communication error, check battery BMS cables
Red flashing 3 times every 4 seconds	High/low cell voltage or high/low temperature detected
Red flashing 4 times every 4 seconds	High BMS temperature detected
Red flashing 5 times every 4 seconds	Pre-charge time out
Red flashing 6 times every 4 seconds	Pre-charge high current
Red flashing 7 times every 4 seconds	Probably wrong system voltage
Red flashing 8 times every 4 seconds	Contactor current too high
Red flashing 9 times every 4 seconds	Initialisation error
Red flashing 10 times every 4 seconds	Safety contactor failure
Red flashing 12 times every 4 seconds	Internal supply error
Red flashing 14 times every 4 seconds	Battery voltage not allowed

Warning, alarm and error codes

- Warning, alarm and error codes are also reported via the VictronConnect app or a connected GX device and VRM.
- A warning indicates a problem that, if not corrected, will result in a system shutdown, while an alarm indicates the reason for the system shutdown.

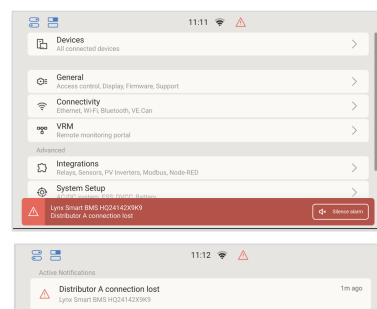
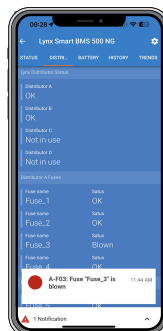

The following tables list all warning, alarm and error codes:

Warnings: Warnings indicate an issue that when unresolved will lead to a system shutdown.

VictronConnect warning code	Message	Instructions / Remarks
W-B01	Low cell voltage	Charge the battery or reduce the load to prevent an imminent system shutdown.
W-B02	High current	Reduce the current to prevent an imminent system shutdown. Do this by reducing the load or by turning loads off.
W-B03	High BMS temperature	Check the ambient temperature and check if the BMS fans are running. If the fans are running, reduce the ambient temperature. If the fans are not running, contact your Victron dealer.
W-B04	Warning bad contactor	Reduce the current to prevent an imminent system shutdown. Do this by reducing the load or by turning loads off. Contact your Victron dealer.
W-B05	BMS cable fault	Check the cable between BMS and battery.
W-B06	Load will disconnect	The loads will be turned off if fault condition is not resolved. For example low battery voltage. This warning is always in combined the reason why the load will disconnect. The loads are turned off via the ATD contact and/or via the GX device.
W-B07	Low SoC	Charge battery or reduce load to prevent imminent system shutdown.
W-B10	VE.Can disconnected	Check communication cabling.
W-B11	Firmware update failure	Battery firmware update issue.
W-D01	Communication with distributor A lost	Check the cable between BMS and Distributor.
W-D02	Communication with distributor B lost	Check the cable between BMS and Distributor.
W-D03	Communication with distributor C lost	Check the cable between BMS and Distributor.
W-D04	Communication with distributor D lost	Check the cable between BMS and Distributor.
W-D05	Communication with distributor E lost	Check the cable between BMS and Distributor.
W-D06	Communication with distributor F lost	Check the cable between BMS and Distributor.
W-D07	Communication with distributor G lost	Check the cable between BMS and Distributor.
W-D08	Communication with distributor H lost	Check the cable between BMS and Distributor.

Alarms: Alarms indicate the reason why the system is shutdown

VictronConnect alarm code	Message	Instructions / Remarks
A-B01	Low cell voltage	Charge battery. The system will turn the loads back on when the battery is sufficiently charged.
A-B02	High current	Reduce charging current or turn off some loads. The system will try to re-enable chargers or loads in 5 minutes.
A-B05	BMS cable fault	Check the cable between BMS and battery.
A-B06	Load disconnected	The loads have been turned off via ATD. Resolve this alarm by charging the battery.

VictronConnect alarm code	Message	Instructions / Remarks
A-B07	Low SoC	Charge battery. The system will turn the loads back on when the battery is sufficiently charged.
A-B09	High battery temperature	The battery temperature is too high for charging. Try to reduce the ambient temperature.

Error codes

VictronConnect error code	Message	Instructions / Remarks
E-B01	Battery init failure	1) Check 'Battery' tab for more details. 2) Check if battery BMS cables are connected correctly.
E-B02	No battery found	1) Check 'Battery' tab for more details. 2) Check if battery BMS cables are connected correctly.
E-B05	Invalid number of batteries	Check that all batteries are properly connected.
E-B09	Battery voltage not allowed	The battery voltage is too high or too low. Check the battery voltage and check the battery settings in the VictronConnect app. This error occurs when the battery voltage is outside all system voltage ranges (9V > Vbat > 60V)
E-B11	Hardware error	Contact your Victron dealer.
E-B25	Pre-charge error	The load resistance is too low to pre-charge the loads. Disconnect or reduce some DC loads.
E-B26	Contact error	Contact your Victron dealer.
E-B32	BMS cable error	Check the battery M8 cabling.
E-B34	Wrong system voltage	1) Check battery voltage settings in the VictronConnect app. 2) Check if battery BMS cables are connected correctly.
E-B35	Pre-charge timeout	The load capacity is too high to pre-charge. Disconnect some DC loads.
E-B36	ATC/ATD failure	1) Check ATC/ATD wiring and CAN bus communication, and ensure all loads and chargers are controlled via ATC/ATD. 2) After resolving the issue, switch the product off and on again.
E-B116	Calibration data lost	Contact your Victron dealer.
E-B119	Settings data lost	Settings data is corrupt. Go to the settings page and reset to defaults.

Alarm codes Lynx Distributor related

VictronConnect alarm code	Message	Instruction / remarks
A-F01	Fuse "Fuse_1" is blown	Check your system and replace fuse.
A-F02	Fuse "Fuse_2" is blown	
A-F03	Fuse "Fuse_3" is blown	
A-F04	Fuse "Fuse_4" is blown	
A-F05	Fuse "Fuse_5" is blown	
A-F06	Fuse "Fuse_6" is blown	
A-F07	Fuse "Fuse_7" is blown	
A-F08	Fuse "Fuse_8" is blown	
A-F09	Fuse "Fuse_9" is blown	

VictronConnect alarm code	Message	Instruction / remarks
A-F10	Fuse "Fuse_10" is blown	
A-F11	Fuse "Fuse_11" is blown	
A-F12	Fuse "Fuse_12" is blown	
A-F13	Fuse "Fuse_13" is blown	
A-F14	Fuse "Fuse_14" is blown	
A-F15	Fuse "Fuse_15" is blown	
A-F16	Fuse "Fuse_16" is blown	
A-F17	Fuse "Fuse_17" is blown	
A-F18	Fuse "Fuse_18" is blown	
A-F19	Fuse "Fuse_19" is blown	
A-F20	Fuse "Fuse_20" is blown	
A-F21	Fuse "Fuse_21" is blown	
A-F22	Fuse "Fuse_22" is blown	
A-F23	Fuse "Fuse_23" is blown	
A-F24	Fuse "Fuse_24" is blown	
A-F25	Fuse "Fuse_25" is blown	
A-F26	Fuse "Fuse_26" is blown	
A-F27	Fuse "Fuse_27" is blown	
A-F28	Fuse "Fuse_28" is blown	
A-F29	Fuse "Fuse_29" is blown	
A-F30	Fuse "Fuse_30" is blown	
A-F31	Fuse "Fuse_31" is blown	
A-F32	Fuse "Fuse_32" is blown	

* If the fuse name is not set, the default name is used. If it is set, the name configured in VictronConnect for the Lynx Distributor is used.

9.2. Supported NMEA 2000 PGNs

Description	PGN
Product Information	126996
DC detailed Status	127506
DC/Battery Status	127508
Switch Bank Status <ul style="list-style-type: none"> • Status 1: Contactor • Status 2: Alarm • Status 3: Battery voltage low • Status 4: Battery voltage high • Status 5: Programmable relay status 	127501

Class and function:

- N2K device class: Electrical generation
- N2K device function: Battery

For more information see the [NMEA2000 & MFD integration guide](#).

9.3. List of battery monitor settings

Description	default value	adjustable	fixed	automatic
Battery capacity	---	No	No	Yes
Charged voltage	14.0V/28.0V/56.0V*	Yes	No	No
Tail current	4%	Yes	No	No
Zero current calibration	---	No	No	Yes (at power up)
Peukert exponent	1.05	No	Yes	No
Charge efficiency factor	99%	No	Yes	No
Current threshold	0.05A	No	Yes	No
Low SoC warning level	15%	Yes	No	No
Discharge floor	10%	Yes	No	No
Delta T	1	No	Yes	No
SoC Cycle end	90%	No	Yes	No
SoC Cycle	65%	No	Yes	No
SoC full discharge	5%	No	Yes	No

* for a 12V/24V/48V system

9.4. Multi-connector pin-out and overview

Pin	Name	Type	Function
1	AUX voltage output +	System voltage positive	The positive connection to power auxiliary devices, like a GX device.
2	AUX voltage output -	System voltage negative	The negative (ground) connection to power auxiliary devices, like a GX device.
3 4	Allow to charge	Potential free contact	Turns chargers on or off via a wired signal. Pin 3 can be used as the signal input for pin 4 and wired e. g. from AUX + or AUX -. See system examples for correct wiring. When charging is allowed, the contacts are closed and when not allowed, the contacts are open.
5 6	Allow to discharge	Potential free contact	Turns loads on or off via a wired signal. Pin 5 can be used as the signal input for pin 6 and wired, e. g. from AUX + or AUX -. See system examples for correct wiring. When discharging is allowed, the contacts are closed and when not allowed, the contacts are open.
7	Programmable relay NC	Potential free contact	The programmable relay is used to either control an alternator or as an alarm relay. For details, see chapter Programmable relay wiring .
8	Programmable relay COM	Potential free contact	
9	Programmable relay NO	Potential free contact	
10	Remote on/off H	Pull-up resistor	To remotely turn the Lynx Smart BMS on or off. For full functionality, see chapter Wiring the Remote on/off .
11	Remote on/off L	Pull-down resistor	
12		Sensor	Not supported yet, future use
13		Sensor	Not supported yet, future use

9.5. Lynx Smart BMS NG-related menu structure of the GX device

This is an overview of the GX device's Lynx Smart BMS NG-related menu structure.

Menu item	Default value / unit	Description and / or possible values
Lynx Smart BMS NG	Shows the most important battery parameters at a glance	
Switch	On	Soft switch to manually switch the Lynx Smart BMS NG to Standby or On mode
State	Running	Possible states: Initialising, Pre-charging, Running, Shutdown, Standby
Error	#0 - No error	Error state
Battery bank error	None	
Battery	Voltage, current, power	Shows current battery monitor data
State of charge	%	State of charge in percent
Battery temperature	°C	The current battery temperature
Consumed AmpHours	Ah	Displays the consumed AH since the battery was last fully charged
Time-to-go	Days / Hours	Displays the estimated time based on the current load and discharge floor setting
Details	Provides information at cell level	
Lowest cell voltage	V	The currently lowest cell voltage
Highest cell voltage	V	The currently highest cell voltage
Minimum cell temperature	°C	The currently lowest cell temperature
Maximum cell temperature	°C	The currently highest cell temperature
Alarms	Overview of the alarm status	
High internal temperature	Ok	
Low cell voltage	Ok	
Low SoC	Ok	
Low cell voltage	Ok	
Module level alarms	Overview of module-level alarms	
History	The history data since the last reset	
Deepest discharge	Ah	The deepest discharge since last history reset
Total charge cycles	0	Number of charge cycles since last history reset
Number of full discharges	0	A full discharge is accounted for after SoC falls below 5%
Cumulative Ah drawn	Ah	Cumulative Ah drawn since last history reset
Minimum voltage	V	Minimum voltage since last history reset
Maximum voltage	V	Maximum voltage since last history reset
Minimum cell voltage	V	Minimum cell voltage since last history reset
Maximum cell voltage	V	Maximum cell voltage since last history reset
Time since last full charge	Days / Hours	
Synchronisation count	0	Cumulative number of battery monitor synchronisations
Minimum temperature	°C	Minimum battery temperature since last history reset
Discharged energy	kWh	Cumulative number of discharged energy since last history reset
Charged energy	kWh	Cumulative number of charged energy since last history reset
Clear history	Press to clear	Clears all history data
Settings	Generic settings	
Restore factory defaults		Press to restore factory defaults
Bluetooth enabled	Yes	Toggle Bluetooth on/off
Battery bank		

Menu item	Default value / unit	Description and / or possible values
Nominal voltage	V	Nominal battery bank voltage
Capacity	Ah	Nominal battery bank capacity
Diagnostics		
Diagnostics		Shows last known errors
Fuses		
Distributor [A..H]	Ok	Possible states: Ok, Fuse blown
Fuse 1..4	Ok	Possible states: Ok, Not used, Blown
IO		
System switch	Enabled	Status of the system switch
Allow to charge	Yes	Status of the ATC signal
Allow to discharge	Yes	Status of the ATD signal
System		
Capacity	Ah	Total battery capacity
Batteries	1	Number of batteries
Parallel	1	Number of batteries in parallel
Series	1	Number of batteries in series
Min/max cell voltage	V	The currently lowest and highest cell voltage
Min/max cell temperature	°C	The currently lowest and highest cell temperature
Balancer status	Balanced	The status of the balancer
Device	Device-related parameters and custom name setting	
Parameters		
Charge Voltage Limit (CVL)	V	Shows the voltage target sent to DVCC-compatible chargers (for a 12V battery: 13.50V or 14.20V)
Charge Current Limit (CCL)	A	Maximum allowed charge current limit sent to DVCC-compatible chargers
Discharge Current Limit (DCL)	A	Maximum allowed discharge current limit

9.6. Reversed power distribution



WARNING: ELECTRICAL SHOCK AND FIRE HAZARD

Disable and remove all voltage sources before opening the enclosure or performing any service operations. Use a voltmeter to ensure that there is no residual voltage from internal capacitors, batteries or the like. Failure to observe this instruction may result in burns or fire.

9.6.1. Introduction

This guide describes how to configure the Lynx Smart BMS and Lynx Smart BMS NG for reversed power distribution.

By default, power flows from left to right: DC power sources connect to the left-hand side, and DC loads to the right. This guide is intended for cases where this arrangement needs to be reversed. It applies to all models and hardware revisions of the Lynx Smart BMS.

9.6.2. Models and variants

There are currently two models and two variants of the Lynx Smart BMS.

The models differ by current rating:

- 500 A version with one power contactor
- 1000 A version with two power contactors

The variants are distinguished by enclosure marking:

- NG (New Generation)
- Non-NG (original design)

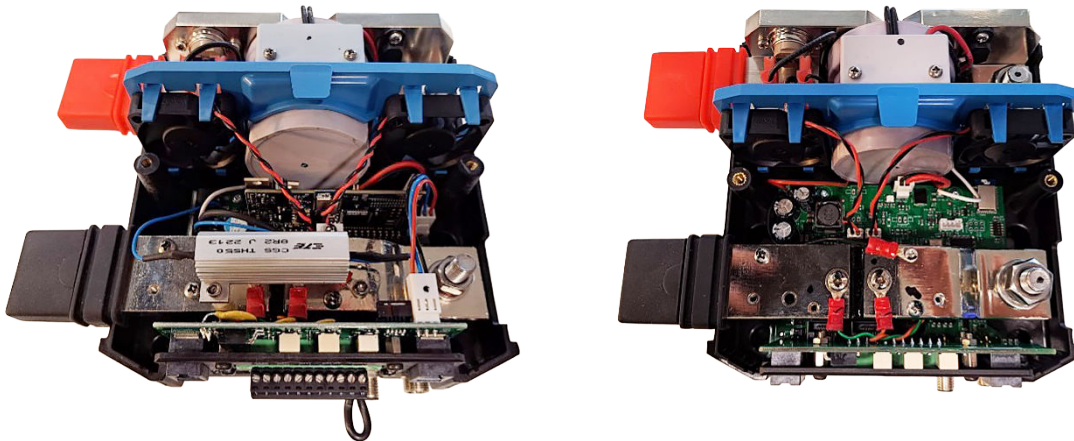

9.6.3. Technical background

The primary function of the Lynx Smart BMS is to monitor system and battery voltages, as well as the currents flowing through the device, thereby protecting the battery from under- and overcharging.

Before closing the main power contactor, the BMS performs a short-circuit check on the load side by pre-charging any connected loads. It also monitors the current through the busbar's shunt to prevent over-current situations that could damage cables or the battery.

Reversing the power distribution requires specific configuration changes, as the load and source connections - and the current flow through the shunt - are reversed. The current shunt is a low-ohmic resistor, precisely factory-calibrated. User modifications to the shunt are not permitted, as even minor changes can introduce contact resistance and invalidate the calibration.

To compensate for the reversed current flow, a dedicated software setting is available. This must be configured via Bluetooth using the VictronConnect app, available from the Victron Energy website.



Without these modifications, the Lynx Smart BMS will not function as intended.

9.6.4. Wiring adjustment procedure

This procedure involves relocating the voltage sense wires on either side of the power contactor:

Voltage sense wires involved:

- Red wire = Source voltage
- White wire = Load voltage

Steps

1. Access the wiring area
 - Remove the fan bracket from its holder and set it aside
Do not disconnect the fan cables; the connector has limited mating cycles.

2. Swap the wires
 - Move the white wire to the left side



For the Lynx BMS 1000A: On units with serial numbers before HQ2530, the white wire may be too short and will need to be extended.

- Move the red wire to the right side
- Use a 2.5 mm Allen key to loosen the screws, reposition the wires, and re-tighten them.
3. Secure the wiring
 - Ensure screws are snug, but do not overtighten.

- Route the wires neatly along the bottom corner of the power contactor to avoid obstructing the fan bracket.
 - Refit the fan bracket.
4. Check clearance
 - Ensure the now-crossed wires do not block the internal light pipes.
 5. Close the unit
 - Refit the enclosure cover and tighten all screws before applying power.

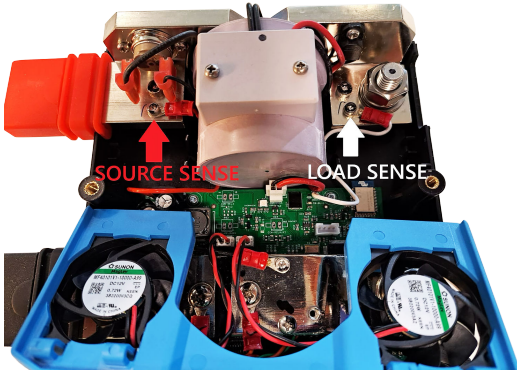

Source and load voltage sense

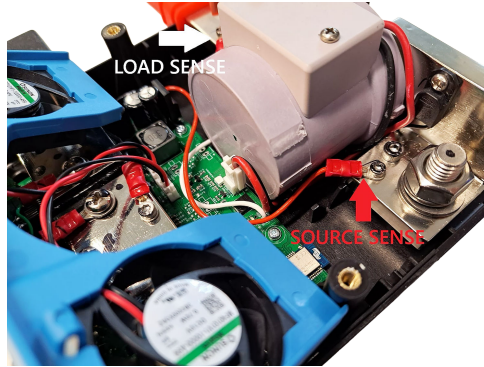

Swapped wires for reversed power distribution

9.6.5. Configuring the reversed current setting

Follow these steps after completing the voltage sense wire swap:

1. Open the VictronConnect app
2. Select your Lynx Smart BMS from the device list
3. Tap the cogwheel icon in the top-right corner
4. Select Current measurement direction
5. Set it to Reversed

 Without applying both the wiring and software modifications, the Lynx Smart BMS will not function as intended.

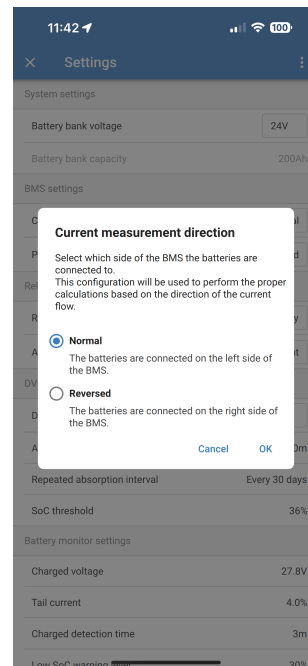

Reverse current setting in VictronConnect

9.6.6. Final check

Before leaving the installation unattended:

- Power on the unit and properly test and verify the unit's functionality
- Confirm correct operation
- Ensure all protective functions are active

If you are not confident in performing the procedure, contact your local Victron representative for assistance.

9.7. Enclosure dimensions

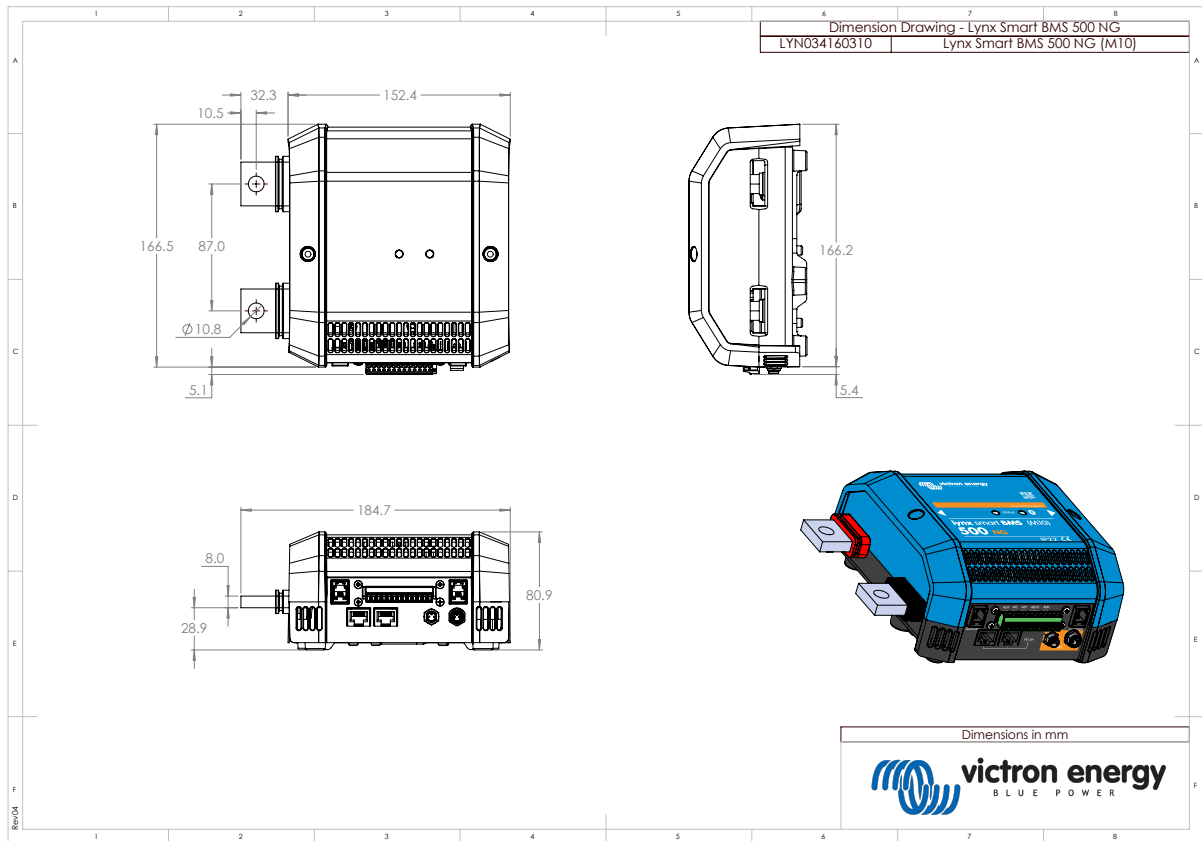

Lynx Smart BMS NG 500A (M10) model enclosure dimensions

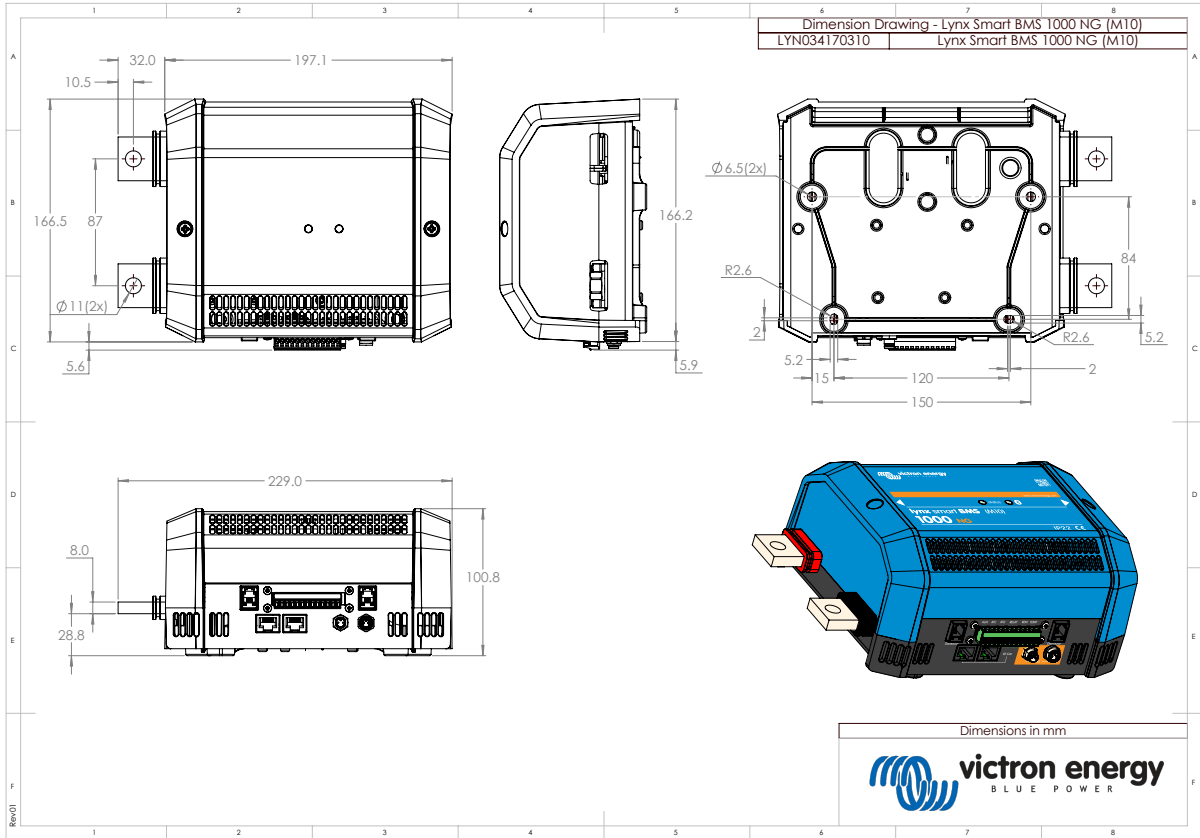

Lynx Smart BMS NG 1000A (M10) model enclosure dimensions