

Battery system home storage series

User Manual



ProductName: 48V100Ah Lithium Battery

ProductModel: SG48100P

ProductSpecifications: 51.2V 100Ah

CompilationDate: 2022-12-12

Catalogue

1. Document description	3
2. Definition of Terms	3
3. Battery system performance parameters	3
4. Outline and Structural Dimensions of Battery System	5
5. Definition of battery system interface	6
5.1. Panel Schematic	6
5.2. Module Panel Description	6
6. Functional block diagram	7
7. Battery Management System Specifications	7
7.1. Basic parameter settings	7
7.2. Interface	10
7.2.1. Interface diagram	10
7.2.2. Interface Definition	11
7.3. Communication description	12
7.3.1. RS232 communication	12
7.3.2. RS485 communication	12
7.3.3. CAN communication	12
8. Product function and performance description	13
8.1. Charging performance	13
8.2. Discharging performance	13
9. Using & Maintenance Suggestions	14
9.1. LED indication description	14
9.2. Buzzer action description	15
9.3. Key Description	15
9.4. Sleep and wake up	16
9.4.1. hibernate	16
9.4.2. wake	16
9.5. DIP switch settings	17
9.6. The routine maintenance of the battery part can be carried out by referring to the table	18
10. Packing List	18
11. Storage, maintenance and transportation	19
11.1. Storage	19
11.2. Transportation	19
12. Maintain	19
13. Battery usage precautions	19
14. Product Liability	20

1. Document description

This specification covers the performance indexes, technical requirements and safety issue of the 48V100Ah

2. Definition of Terms

BMS	Battery Management System
DOD	Depth Of Discharge
EOL	End Of Life
OCV	Open Circuit Voltage
SOC	State Of Charge
SOH	State Of Health
EMC	Electro Magnetic Compatibility
Nominal voltage	Appropriate voltage approximation to identify or identify a cell or an electrochemical system.
Capacity	(The amount of power a battery can provide when fully charged under specified conditions. Usually expressed in Ah.)
Energy	The energy that can be provided by a fully charged battery under specified conditions. Usually expressed in Wh or kWh.
Unit	“V” (Volt) (Voltage unit) “A” (Ampere) (Current unit) “Ah” (Ampere-Hour) (unit of charge) “Wh” (Watt-Hour) (electrical energy unit) “Ω” (Ohm) (resistance unit) “ °C” (degree Celsius) (temperature unit) “mm” (millimetre) (length unit) “s” (second) (Time unit) “kg” (kilogram) (Weight unit) “Hz” (Hertz) (Frequency unit)

3. Battery system performance parameters

No.	Item	Technical parameter	Note
1	Battery Type	Lithium iron phosphate battery	/
2	Rated capacity	100Ah	@25°C±2, 0.5C, 100%DOD
3	Nominal voltage	51.2V	
4	Recommended charging voltage	54.5V	
5	Charging Limited Voltage	42V	
6	SOC working range	0~100%	Recommended range of use: 20%~95%
7	Standard discharge current	50A	

8	Maximum continuous discharge current	100A	
9	Standard charging current	50A	
10	Maximum continuous charge current	100A	
11	Maximum cut-off voltage for charging	57.6V	
12	Charge cut-off current	5A	0.05C magnification
13	Discharge cut-off voltage	43.2V	
14	PACK cycle life	≥7000	80%DOD 25°C±2°C, 0.5C charge/0.5C discharge
15	Thermal management method	Natural heat dissipation	
16	IP protection class	IP31 battery box	
17	Flammability rating	plastic parts UL94 V-0	
18	Total system mass	Around 43KG	
19	Battery system shell material	BLACK Q235A	Color can be customized
20	Shipping SOC	SOC45-55%	
21	Dimension (L*W*H mm)	☑442*460*133 (3U) ±1mm	
22	Design life	15 Year	
23	Parallel function	Supports up to 16 batteries in parallel	
24	Anti-theft function	sensor G-sensor anti-theft function	
25	Display function	English smart display	
26	Charging current limit function	Current limit 20A	Charging current limit can be set according to customer requirements
27	Communication mode	☑RS232	Communication mode can be set according to customer requirements
		☑RS485	
		☑CAN	
28	communication protocol	Support multiple protocols	Communication protocol can be set according to customer requirements
29	Storage ambient temperature	-10~+45°C	Recommended storage temperature: 0~+30°C
30	Working temperature	Battery charging:0~45°C Battery discharging:-20~ +60°C	
31	Relative humidity of working environment	≤95	Best Use Relative Humidity: ≤85%

4. Outline and Structural Dimensions of Battery System

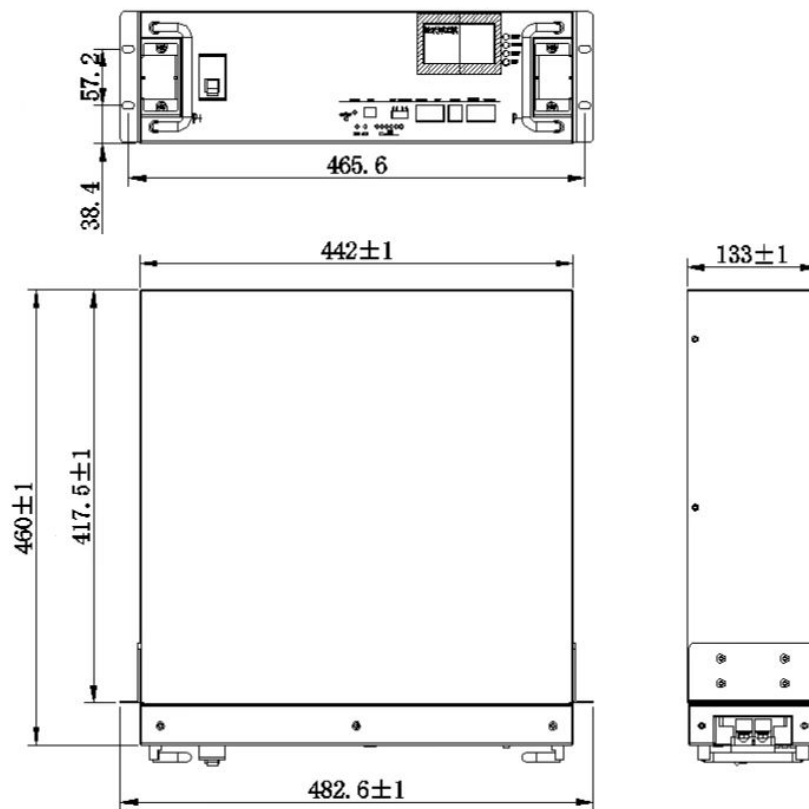

5. Definition of battery system interface

5.1. Panel Schematic

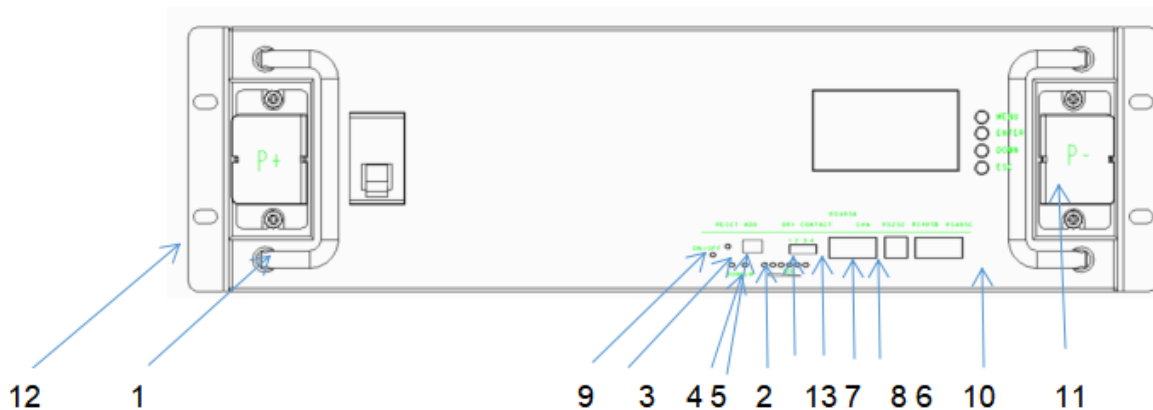

5.2. Module Panel Description

NO	Function definition	Function Description	Note
1	handle	Carrying handle	
2	SOC	Capacity status light	Six green LED lights to show the current charge of the lithium battery pack
3	ALM	Alert	Red LED light, normally off under normal conditions, always on under fault conditions, and a voice prompt
4	RUN	Run	Green light, always on when the product is running
5	ADD	DIP switch	Use 4 bit binary DIP switch (optional) to set address allocation when products are used in parallel,
6	RS232	RS232 communication	Uplink communication port, RS232 communication mode when uploading data, data content includes system parameters, system status and alarm information. The rate of 9600bps is generally used. Note: Wiring definitions are implemented in accordance with BMS product specifications
7	RS485	RS485 communication	RS485 communication method
8	CAN	CAN communic	CANcommunication method
9	RESET	Reset	When the product is in an abnormal state or in a hibernation state, the product can be restarted and woken up through the reset button to ensure the stable operation of the system
10	Main panel	Shell	Sheet metal thickness 1.5mm, galvanized frosted paint, color: black
11	Terminals	Input and output terminals	Battery positive and negative output terminals
12	Hanging ears	Mounting ears	The spacing is implemented according to the national standard
13	dry contact terminal	Load output port	example: definition: Dry contact 1-PIN1 to PIN2: normally open, closed during fault protection Dry contacts 2-PIN3 to PIN4: normally open, SOC<5%, closed for low battery alarm.

6. Functional block diagram

The functional block diagram is shown in the figure below

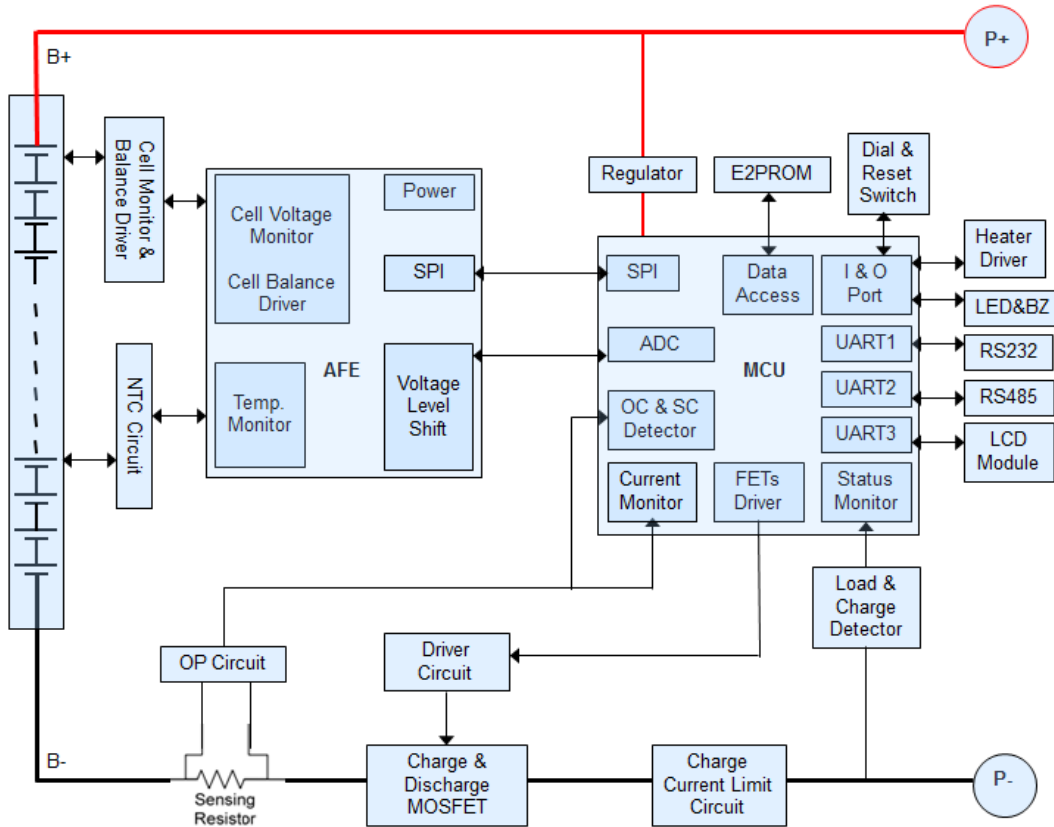

7. Battery Management System Specifications

7.1. Basic parameter settings

NO.	Indicator item		Factory default parameters	Is it possible to set	Note
1	Cell overcharge protection	Cell overcharge alarm voltage	3600mV	Can be set	
		Cell overcharge protection voltage	3650mV	Can be set	
		Cell overcharge protection delay	4.0S	Can be set	
	Single Overvoltage Protection Released	overcharge protection release voltage Cell	3380mV	Can be set	
		Capacity release	SOC < 96%	Can be set	
		Discharge release	> 1A		
2	Cell overdischarge protection	Cell over-discharge alarm voltage()	2700mV	Can be set	After 30 seconds of over-discharge protection, if it still cannot recover, it will enter low
		Cell over-discharge protection voltage	2500mV	Can be set	
		Monomer over-discharge protection delay	1.0S	Can be set	
	Cell over-discharge	Cell over-discharge protection release voltage	2800mV	Can be set	

	protection released	(Release when charging)	Plug into the charger to activate		power consumption mode
3	Overall overcharge protection	Overall overcharge warning voltage	57.6V	Can be set	
		Overall overcharge protection voltage	58.4V	Can be set	
		Overall overcharge protection delay	1.0S	Can be set	
	Overall overvoltage protection released	Overall overcharge protection release voltage	54.1V	Can be set	
		Capacity release	SOC<96%	Can be set	
		Discharge release	> 1A Discharge current > 1A		
4	Overall overdischarge protection	Overall over-discharge warning voltage	43.2V	Can be set	After 30 seconds of over-discharge protection, if it still cannot recover, it will enter low power consumption mode
		Overall over-discharge protection voltage	40V	Can be set	
		Overall over-discharge protection delay	1.0S	Can be set	
	Overall over-discharge protection released	Overall over-discharge protection release voltage	44.8V	Can be set	
		Release when charging	Plug into the charger to activate		
	Charging current limit function	Charging current limit	20A		
5	Charge overcurrent protection	Charge overcurrent 1 alarm current	105A	Can be set	Appearing 10 times in a row will lock the status and will no longer automatically release
		Charge overcurrent 1 protection current	110A	Can be set	
		Charge overcurrent 1 protection delay	1.0S	Can be set	
	Charging overcurrent 1 protection released	Automatic release)	1min Automatically cancel after 1min		
		Discharge release	> 1A Discharge current > 1A		
6	Discharge overcurrent 1 protection	Discharge overcurrent 1 alarm current)	105A	Can be set	Appearing 10 times in a row will lock the status and will no longer automatically release
		Discharge overcurrent 1 protection current)	110A	Can be set	
		Discharge overcurrent 1 protection delay	1.0S	Can be set	
	Discharge overcurrent 1 protection released	Automatic release	1min Automatically cancel after 1min		
		Charge release	> 1A Charge current > 1A		
7	Discharge overcurrent 2	Discharge overcurrent 2 protection current	≥120A	Can be set	Appearing 10 times in a row will lock the status and will no longer automatically
		Discharge overcurrent 2 protection delay	100mS	Can be set	
	Discharge	Automatic release	1min		

	overcurrent 2 protection released		Automatically cancel after 1min	release
		charge release	> 1A Charge current > 1A	
8	Short circuit protection	Short circuit protection function	(Have)	
		Short circuit protection current	$\geq 350A$	
		Short circuit protection delay	$\leq 300US$	
		Short circuit protection released	When there is charging, the short circuit protection is released After the load is removed, it will automatically disarm	
9	MOS high temperature protection	MOS over temperature alarm temperature)	90°C	Can be set
		MOS over temperature protection temperature)	115°C	Can be set
		MOS protection release temperature)	85°C	Can be set
10	Cell temperature protection	Charging low temperature warning temperature)	0°C	Can be set
		Charging low temperature protection temperature)	-5°C	Can be set
		Charging low temperature protection release temperature	0°C	Can be set
		Charging high temperature alarm temperature	50°C	Can be set
		Charging high temperature protection temperature)	55°C	Can be set
		Charging high temperature protection release temperature	50°C	Can be set
		Discharge low temperature alarm temperature	-15°C	Can be set
		Discharge low temperature protection temperature	-20°C	Can be set
		(Discharge low temperature protection release temperature	-15°C	Can be set
		Discharge high temperature alarm temperature	60°C	Can be set
		Discharge high temperature protection temperature	65°C	Can be set
Discharge high temperature protection release temperature	55°C	Can be set		
11	Ambient temperature alarm	Ambient low temperature alarm temperature	-15°C	Can be set
		Ambient low temperature protection temperature	-20°C	Can be set
		Ambient cryogenic protection release temperature	-15°C	Can be set
		Ambient high temperature alarm temperature	65°C	Can be set
		Ambient high temperature protection temperature	75°C	Can be set
		Ambient high temperature protection release	65°C	Can be set

		temperature			
12	Current consumption	Self-consumption current during operation	$\leq 45\text{mA}$ ((with display)		
			$\leq 40\text{mA}$ (without display)		
		Low power mode current	$\leq 200\mu\text{A}$		
13	Equalization function	Equalization turn-on voltage	3500mV	Can be set	
		Open differential pressure	30mV	Can be set	
14	Capacity default settings	Low battery warning	SOC<5%	Can be set	(No alarm when charging)
		Full capacity setting	100AH	Can be set	
15	Sleep function	Sleep voltage	3150mV	Can be set	
		Delay	5min	Can be set	
16	Differential pressure alarm	Overpressure alarm	800mV		
		Overpressure recovery	500mV		
17	Cell failure protection	Monomer differential pressure	$> 1\text{V}$ Voltage difference $>1\text{V}$		Charge and discharge are not allowed
18	Full charge judgment	Full charge voltage	56V		
		Cut off current	2A		

7.2. Interface

7.2.1. Interface diagram

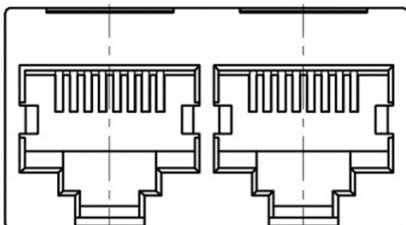

CAN and RS485 interface

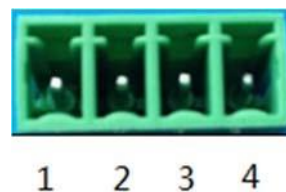

dry contact

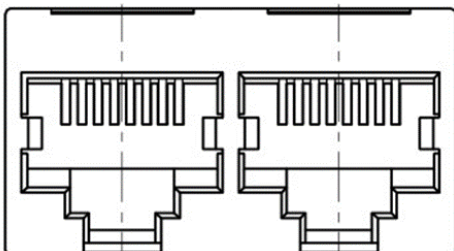

Parallel communication port

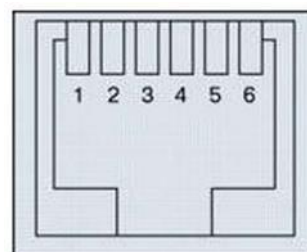

RS232 communication interface

7.2.2. Interface Definition

RS232--Using 6P6C vertical RJ11 socket	
RJ11	Definition description
2	NC
3	TX
4	RX
5	GND

RS485 and CAN interface

RS485--Using 8P8C vertical RJ45 socket		CAN--Using 8P8C vertical RJ45 socket	
RJ45 Pin	Definition description	RJ45 Pin	Definition description
1、 8	RS485-B1	9、 10、 11 、 14、 16	NC
2、 7	RS485-A1	12	CANL
3、 6	GND	13	CANH
4、 5	NC	15	GND

Parallel communication port

RS485--Using 8P8C vertical RJ45 socket		RS485--Using 8P8C vertical RJ45 socket	
RJ45Pin	Definition description	RJ45 Pin	Definition description
1、 8	RS485-B	9、 16	RS485-B
2、 7	RS485-A	10、 15	RS485-A
3、 6	GND	11、 14	GND
4、 5	NC	12、 13	NC

7.3. Communication description

7.3.1. RS232 communication

The BMS can communicate with the host computer through the RS232 interface, so as to monitor various information of the battery on the host computer side, including battery voltage, current, temperature, status, SOC, SOH and battery production information, etc. The default baud rate is 9600bps.

7.3.2. RS485 communication

With dual RS485 interface, you can view the information of PACK, the default baud rate is 9600bps. To communicate with the monitoring device through RS485, the monitoring device is used as the host to poll data according to the address, and the address setting range is 2~15.

7.3.3. CAN communication

CAN communication, baud rate 500K.

8. Product function and performance description

8.1. Charging performance

- ◆ Standard charging current (25°C) : example:0.2C (20A)
- ◆ Standard charging voltage: 54V
- ◆ Standard charging mode and charging curve:

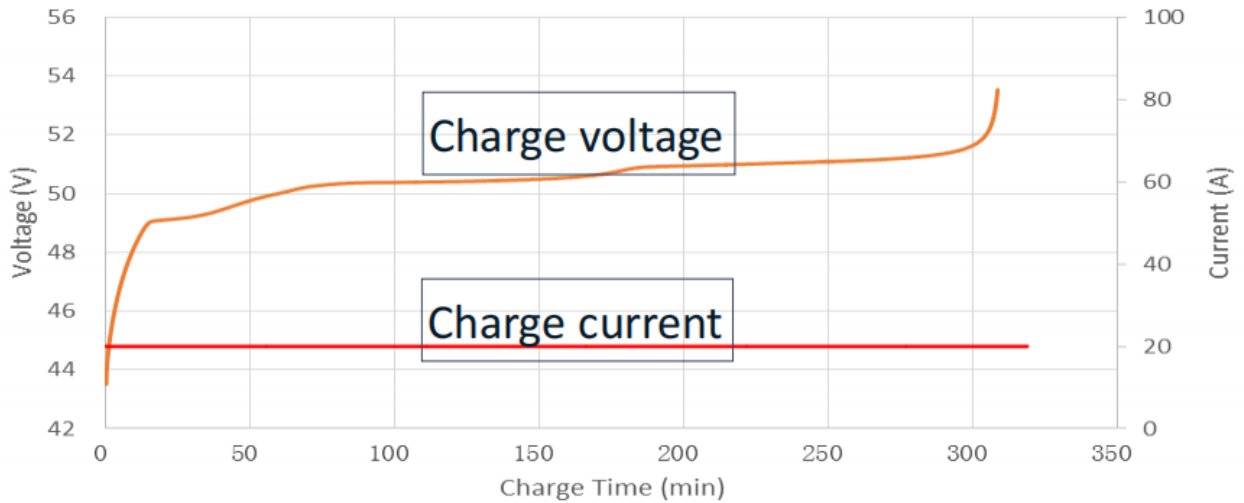

8.2. Discharging performance

Discharge curve at different magnification

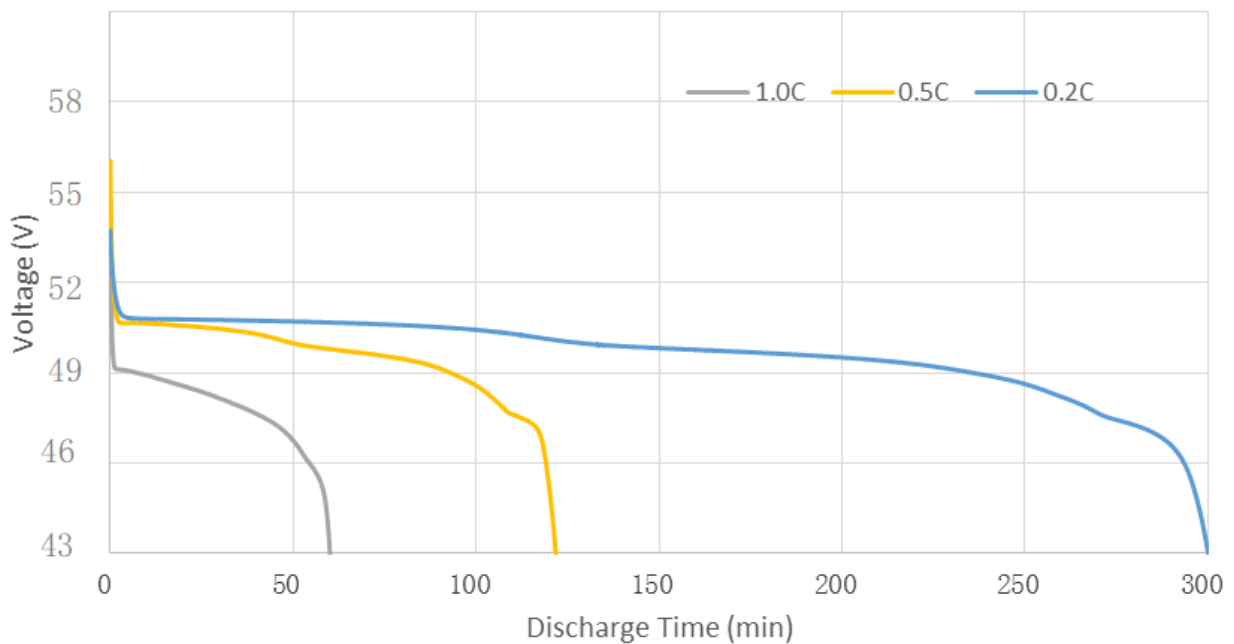

9. Using & Maintenance Suggestions

9.1. LED indication description

Table 1 LED working status indication

Condition	Normal/Alarm/Protect	RUN	ALM	LED Battery indicator LED						Illustrate	
		●	●	●	●	●	●	●	●		
Shutdown	Hibernate	black	black	black	black	black	black	black	black	black	Annihilate
Standby	Normal	flash1	black	According to the battery indicator						Standby mode	
	Alarm	flash1)	flash3							Module low voltage	
Charging	Normal	Always bright)	black	According to the battery indicator (battery indication maximum LED flashes 2)						(The highest power LED flashes (flashing 2), the overcharge alarm ALM does not flash)	
	Alarm	Always bright	3 flash3								
	Overcharge protection	Always bright	black	Always bright	Always bright	Always bright	Always bright	Always bright	Always bright	(If there is no utility power, the indicator light is in standby state)	
	Temperature, overcurrent, fail safe	black	Always bright	black	black	black	black	black	black	black	Stop charging
Discharging	Normal	flash3	black	(According to the battery indicator)							
	Alarm	flash3)	flash3								
	Undervoltage protection	black	black	black	black	black	black	black	black	black	Stop discharge
	Temperature, overcurrent, short circuit, reverse connection, fail safe	black	Always bright	black	black	black	black	black	black	black	Stop discharge
Invalid		black	Always bright	black	black	black	black	black	black	black	Stop charging and discharging

Table 2 Description of capacity indication

Condition		Charging							Discharging				
Capacity indicator		L6●	L5●	L4●	L3●	L2●	L1●	L6●	L5●	L4●	L3●	L2●	L1●
Electricity (%)	0~17%	black	black	black	black	black	flash2	black	black	black	black	black	Always bright
	17~33%	black	black	black	black	flash 2	Always bright	black	black	black	black	Always bright	Always bright
	33~50%	black	black	black	flash 2	Always bright	Always bright	black	black	black	Always bright	Always bright	Always bright

	50~66%	black	black	flash 2	Always bright	Always bright	Always bright	black	black	Always bright	Always bright	Always bright	Always bright
	66-83%	black	flash 2	Always bright	Always bright	Always bright	Always bright	black	Always bright	Always bright	Always bright	Always bright	Always bright
	83-100%	flash 2	Always bright	Always bright	Always bright	Always bright	Always bright	Always bright	Always bright	Always bright	Always bright	Always bright	Always bright
Running lights●				Always bright						flash3			

Table 3 LED flashing description

Flashing method	Bright	Black
flash 1	0.25S	3.75S
flash 2	0.5S	0.5S
flash 3	0.5S	1.5S

Note:

The LED indicator alarm can be enabled or disabled through the host computer, and the factory default is enabled.

9.2. Buzzer action description

- 1) In case of failure, it will beep for 0.25S every 1S;
- 2) During protection, it will beep for 0.25S every 2S (except for overvoltage protection);
- 3) When alarming, it will beep every 3S for 0.25S (except overvoltage alarm);
- 4) The buzzer function can be enabled or disabled by the host computer, and the factory default is disabled.

9.3. Key Description

- 1)When the BMS is in the dormant state, press the button (3~6S) and release it, the protection board will be activated, and the LED indicators will light up in sequence from "RUN" for 0.5 seconds.
- 2)When the BMS is activated, press the button (3~6S) and release it, the protection board is put to sleep, and the LED indicators light up sequentially for 0.5 seconds from the lowest battery light.
- 3)When the BMS is activated, press the button (6~10S) and release it, the protection board will be reset, and all the LED lights will light up at the same time for 1.5 seconds.

After the BMS is reset, it still retains the parameters and functions set by the host computer. If it is necessary to restore the initial parameters, it can be achieved through the "restore default value" of the host computer, but the relevant operation records and stored data remain unchanged (such as power, cycle times, etc.). , protection records, etc.).

9.4. Sleep and wake up

9.4.1. hibernate

When any of the following conditions are met, the system enters a low-power mode:

1. The single or overall over-discharge protection has not been released within 30 seconds.
2. Release the button after pressing the button for 3 seconds.
3. The minimum cell voltage is lower than the sleep voltage, and the duration reaches the sleep delay time (at the same time, no communication, no protection, no balance, and no current are satisfied).
4. The standby time is more than 24 hours (no communication, no charging and discharging, no mains power).
5. Forced shutdown through the host computer software. Before entering the sleep mode, make sure that the input terminal is not connected to an external voltage, otherwise it will not be able to enter the low power consumption mode.

9.4.2. wake

When the system is in low-power mode and meets any of the following conditions, the system will exit the low-power mode and enter the normal operation mode:

1. Connect the charger, the output voltage of the charger must be greater than 48V.
2. Press the button for 3S and release the button.
3. Connect to the communication line and open the software of the upper computer (it enters the sleep state due to over-discharge protection, this method cannot wake up the protection board).

Remarks:

After the single or overall over-discharge protection, it enters the low-power mode, wakes up regularly every 4 hours, and turns on the charge and discharge MOS. If it can be charged, it will exit the dormant state and enter normal charging; if it cannot be charged after 10 consecutive automatic wake-ups, it will no longer automatically wake up.

When the system is defined as the end of charging, the recovery voltage is not reached after 2 days of standby (standby time setting value), and the charging is forced to resume until the end of charging again.

9.5. DIP switch settings

When the battery packs are used in parallel, different PACK can be distinguished by their hardware addresses, and the hardware address of each PACK in the entire battery stack is unique. The hardware addresses can be set in sequence through the DIP switches on the board. Refer to the following for the definition of the switches. surface.

Address Code						ADD	PACK Definition	Explanation
1	2	3	4	5	6			
OFF	OFF	OFF	OFF	/	/	0	PACK0	Use as SlavePack0
ON	OFF	OFF	OFF			1	PACK1	Use as SlavePack1
OFF	ON	OFF	OFF			2	PACK2	Use as SlavePack2
ON	ON	OFF	OFF			3	PACK3	Use as SlavePack3
OFF	OFF	ON	OFF			4	PACK4	Use as SlavePack4
ON	OFF	ON	OFF			5	PACK5	Use as SlavePack5
OFF	ON	ON	OFF			6	PACK6	Use as SlavePack6
ON	ON	ON	OFF			7	PACK7	Use as SlavePack7
OFF	OFF	OFF	ON			8	PACK8	Use as SlavePack8
ON	OFF	OFF	ON			9	PACK9	Use as SlavePack9
OFF	ON	OFF	ON			10	PACK10	Use as SlavePack10
ON	ON	OFF	ON			11	PACK11	Use as SlavePack11
OFF	OFF	ON	ON			12	PACK12	Use as SlavePack12
ON	OFF	ON	ON			13	PACK13	Use as SlavePack13
OFF	ON	ON	ON			14	PACK14	Use as SlavePack14
ON	ON	ON	ON			15	PACK15	Use as SlavePack15

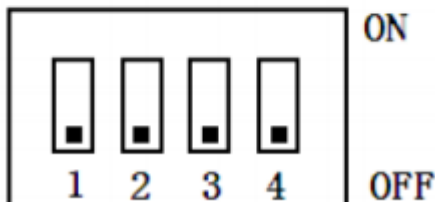

9.6. The routine maintenance of the battery part can be carried out by referring to the table

Period	Item	Treatment measures
Per month	(Operating environment)	Keep away from heat sources and avoid direct sunlight
	Visual inspection	If the appearance is damaged, leaked or deformed, the faulty battery pack should be disconnected, photographed and replaced.
Each quarter	Clean appearance	Clean the exterior with a cotton cloth. Due to the high voltage of the battery pack, care should be taken when cleaning.
	Connection Status	<ul style="list-style-type: none"> ● Check the bolts at each terminal and retighten them if they are loose. ● If the temperature of the connection line exceeds 40°C (feeling hot), check the cause
Every half year	Voltage detection	<ul style="list-style-type: none"> ● At the end of charging, measure and record the busbar voltage and the positive and negative terminal voltages of the battery pack. The voltages of the two are consistent. Otherwise, check whether the cable at the corresponding connection is faulty. ● In the first year, real-time data collection at the end of discharge was performed at least every six months. ● Beginning in the second year, on-site capacity determination will be conducted every three months. If a certain battery cell is frequently overcharged and over-discharged in the historical alarm information viewed through the RS232 interface, it means that the battery cell has touched the charging protection point and the discharging protection point for a long time. This situation may lead to insufficient backup time, it is recommended to replace it in time

The final state of charge and discharge can be judged by the capacity light, refer to the definition of LED light capacity status light.

10. Packing List

See below for packing list

NO.	Material name	Specification/Module	Number
1	48100Ah lithium iron phosphate battery	48100	1 set/box
2	Positive and negative output lines	25mm ² flame retardant cable, length 0.5m, crimp 25-6 copper noses at both ends, one red and one black.	1 set/1 module
3	RS485 cascade communication line	0.5 meters long, with RJ45 crystal heads at both ends.	1root/2 modules
4	RS485 USB RS232 USB	1.5 meters long, one end is the corresponding crystal head, and the other end is the USB interface.	1 set/8 module
5	Product manual	/	1
6	Certificate	/	1
7	Hanging ear screw	M6*16(stud 16mm)	4
8	Dry contact terminal	Matching according to the number of dry nodes of the BMS	1

11.Storage, maintenance and transportation

11.1. Storage

1. The battery pack is usually stored at a state of charge of 20% to 40% in a clean, dry, ventilated and rain-proof room with an ambient temperature of -5°C to 35°C and a relative humidity of not more than 75%, and should be placed flat. Pad height, not less than 100MM from the ground;
2. Batteries cannot be stored with active chemicals or dusting items;
3. The battery cannot be subjected to any mechanical shock or heavy pressure;
4. The battery should avoid direct sunlight, keep away from the fire source, and the distance from the heat source should not be less than 2M;
5. From the date of manufacture, every 3 months of storage should be charged with a current of $0.2\sim 0.5\text{C}$ for 30~60min, and the temperature range is $25^{\circ}\text{C}\pm 5^{\circ}\text{C}$.

11.2. Transportation

The battery pack should be packaged and shipped. During transportation, avoid severe vibration, shock or extrusion, and avoid sun and rain. Batteries can be transported by vehicles such as cars, trains, ships, and planes.

12. Maintain

The battery pack should remain at 40% - 60% of state of charge;

When the battery is not in use for a long time, it is recommended to charge it with 0.2c current every three months or so.

During the maintenance process, do not install or remove the battery in the battery pack by yourself, otherwise the battery performance will be reduced;

Any battery in the battery pack shall not be disassembled or replaced without authorization, and dissection of the battery is strictly prohibited.

13.Battery usage precautions

Please read the instruction manual and precautions carefully before use. When used correctly according to the product characteristics, the battery will be a safe, reliable and convenient storage battery.

Warn! Improper use of lithium-ion batteries can result in personal injury or fire!

1. When charging the battery, pay attention to ensure that the polarity is correct, and do not reverse the charging of the battery;
2. Do not expose the battery to adverse environments, such as extreme temperatures, deep cycling, frequent overcharge/overdischarge;
3. If you find that the battery is abnormal, please stop using it immediately and report it to a professional for treatment;
4. Ensure that batteries and battery management systems are kept away from dangerous goods or dangerous materials;
5. It is forbidden to short-circuit the battery;
6. It is forbidden to burn or destroy the battery, which may cause the release or burning of harmful gases;
7. Do not disassemble, squeeze, pierce or burn.
8. Rain is prohibited;
9. It is forbidden to be directly exposed to sunlight;
10. Prohibit exposure to temperatures above 60°C;
11. It is forbidden to discard the battery in the garbage;
12. It is forbidden to use other types of batteries in series or in parallel with lithium-ion batteries;
13. It is forbidden to use new and old batteries (groups) in series or in parallel.

14. Product Liability

Consumers must strictly abide by the requirements of this product specification to use this product. Misuse may lead to serious accidents. The company is not responsible for any accidents caused by the operation and use that are not strictly in accordance with this product specification. The company reserves the right to change the contents of this specification without prior notice; the final interpretation right of this information belongs to the company.

LF-PV Series

Pure Sine Wave Inverter

For All Home & Office Appliances

User's Manual

Version 1.0

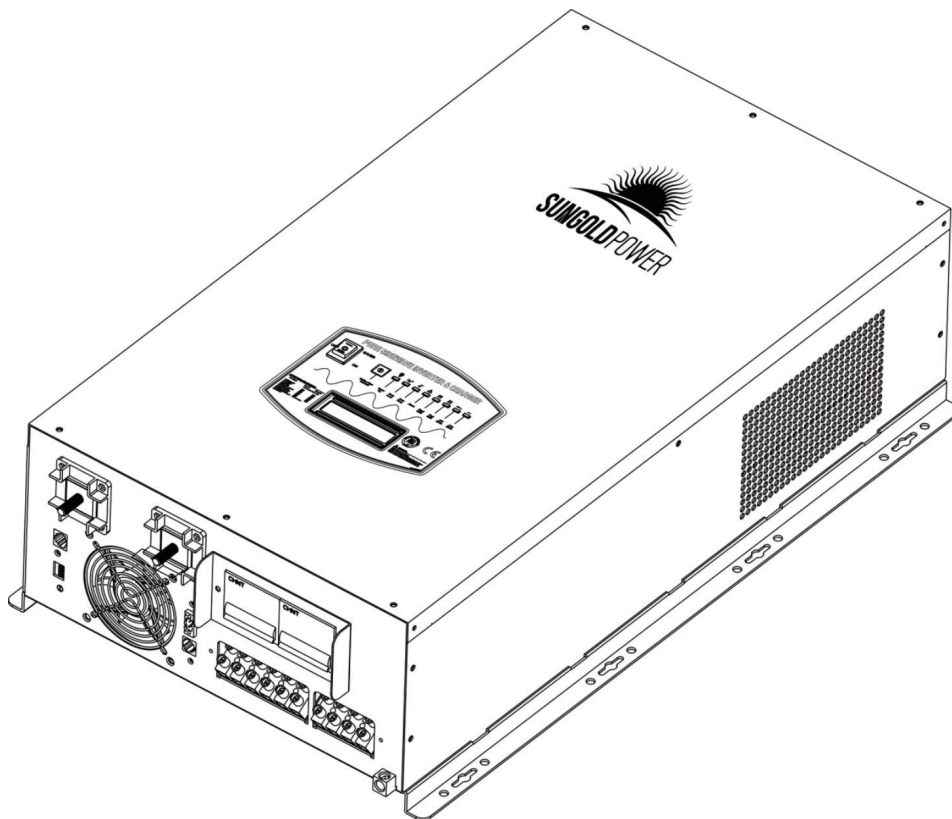

Utility + Inverter + Charger + Transfer SW + Solar Power + AGS

All in One

LF-PV Series Inverter/Charger

Installation and Operation Manual

Table of Contents

1. Important Safety Information.....	- 5 -
1.1 General Safety Precautions.....	- 5 -
1.2 Precautions When Working with Batteries.....	- 5 -
2. Introduction.....	- 6 -
2.1 General Information.....	- 6 -
2.2 Application.....	- 7 -
2.3 The Mechanical Drawing of LF-PV Series.....	- 7 -
2.3.1 The Front Side Mechanical Drawing of LF-PV 4-12KW Series.....	- 7 -
2.3.2 The Front Side Mechanical Drawing of LF-PV 4-12KW Series.....	- 8 -
2.3.3 The Rear Side Mechanical Drawing of LF-PV 4-6KW Series.....	- 8 -
2.3.4 The Front Side Mechanical Drawing of LF 15-18KW Series.....	- 9 -
2.3.5 The Front Side Mechanical Drawing of LF 15-18KW Series.....	- 9 -
2.3.6 The Rear Side Mechanical Drawing of LF 8-18KW Series.....	- 10 -
2.4 Features.....	- 10 -
2.5 Electrical Performance.....	- 11 -
2.5.1 Inverter.....	- 11 -
2.5.2 AC Charger.....	- 11 -
2.5.3 Transfer.....	- 13 -
2.5.4 Frequency adjust.....	- 13 -
2.5.5 Solar Charger.....	- 14 -
2.5.6 Automatic Voltage Regulation(Optional).....	- 15 -
2.5.7 Power Saver Mode.....	- 16 -
2.5.8 Protections.....	- 18 -
2.5.9 Remote control Module.....	- 18 -
2.5.10 LED Indicator & LCD.....	- 19 -
2.5.11 Audible Alarm.....	- 20 -
2.5.12 FAN Operation.....	- 20 -
2.5.13 DIP Switches.....	- 21 -
2.5.14 Output Socket.....	- 22 -
2.5.15 Other features.....	- 22 -
3 Installation.....	- 23 -
3.1 Location.....	- 23 -
3.2 DC Wiring recommendation.....	- 23 -
3.3 AC Wiring.....	- 25 -
3.4 Install Flange.....	- 28 -
4 Battery Information.....	- 30 -
4.1 Battery Type.....	- 30 -
4.2 Battery Capacity Rating.....	- 30 -
4.2.1 Battery Discharge Rate.....	- 30 -
4.2.2 Depth of Discharge.....	- 31 -
4.2.3 Understanding Amp-Hour Requirements.....	- 31 -
4.2.4 Battery Configurations.....	- 31 -
4.2.5 Wiring Batteries.....	- 32 -
4.2.6 Batteries Maintenance.....	- 33 -
5 Troubleshooting Guide.....	- 34 -
6 Warranty.....	- 37 -
7 Ordering Information.....	- 37 -
Appendix 1.....	- 38 -
Appendix 2 Battery Temperature Compensation (BTS).....	- 40 -

1. Important Safety Information



WARNING!

This manual contains important instructions for all LF-PV Inverter/Charger models that shall be followed during installation and maintenance of the inverter.

1.1 General Safety Precautions

1. Before installing and using the LF Inverter/Charger, read all instructions and cautionary markings on the LF Inverter /Charger and all appropriate sections of this guide. Be sure to read all instructions and cautionary markings for any equipment attached to this unit.
2. This unit is designed for indoor use only. Do not expose the LF Inverter/Charger to rain, snow, or spray.
3. To reduce risk of fire hazard, do not cover or obstruct the ventilation openings. Do not install the LF Inverter/Charger in a zero-clearance compartment. Overheating may result.
4. Use only attachments recommended or sold by the manufacturer. Doing otherwise may result in a risk of fire, electric shock, or injury to persons.
5. To avoid a risk of fire and electric shock, make sure that existing wiring is in good condition and that wire is not undersized. Do not operate the LF Inverter/Charger with damaged or substandard wiring.
6. Do not operate the LF Inverter/Charger if it has received a sharp blow, been dropped, or otherwise damaged in any way. If the LF Inverter/Charger is damaged, see the Warranty section.
7. Do not disassemble the LF Inverter/Charger. It contains no user-serviceable parts. See Warranty for instructions on obtaining service. Attempting to service the LF Inverter/Charger yourself may result in a risk of electrical shock or fire. Internal capacitors remain charged after all power is disconnected.
8. The LF Inverter contains more than one live circuit (batteries and AC line). Power may be present at more than one source. To reduce the risk of electrical shock, disconnect both AC and DC power from the LF Inverter/Charger before attempting any maintenance or cleaning or working on any circuits connected to the LF Inverter/Charger. Turning off controls will not reduce this risk.
9. Use insulated tools to reduce the chance of short-circuits when installing or working with the inverter, the batteries, or PV array.

1.2 Precautions When Working with Batteries

1. Make sure the area around the battery is well ventilated.
2. Never smoke or allow a spark or flame near the engine or batteries.
3. Use caution to reduce the risk of dropping a metal tool on the battery. It could spark or short circuit the battery or other electrical parts and could cause an explosion.
4. Remove all metal items, like rings, brace lets, and watches when working with lead-acid batteries. Lead-acid batteries produce a short circuit current high enough to weld metal to skin, causing a severe burn.
5. Have someone within range of your voice or close enough to come to your aid when you work near a lead-acid battery.
6. Have plenty of fresh water and soap near by in case battery acid contacts skin, clothing, or eyes.
7. Wear complete eye protection and clothing protection. Avoid touching your eyes while working near batteries.
8. If battery acid contacts skin or clothing, wash immediately with soap and water. If acid enters your eye, immediately flood it with running cold water for at least twenty minutes and get medical attention immediately.
9. If you need to remove a battery, always remove the grounded terminal from the battery first. Make sure

all accessories are off so you don't cause a spark.

10. Always use identical types of batteries.
11. Never install old or untested batteries. Check each battery's date code or label to ensure age and type.
12. Batteries are temperature sensitive. For optimum performance, they should be installed in a stable temperature environment.
13. Always recycle old batteries. Contact your local recycling center for proper disposal information.

2. Introduction

2.1 General Information

Thank you for purchasing the LF Series Inverter/Charger.

LF-PV Series Pure Sine Wave Inverter is a combination of an inverter, charger, solar power and Auto-transfer switch into one complete system. It is packed with unique features and it is one of the most advanced inverter/chargers in the market today.

The inverter features an AC pass-through circuit, powering your home appliances from utility or generator power while charging the battery. When utility power fails, the battery backup system keeps your appliances powered until utility power is restored. Internal protection circuits prevent over-discharge of the batteries by shutting down the inverter when a low battery condition occurs. When utility or generator power is restored, the inverter transfers to the AC source and recharges the batteries.

Accessories allow the LF-PV series to also serve as a central hub of a renewable energy system. Set the LF-PV Series inverter to battery priority mode, designates the inverter-preferred UPS configuration. In this configuration, the load power is normally provided by the inverter. However, if the inverter output is interrupted, an internal transfer switch automatically transfers the load from the inverter to commercial AC power. The transfer time between inverter and line is short (6ms typical), and such transfers are normally not detected by even highly sensitive loads. Upon restoration of inverter power, the inverter will transfer back to inverter power.

On the line priority mode, when utility AC power cuts off (or falls out of acceptable range), the transfer relay is de-energized and the load is automatically transferred to the Inverter output. Once the qualified AC utility is restored, the relay is energized and the load is automatically reconnected to AC utility.

It features power factor corrected, sophisticated multi-stage charging and pure sine wave output with unprecedentedly high surge capability to meet demanding power needs of inductive loads without endangering the equipment.

LF-PV Series Inverter is equipped with a powerful charger of up to 120Amp (depending on Model). The overload capacity is 300% of continuous output for up to 20 seconds to reliably support tools and equipment longer.

Another important feature is that the inverter can be easily customized to Battery priority via a DIP switch, this helps to extract maximum power from battery in renewable energy systems. Thus, the LF-PV Series Pure Sine Wave Inverter is suitable for Renewable energy system, Utility, RV, Marine and Emergency appliances.

To get the most out of the power inverter, it must be installed, used and maintained properly. Please read the instructions in this manual before installing and operating.

2.2 Application

Power tools—circular saws, drills, grinders, sanders, buffers, weed and hedge trimmers, air compressors.
 Office equipment – computers, printers, monitors, facsimile machines, scanners.
 Household items – vacuum cleaners, fans, fluorescent and incandescent lights, shavers, sewing machines.
 Kitchen appliances – coffee makers, blenders, ice makers, toasters.
 Industrial equipment – metal halide lamp, high – pressure sodium lamp.
 Home entertainment electronics – television, VCRs, video games, stereos, musical instruments, satellite equipment.

2.3 The Mechanical Drawing of LF-PV Series

2.3.1 The Front Side Mechanical Drawing of LF-PV 4-12KW Series

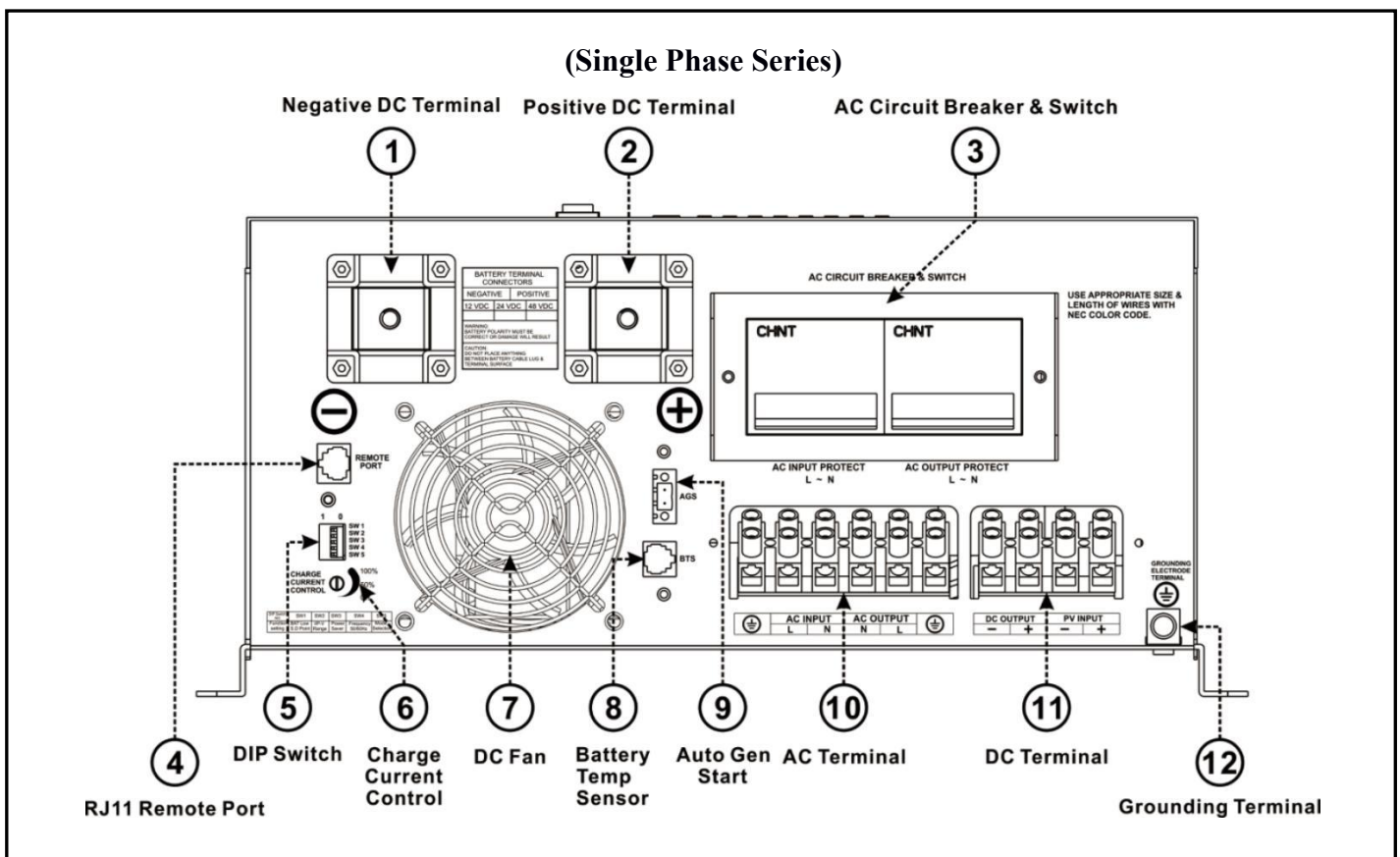

2.3.2 The Front Side Mechanical Drawing of LF-PV 4-12KW Series

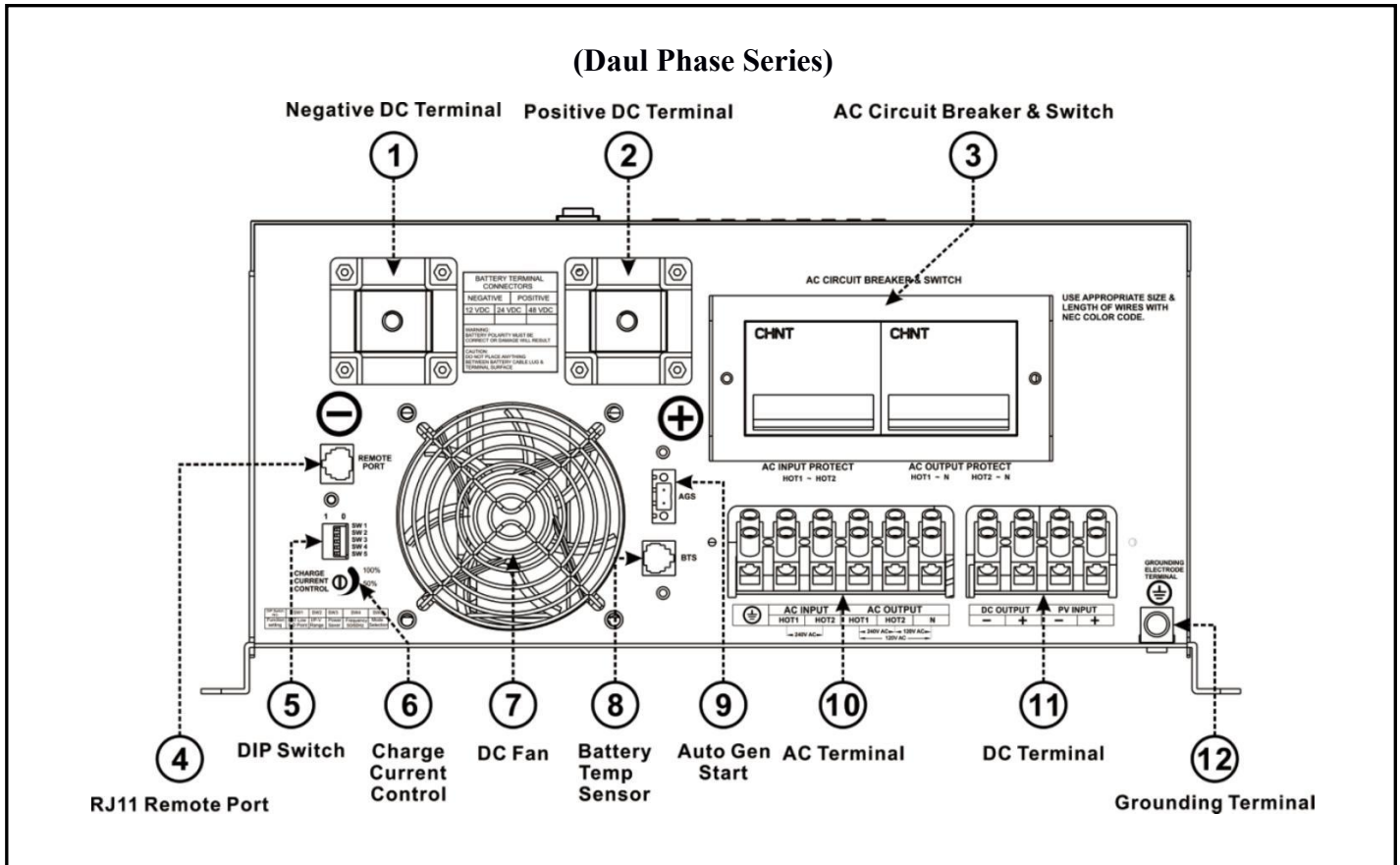

2.3.3 The Rear Side Mechanical Drawing of LF-PV 4-6KW Series

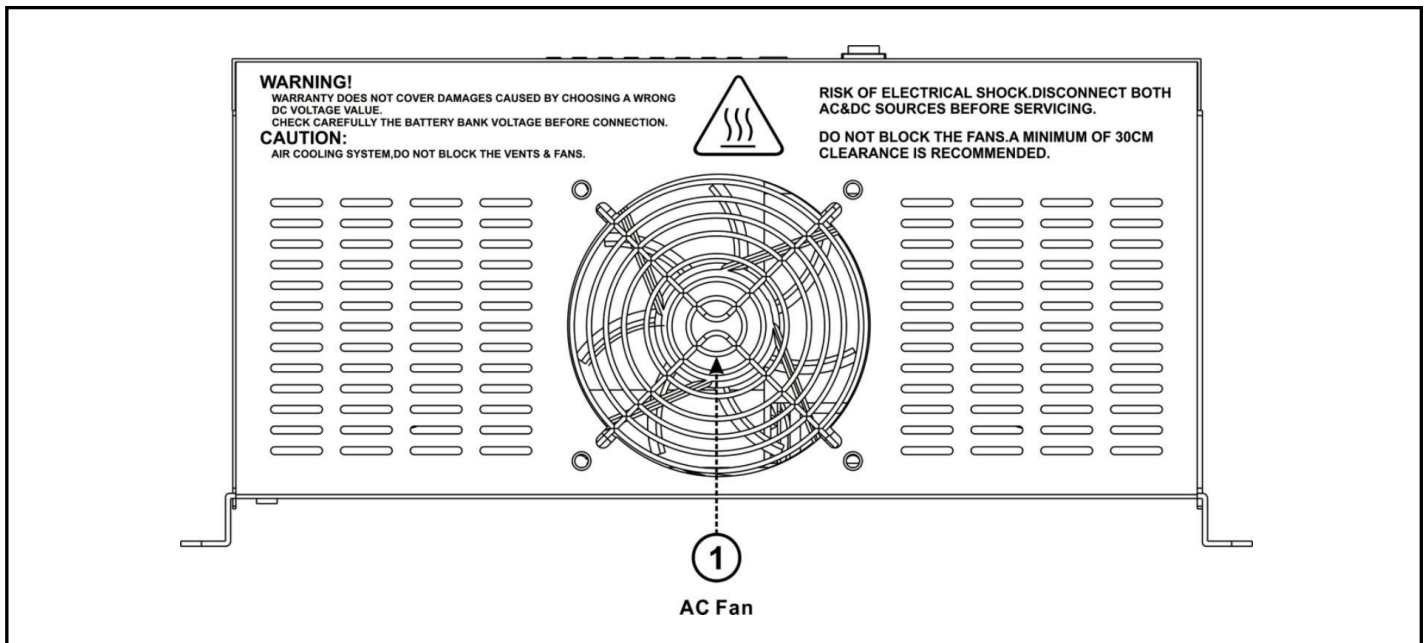

2.3.6 The Rear Side Mechanical Drawing of LF 8-18KW Series

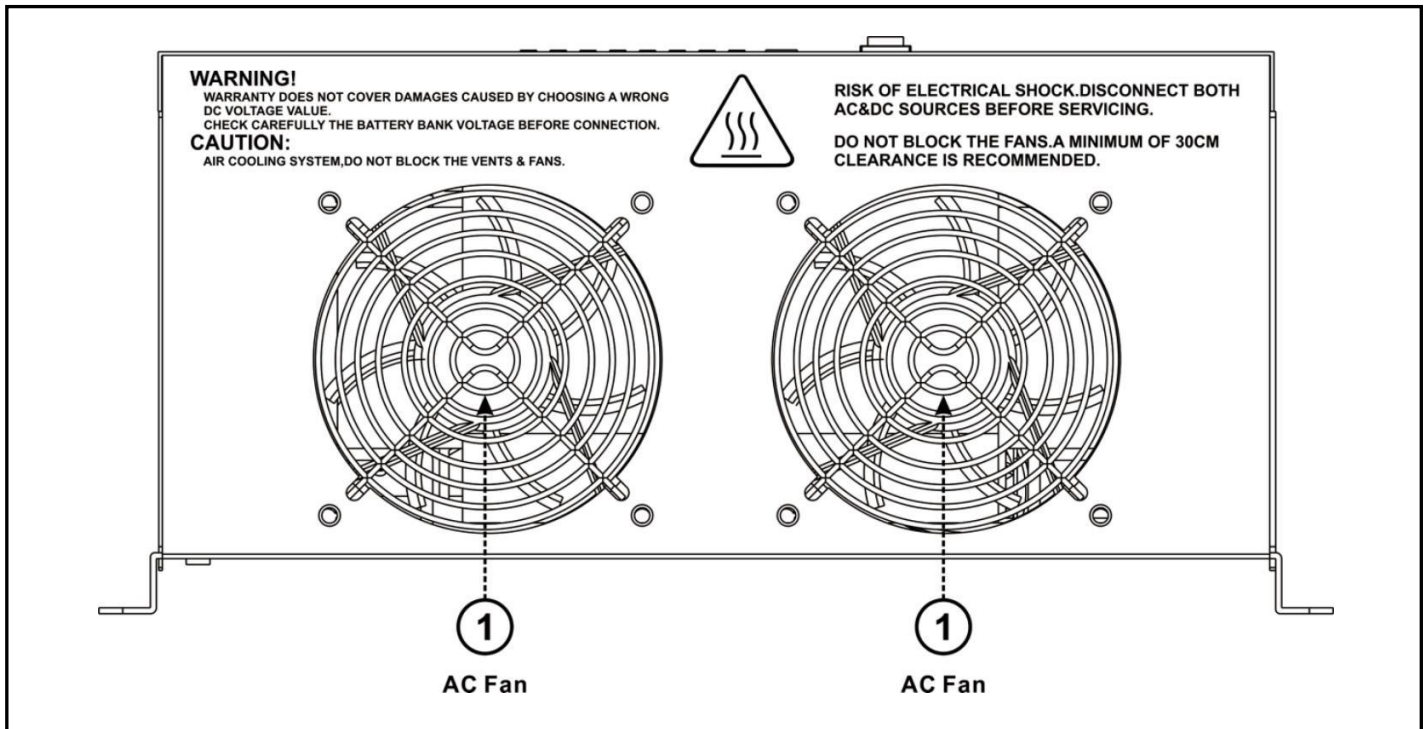

2.4 Features

- ❖ Smart Remote Control (RJ11 or RJ45)
- ❖ Battery Temperature Sensor (BTS)
- ❖ Automatic Generator Start (AGS)
- ❖ Support Solar Panel with MPPT Function
- ❖ Designed For Harsh Environment Operation
- ❖ DC Start & Automatic Self-Diagnostic Function
- ❖ Compatible With Linear & Non-Linear Load
- ❖ Easy to Install & Easy to Operate & Easy to Solve
- ❖ Low DC Voltage Supports Home & Office Appliances
- ❖ Powerful Charge Rate Up to 120Amp, Selectable From 0%-100%
- ❖ High Efficiency Design & “Power Saving Mode” to Conserve Energy
- ❖ Battery Priority Mode, Designates the Inverter-Preferred UPS Configuration
- ❖ 13 Vdc Battery Recover Point, Dedicated for Renewable Energy Systems
- ❖ 8 pre Set Battery Type Selector plus De-sulphation for Totally Flat Batteries
- ❖ 4-step Intelligent Battery Charging, PFC (Power Factor Correction) for Charger
- ❖ 8 ms Typical Transfer Time Between Utility & Battery, Guarantees Power Continuity
- ❖ 15s Delay Before Transfer when AC Recover, Protection for Load when Used with Generator

2.5 Electrical Performance

2.5.1 Inverter

Topology

The LF-PV inverter/charger is built according to the following topology.

Inverter: Full Bridge Topology.

AC Charger: Isolate Boost Topology

Solar Charger: MPPT PV Controller

Because of high efficiency IGBT and 16bit, 4.9MHz microprocessor and heavy transformers, it outputs PURE SINE WAVE Waveform with an average THD of 8% (Max 10%) depending of load connected and battery voltage.

The peak efficiency of LF-PV series is 88%.

Overload Capacity

The LF-PV series inverters have different overload capacities, making it ideal to handle demanding loads.

1 For $110% < \text{Load} < 125% (\pm 10\%)$, no audible alarm in 14 minutes, beeps 0.5s every 1s in the 15th minute, and Fault(Turn off) after the 15th minute.

2 For $125% < \text{Load} < 150% (\pm 10\%)$, beeps 0.5s every 1s and Fault(Turn off) after the 1 minute.

3 For $300\% \geq \text{Load} > 150% (\pm 10\%)$, beeps 0.5s every 1s and Fault(Turn off) after 20s.

2.5.2 AC Charger

LF Series is equipped with an active PFC (Power Factor Corrected) multistage battery charger. The PFC feature is used to control the amount of power used to charge the batteries in order to obtain a power factor as close as possible to 1.

Unlike other inverters whose max charging current decreases according to the input AC voltage, LF-PV series charger is able to output max current as long as input AC voltage is in the range of 164-243VAC (95-127VAC for 120V model), and AC freq is in the range of 48-54Hz(58-64Hz for 60Hz model).

The LF-PV series inverter is with a strong charging current of 120Amp (for 4KW,12V), and the max charge current can be adjusted from 0%-100% via a linear switch at the right of the battery type selector. This will be helpful if you are using our powerful charger on a small capacity battery bank. Fortunately, the linear switch can effectively reduce the max charging current to 20% of its peak.

Choosing "0" in the battery type selector will disable charging function.

There are mainly 3 stages:

Bulk Charging: This is the initial stage of charging. While Bulk Charging, the charger supplies the battery with controlled constant current. The charger will remain in Bulk charge until the Absorption charge voltage (determined by the Battery Type selection) is achieved.

Software timer will measure the time from A/C start until the battery charger reaches 0.3V below the boost voltage, then take this time as T_0 and $T_0 \times 2 = T_1$.

Absorb Charging: This is the second charging stage and begins after the absorb voltage has been reached.

Absorb Charging provides the batteries with a constant voltage and reduces the DC charging current in order to maintain the absorb voltage setting.

In this period, the inverter will start a T_1 timer; the charger will keep the boost voltage in Boost CV mode until the T_1 timer has run out. Then drop the voltage down to the float voltage. The timer has a minimum time of 1 hour and a maximum time of 12 hours.

Float Charging: The third charging stage occurs at the end of the Absorb Charging time. While Float charging, the charge voltage is reduced to the float charge voltage (determined by the Battery Type selection*). In this stage, the batteries are kept fully charged and ready if needed by the inverter.

If the A/C is reconnected or the battery voltage drops below 12Vdc/24Vdc/48Vdc, the charger will reset the

cycle above.

If the charge maintains the float state for 10 days, the charger will deliberately reset the cycle to protect the battery.

Table 2.5.1 Battery Charging Processes

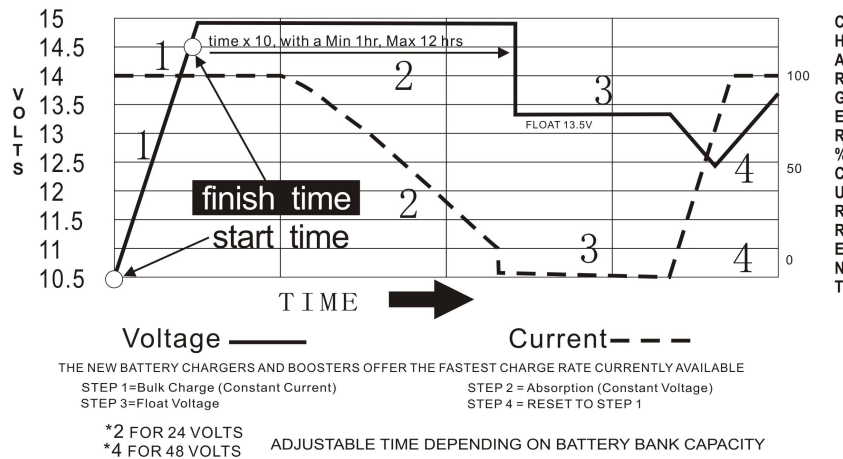

Table 2.5.2 Battery Type Selector

Switch Setting	Description	Fast Mode / VDC	Float Mode / VDC
0	Charger Off		
1	Gel USA	14.0	13.7
2	AGM 1	14.1	13.4
3	Lithium	13.8	13.6
4	Sealed Lead Acid	14.4	13.6
5	Gel EURO	14.4	13.8
6	Open Lead Acid	14.8	13.3
7	LiFePO4	14.0	13.8
8	De-sulphation	15.5 (4 Hours then Off)	
9	Classic LFP	13.6	13.5

For 12Vdc Battery Mode (*2 for 24Vdc Mode ; *4 for 48Vdc Mode)

De-sulphation

The de-sulphation cycle on switch position 8 is marked in red because this is a very dangerous setting if you do not know what you are doing. Before ever attempting to use this cycle you must clearly understand what it does and when and how you would use it.

What causes sulphation? This can occur with infrequent use of the batteries(nor), or if the batteries have been left discharged so low that they will not accept a charge. This cycle is a very high voltage charge cycle designed to try to break down the sulfated crust that is preventing the plates taking a charge and thus allow the plates to clean up and so accept charge once again.

Charging depleted batteries

The LF-PV series inverter allows start up and through power with depleted batteries.

For 12VDC model, after the battery voltage goes below 10V, if the switch is still (and always) kept in "ON" position, the inverter is always connected with battery, and the battery voltage does not drop below 2V, the inverter will be able to charge the battery once qualified AC inputs are present.

Before the battery voltage goes below 9VDC, the charging can be activated when the switch is turned to "Off", then to "ON".

When the voltage goes below 9VDC, and you accidently turn the switch to OFF or disconnect the inverter from battery, the inverter will not be able to charge the battery once again, because the CPU loses memory during this process.

Tabel 2.5.3 AC Charging Current for LF model

Model Watt	Battery Voltage	AC Charger Current Max	Model Watt	Battery Voltage	AC Charger Current Max
1.000	12 Vdc	35 ± 5 Amp	2.000	12 Vdc	60 ± 5 Amp
	24 Vdc	20 ± 5 Amp		24 Vdc	30 ± 5 Amp
	48 Vdc	10 ± 5 Amp		48 Vdc	15 ± 5 Amp
3.000	12 Vdc	80 ± 5 Amp	4.000	12 Vdc	100 ± 5 Amp
	24 Vdc	45 ± 5 Amp		24 Vdc	55 ± 5 Amp
	48 Vdc	25 ± 5 Amp		48 Vdc	35 ± 5 Amp
5.000	24 Vdc	65 ± 5 Amp	6.000	24 Vdc	80 ± 5 Amp
	48 Vdc	40 ± 5 Amp		48 Vdc	50 ± 5 Amp
8.000	24 Vdc	100 ± 5 Amp	10.000	48 Vdc	80 ± 5 Amp
	48 Vdc	65 ± 5 Amp	12.000	48 Vdc	120 ± 5 Amp
15.000	48 Vdc	100 ± 5 Amp	18.000	48 Vdc	100 ± 5 Amp

The charging capacity will go to peak in around 3 seconds. This may cause a generator to drop frequency, making inverter transfer to battery mode.

It is suggested to gradually put charging load on the generator by switching the charging switch from min to max, together with the 15s switch delay, our inverter gives the generator enough time to spin up. This will depend on the size of the generator and rate of charge.

2.5.3 Transfer

While in the Standby Mode, the AC input is continually monitored. Whenever AC power falls below the VAC Trip voltage (154 VAC, default setting for 230VAC,90VAC for 120VAC), the inverter automatically transfers back to the Inverter Mode with minimum interruption to your appliances - as long as the inverter is turned on. The transfer from Standby mode to Inverter mode occurs in approximately 8 milliseconds. And it is the same time from Inverter mode to Standby mode.

Though it is not designed as a computer UPS system, this transfer time is usually fast enough to keep your equipment powered up.

There is a 15-second delay from the time the inverter senses that continuously qualified AC is present at the input terminals to when the transfer is made. This delay is built in to provide time for a generator to spin-up to a stable voltage and avoid relay chattering. The inverter will not transfer to generator until it has locked onto the generator's output. This delay is also designed to avoid frequent switching when input utility is unstable.

2.5.4 Frequency adjust

The frequency of the inverter is arranged by the SW4. Refer to the Table 2.5.11.

The factory default configuration for 220/230/240VAC inverter is 50Hz, and 60Hz for 100/110/120VAC inverter. While the output freq can be easily changed once a qualified freq is applied to the inverter.

2.5.5 Solar Charger

Listed below is the spec for solar charger

Table 2.5.4 Solar Charge Electrical Specification @ 25°C

Rated Voltage	12Vdc	24Vdc	48Vdc
Rated Charge Current (Includes Load Current)	80Amp		
Load Ccurrent	15Amp		
Input Voltage Range	15-145Vdc	30-145Vdc	60-145Vdc
Max. PV Open Circuit Array Voltage	145Vdc		
Overload Protection (DC load)	2.0 * I(Rated)>5s; 1.5 * I(Rated) >20s 1.25 * I(Rated) Temperature Controlled		
Typical Idle Consumption	At idle < 10mA		
Bulk Charge	14.6Vdc	29.2Vdc	58.4Vdc
Floating Charge	13.4Vdc	26.8Vdc	53.6Vdc
Equalization Charge	14.0Vdc	28.0Vdc	58.0Vdc
Over Charge Disconnect	14.8Vdc	29.6Vdc	59.2Vdc
Over Charge Recovery	13.6Vdc	27.2Vdc	54.4Vdc
Over Discharge Disconnect	10.8Vdc	21.6Vdc	43.2Vdc
Over Discharge Reconnect	12.3Vdc	24.6Vdc	49.6Vdc
Temperature Compensation	-13.2mV/°C	-26.4mV/°C	-52.8mV/°C
Lead Acid Battery Settings	Adjustable		
NiCad Battery Settings	Adjustable		
Low Voltage Reconnect	12.0-14.0Vdc	24.0-28.0Vdc	48.0-56.0Vdc
Low Voltage Disconnect	10.5-12.5Vdc	21.0-25.0Vdc	42.0-50.0Vdc
Ambient Temperature	0-40°C (Full load) 40-60°C (De-rating)		
Altitude	Operating 5000m, Non-Operating 16000m		
Battery Temperature Sensor①	BTS (Optional) Remote Battery Temperature Sensor for Increased Charging Precision		
Terminal Size (Fine/Single Wire)	#8 AWG		

NOTE:

①The optional battery temperature sensor automatically adjusts the charging process of the controller according to the type of battery that is selected by user through battery type selector. With the battery temperature sensor installed, the controller will increase or decrease the battery charging voltage depending on the temperature of the battery to optimize the charge to the battery and maintain optional performance of the battery.

Maximum Power Point Tracking (MPPT) Function

Maximum Power Point Tracking, frequently referred to as MPPT, is an electronic system that operates the Photovoltaic (PV) modules in a manner that allows the modules to produce all the power they are capable of. The PV-seeker Charge controller is a microprocessor-based system designed to implement the MPPT. And it can increase charge current up to 30% or more compared to traditional charge controllers

(See Table 2.5.4).

Table 2.5.5 Current, Power Vs. Voltage Characteristics

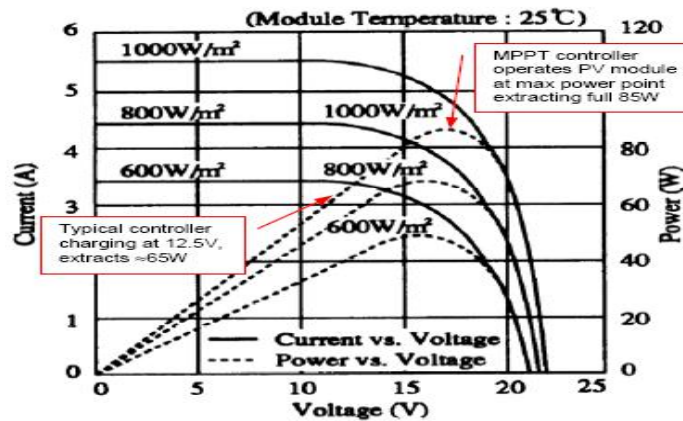

The Charge controller built in is with 12/24/48V battery voltage auto detecting function. The output voltage of solar charger will be accordingly 12/24/48VDC. The qualified DC input voltage range for 12VDC inverter is 15 -145VDC, for 24VDC inverter is 30 -145VDC and for 48VDC inverter is 60 -100VDC.

If the voltage falls out of this range, the charger will not work properly. Special attention should be paid to this when configuring the solar array.

2.5.6 Automatic Voltage Regulation(Optional)

The automatic voltage regulation function is for full series of LF Pure Sine Wave Inverter/ Charger except split phase models including LF1000W~6000W.

Instead of simply bypassing the input AC to power the loads, the LF-PV series inverter stabilizes the input AC voltage to a range of 230V/120V ± 10%.

Connected with batteries, the LFS Series inverter will function as a UPS with max transfer time of 10 ms.

With all the unique features our inverter provides, it will bring you long-term trouble free operation beyond your expectation.

Function Introduction

Table 2.5.5 Input Voltage Transfer Points

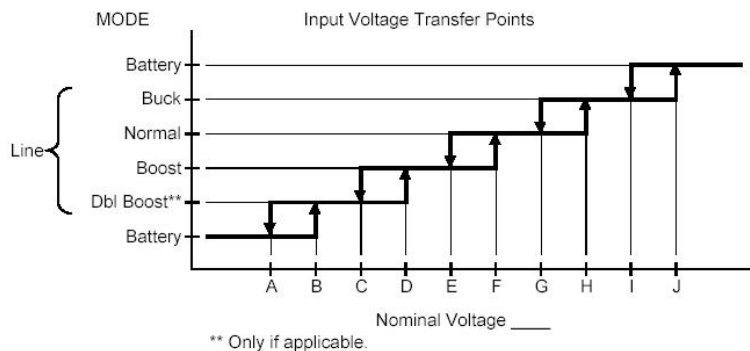

LF-PV Function (Optional)	LF-PV Series					
	LV (NA/JPN)			HV (INTL)		
Acceptable Input Voltage Range (Vac)	0-160			0-300		
Nominal Input Voltages (Vac)	100	110	120	220	230	240
(A) Line low loss N/W (On battery)	75/65	84/72	92/78	168/143	176/150	183/156
(B) Line Low comeback N/W (On Boost)	80/70	89/77	97/83	178/153	186/160	193/166
(C) Line 2nd boost threshold (On Boost)	**	**	**	**	**	**
(D) Line 2nd boost comeback (On Normal)	**	**	**	**	**	**
(E) Line 1st boost threshold (On Boost)	90	99	108	198	207	216
(F) Line 1st boost comeback (On Normal)	93	103	112	205	215	225
(G) Line buck comeback (On Normal)	106	118	128	235	246	256
(H) Line buck threshold (On Buck)	110	121	132	242	253	264
(I) Line high comeback (On Buck)	115	127	139	253	266	278
(J) Line high loss (On Battery)	120	132	144	263	276	288

2.5.7 Power Saver Mode

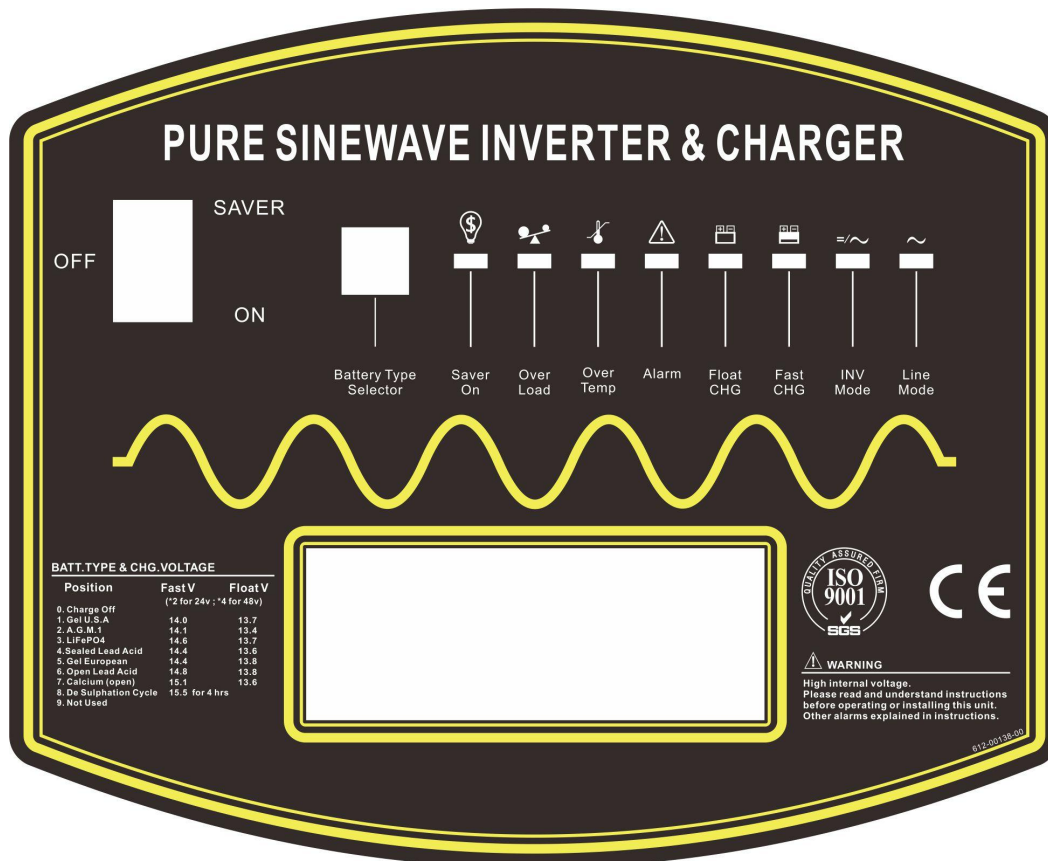

There are 3 different working status for LF inverter: “Power Saver Auto” , “Power Saver Off” and “Power Off”.

When power switch is in “Unit Off” position, the inverter is powered off.

When power switch is turned to either of “Power Saver Auto” or “Power Saver Off”, the inverter is powered on. Power saver function is designed to conserve battery power when AC power is not or rarely required by the loads.

In this mode, the inverter pulses the AC output looking for an AC load (i.e., electrical appliance). Whenever an AC load (greater than 25 watts) is turned on, the inverter recognizes the need for power and automatically starts inverting and output goes to full voltage. When there is no load (or less than 25 watts) detected, the inverter automatically goes back into search mode to minimize energy consumption from the battery bank. In “Power saver on” mode, the inverter will draw power mainly in sensing moments, thus the idle consumption is significantly reduced.



Note: The minimum power of load to take inverter out of sleep mode (Power Saver On) is 25 Watts.

Table 2.5.6 LF Series Idle Power Consumption

Model	Power Saver Off	Power Saver Auto	
	Idle(Max)	3Secs(Max)	Stand-By Mode
1.0KW	18W	7.5W	2.5W
1.5KW	18W	7.5W	
2.0KW	30W	10.0W	
3.0KW	60W	15.0W	
4.0KW	70W	20.0W	
5.0KW	80W	25.0W	
6.0KW	90W	25.0W	
8.0KW	120W	30.0W	
10.0KW	150W	35.0W	
12.0KW	180W	40.0W	
15.0KW	225W	45.0W	
18.0KW	270W	50.0W	

When in the search sense mode, the green power LED will blink and the inverter will make a ticking sound. At full output voltage, the green power LED will light steadily and the inverter will make a steady humming sound. When the inverter is used as an “Un-interruptible power supply” the search sense mode or “Power Saver On” function should be defeated.

Exceptions

Some devices when scanned by the load sensor cannot be detected. Small fluorescent lights are the most common example. (Try altering the plug polarity by turning the plug over.) Some computers and sophisticated electronics have power supplies that do not present a load until line voltage is available. When this occurs, each unit waits for the other to begin. To drive these loads either a small companion load must be used to bring the inverter out of its search mode, or the inverter may be programmed to remain at full output voltage.

2.5.8 Protections

The LF-PV series inverter is equipped with extensive protections against various harsh situations/faults. These protections include:

AC Input over voltage protection/AC Input low voltage protection

Low battery alarm/High battery alarm

Over temperature protection/Over load protection

Short Circuit protection (1sec after fault)

Back feeding protection

When Over temperature /Over load occur, after the fault is cleared, the master switch has to be reset to restart the inverter.

The Low batter voltage trip point can be customized from defaulted value 10VDC to 10.5VDC turn the SW1 on DIP switch.

The inverter will go to Over temp protection when heat sink temp. $\geq 105^{\circ}\text{C}$, and go to Fault (shutdown Output) after 30 seconds. The switch has to be reset to activate the inverter.

The LF series Inverter has back feeding protection which avoids presenting an AC voltage on the AC input terminal in Invert mode.

After the reason for fault is cleared, the inverter has to be reset to start working.

2.5.9 Remote control Module

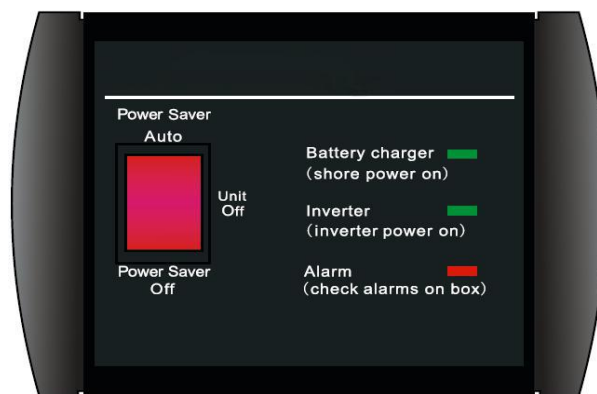

Apart from the switch panel on the front of the inverter, an extra switch panel connected to the RJ11 port at the DC side of the inverter thru a standard telephone cable can also control the operation of the inverter.

If an extra switch panel is connected to the inverter via “remote control port”, together with the panel on the inverter case, the two panels will be connected and operated in parallel.

Whichever first switches from “Off” to “Power saver off” or “Power saver on”, it will power the inverter on. If the commands from the two panels conflict, the inverter will accept command according to the following priority:

Power saver on> Power saver off> Power off

Only when both panels are turned to “Unit Off” position will the inverter be powered off.

The Max length of the cable is 10 meters.



WARNING

Never cut the telephone cable when the cable is attached to inverter and battery is connected to the inverter. Even if the inverter is turned off. It will damage the remote PCB inside if the cable is short circuited during cutting.

2.5.10 LED Indicator & LCD

Table 2.5.7 LF Series LED Indicators

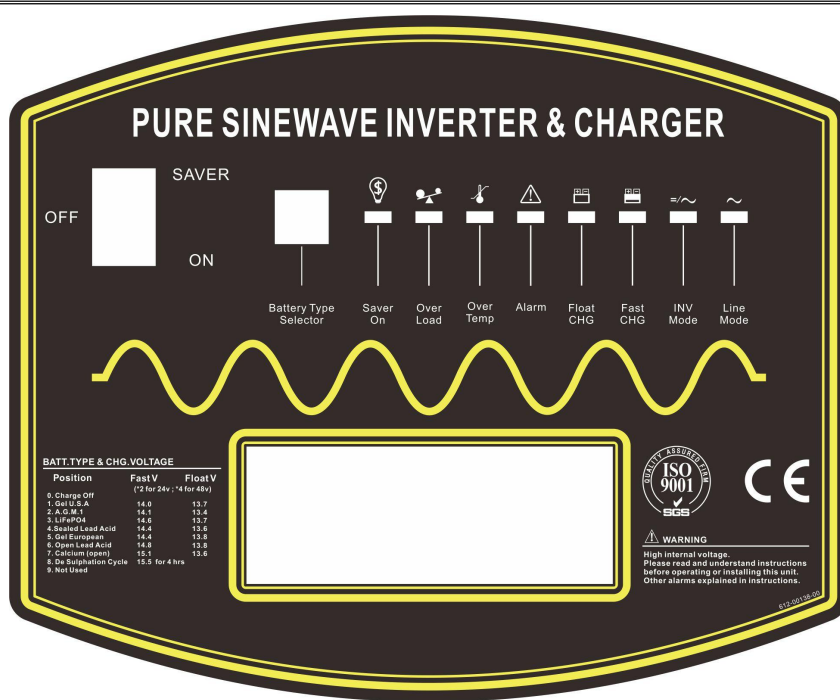

LINE MODE	GREEN LED lit in AC Mode	Please refer to ‘Indicator and Buzzer’ for the detailed information.
INVERTER MODE	GREEN LED lit in Inverter Mode	
FAST CHARGE	YELLOW LED lit in Fast Charging Mode	
FLOAT CHARGE	GREEN LED lit in Float Charging Mode	
ALARM MODE	RED LED lit in Error State	
OVER TEMP TRIP	RED LED lit in Over Temperature	
OVER LOAD TRIP	RED LED lit in Over Load	
POWER SAVER ON	GREEN LED lit in Power Saver Mode	

Table 2.5.8 LF Series LCD Indicators

<p>1 Greeting message</p>	<p>2 AC Status & Input Voltage</p>
<p>3 Output Voltage/Frequency & Battery voltage</p>	<p>4 Output Current / Load(in percentage)</p>

2.5.11 Audible Alarm

Table 2.5.9 LF Series Audible Alarm Spec

Battery Voltage Low	Inverter green LED lit, and the buzzer beeps 0.5s every 5s.
Battery Voltage High	Inverter green LED lit, and the buzzer beeps 0.5s every 1s and Fault after 60s.
Invert Mode Over-Load	(1)110%<load<125%(±10%), No audible alarm in 14 minutes, Beeps 0.5s every 1s in 15 th minute and Fault after 15 minutes; (2)125% <load<150%(±10%), Beeps 0.5s every 1s and Fault after 60s; (3)Load>150%(±10%), Beeps 0.5s every 1s and Fault after 20s;
Over Temperature	Heat-sink temp. ≥105°C, Over temp red LED Lighting, beeps 0.5s every 1s;

2.5.12 FAN Operation

For 1-3KW, there is one multiple controlled DC fan, For 4-6KW, there is two multiple controlled DC fan which starts to work according to the following logic

For 8-12KW, there is two multiple controlled DC fan and one AC fan. The DC fan will work in the same way as the one on 1-3KW, while the AC fan will work once there is AC output from the inverter.

So when the inverter is in power saver mode, the AC fan will work from time to time in response to the pulse sent by the inverter in power saver mode.

The Operation of the DC fan at the DC terminal side is controlled by the following logic

(Refer to Table 2.5.10):

Table 2.5.10 LF Series Fan Operation Logic

Condition	Enter condition	Leave condition	Speed
HEAT SINK TEMPERATURE	$T \leq 60^{\circ}\text{C}$	$T > 65^{\circ}\text{C}$	Off
	$65^{\circ}\text{C} \leq T < 85^{\circ}\text{C}$	$T \leq 60^{\circ}\text{C} / T \geq 85^{\circ}\text{C}$	50%
	$T > 85^{\circ}\text{C}$	$T \leq 80^{\circ}\text{C}$	100%
CHARGER CURRENT	$I \leq 15\%$	$I \geq 20\%$	Off
	$20\% < I \leq 50\%$	$I \leq 15\% / I \geq 50\%$	50%
	$I > 50\%$	$I \leq 40\%$	100%
LOAD% (INV MODE)	Load < 30%	Load ≥ 30%	Off
	$30\% \leq \text{Load} < 50\%$	Load ≤ 20% / Load ≥ 50%	50%
	Load ≥ 50%	Load ≤ 40%	100%

Allow at least 30cm of clearance around the inverter for air flow. Make sure that the air can circulate freely around the unit.

Variable speed fan operation is required in inverter and charge mode. This is to be implemented in such a way as to ensure high reliability and safe unit and component operating temperatures in an operating ambient temperature up to 50°C.

- Speed to be controlled in a smooth manner as a function of internal temperature and/or current.
- Fan should not start/stop suddenly.
- Fan should run at minimum speed needed to cool unit.
- Fan noise level target <60db at a distance of 1m.

2.5.13 DIP Switches

On the front panel of inverter, there are 5 DIP switches which enable users to customize the performance of the device.

Table 2.5.11 LF Series Dip Switch Function Setting

DIP Switch NO.	Switch Function		Position: 0	Position: 1
SW1	Low Battery Trip Volt		10.0Vdc For Deep-Cycle Battery	10.5Vdc For Starting Battery
			*2 for 24Vdc, *4 for 48Vdc	
SW2	AC Input Range / (AVR)	AC Source	For Utility Mode	For Generator Mode
		230Vac HV	184-253Vac / (176-276Vac)	140-270Vac / (150-276Vac)
		120Vac LV	100-135Vac / (92-144Vac)	90-135Vac / (78-144Vac)
SW3	Power Saver Auto Setting		Night Charger Function	Detect Load Per 3Secs
SW4	O/P Frequency Setting		50Hz	60Hz
SW5	Solar/AC Priority Setting		Utility Priority	Battery Priority

SW1: Low Battery Trip Volt:

For 12VDC model, the Low Battery Trip Volt is set at 10.0Vdc by typical deep cycle lead acid battery. It can be customized to 10.5Vdc using SW1 for sealed car battery, this is to prevent batteries from over-discharging while there is only a small load applied on the inverter. (*2 for 24VDC, *4 for 48VDC)

SW2: AC Input Range:

There are different acceptable AC input ranges for different kinds of loads.

For some relatively sensitive electronic devices, a narrow input range of 184-253VAC (100-135V for 120VAC model) is required to protect them.

While for some resistive loads which work in a wide voltage range, the input AC range can be customized to 140-270VAC (90-135V for 120VAC model), this helps to power loads with the most AC input power without frequent switches to the battery bank.

In order to make the inverter accept dirty power from a generator, when the SW2 is switched to position “1”, the inverter will bypass an AC input with a wide voltage and frequency(40Hz-70Hz for 50Hz/60Hz).

Accordingly, the AC charger will also work in a wide voltage and frequency range (43Hz-67Hz for 50Hz/60Hz). This will avoid frequent switches between battery and generator. But some sensitive loads will suffer from the low quality power.

The pros and cons should be clearly realized.

SW3: Power Saver Auto Setting :

In Power Saver Mode, when the SW3 is switched to position “0”, inverter will work in Unit Off Charging mode, it will stay in standby mode without sensing loads. It won’t output any power even if a load is turned on. The inverter will not perform any function and only stay idle in this mode. When a qualified AC input present, it will switch to AC input power to charge the battery and supply the load at the same time.

When the SW3 is switched to position “0”, the inverter is initially in standby mode and sends a pulse to detect the presence of a load every 3 seconds. Each pulse lasts for 250ms. The inverter will remain in standby mode until a load has been detected. Then it will wake up from standby mode and start to inverter electricity from the battery bank to supply the load.

SW4: Frequency Switch:

The output frequency of the inverter can be set at either 50Hz or 60Hz by SW4.

SW5: Solar Mode/AC Mode Priority:

Our inverter is designed with AC priority by default. This means, when AC input is present, the battery will be charged first, and the inverter will transfer the input AC to power the load. Only when the AC input is stable for a continuous period of 15 days, the inverter will start a battery inverting cycle to protect the battery. After 1 normal charging cycle ac through put will be restored.

The AC Priority and Battery Priority switch is SW5. When you choose battery priority, the inverter will inverting from battery despite the AC input. Only when the battery voltage is reaches low voltage alarm point(10.5V for 12V), the inverter transfers to AC Input, charge battery, and switch back to battery when battery is charged full. This function is mainly for wind/solar systems taking utility power as back up.

2.5.14 Output Socket

The inverter is either equipped with a dual GFCI socket (rated at 30Amps) or an universal socket (rated at 10Amps) for more convenient wiring.

2.5.15 Other features**Battery voltage recovery start**

After low battery voltage shut off (10V for 12V model/20V for 24V model/40V for 48V model), the inverter is able to restore operation after the battery voltage recovers to 13Vdc/26Vdc/52Vdc (with power switch still in the “On” position). This function helps to save the users extra labor to reactivate the inverter when the low battery voltage returns to an acceptable range in the renewable energy systems. The built in battery charger will automatically reactivate as soon as city/generator ac has been stable for 15 seconds.

**WARNING**

Never leave the loads unattended, some loads (like a Heater) may cause accident in such cases.

It is better to shut everything down after low voltage trip than to leave your load on, due to the risk of fire.

Auto Generator Start (AGS)

The inverter can be customized to start up a generator when battery voltage goes low.

When the inverter goes to low battery alarm, it can send a signal to start a generator, and turn the generator off after battery charging is finished.

The auto generator start feature will only work with generators designed to work with this feature. There is an open/closed relay that will short circuit the positive and negative cable from a generator. The input DC voltage can vary, but the Max current the relay can carry is 16Amp.

Battery temperature sensor (BTS)

A battery temperature sensor (BTS) option can easily be installed in the system to ensure proper charging of the batteries based on temperature. Installing a BTS extends battery life by preventing overcharging in warm temperatures and undercharging in cold temperatures.

To install the Battery Temperature Sensor:

1. Run the battery temperature sensor wire in the DC conduit (if used) and route the RJ11 connector end to the BATTERY SENSE port located on the front of the inverter.
2. Secure the sensor to one of the batteries located in the center of the battery pack.

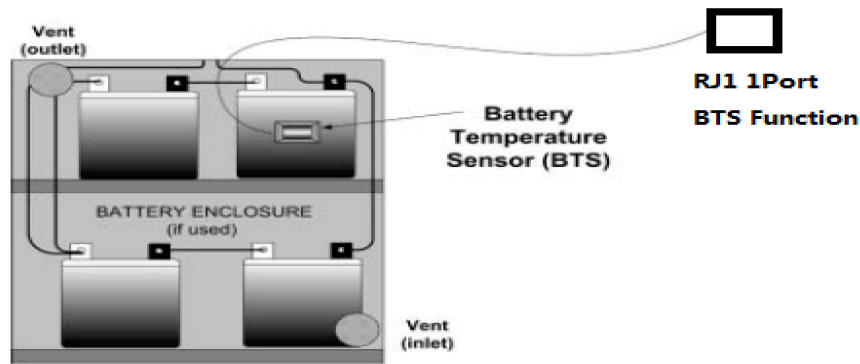

Conformal Coating

Entire line of LF-PV inverters have been processed with a conformal coating on the PCB making it water, rust, and dust resistant.

3 Installation

3.1 Location

Follow all the local regulations to install the inverter.

Please install the equipment in a location that is Dry, Clean, Cool and that has good ventilation.

Working temperature: - 10°C - 40°C

Storage temperature: - 40 - 70°C

Relative Humidity: 0% - 95%, non-condensing

Cooling: Forced air

3.2 DC Wiring recommendation

It is suggested the battery bank be kept as close as possible to the inverter. The following table is a suggested wiring option for 1m DC cable.

Please find the following minimum wire size. In case of DC cable longer than 1m, please increase the cross section of cable to reduce the loss.

Model Watt	Battery Voltage	Wire Gage /Min		Model Watt	Battery Voltage	Wire Gage /Min	
		0~1.0m	1.0~5.0m			0~1.0m	1.0~5.0m
1.000 ~ 1.500	12 Vdc	30mm ²	40mm ²	2.000	12 Vdc	60mm ²	75mm ²
	24 Vdc	15mm ²	20mm ²		24 Vdc	30mm ²	45mm ²
3.000	48 Vdc	10mm ²	15mm ²	4.000	48 Vdc	15mm ²	25mm ²
	12 Vdc	90mm ²	120mm ²		12 Vdc	120mm ²	150mm ²
	24 Vdc	45mm ²	60mm ²		24 Vdc	60mm ²	75mm ²
5.000	48 Vdc	25mm ²	30mm ²	6.000	48 Vdc	30mm ²	40mm ²
	24 Vdc	75mm ²	95mm ²		24 Vdc	90mm ²	120mm ²
8.000	48 Vdc	40mm ²	50mm ²	10.000	48 Vdc	45mm ²	60mm ²
	24 Vdc	120mm ²	150mm ²		10.000	48 Vdc	75mm ²
15.000	48 Vdc	60mm ²	75mm ²	12.000	48 Vdc	90mm ²	120mm ²
	15.000	48 Vdc	120mm ²		150mm ²	18.000	48 Vdc

Please note that if there is a problem obtaining for example 100mm² cable, use 2*50mm² or 3*35mm². One cable is always best, but cable is simply copper and all you require is the copper, so it does not matter if it is one cable or 10 cables as long as the square area adds up. Performance of any product can be improved by thicker cable and shorter runs, so if in doubt round up and keep the length as short as possible.

Battery cables must have crimped (or preferably, soldered and crimped) copper compression lugs unless aluminum mechanical lugs are used. Soldered connections alone are not acceptable. High quality, UL-listed battery cables are available. These cables are color-coded with pressure crimped, sealed ring terminals.

Figure 3.2.1 Battery Cable Connections

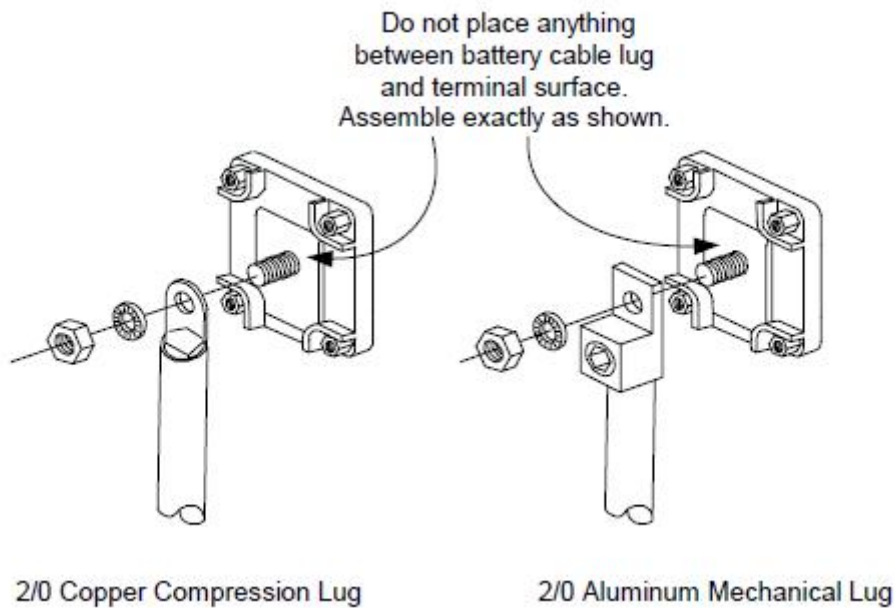

CAUTION: Equipment Damage

The inverter is not reverse polarity protected. Reversing the battery polarity on the DC input connections will cause permanent damage to the inverter which is not covered under warranty. Always check polarity before making connections to the inverter.



WARNING: Shock Hazard

Ensure the inverter is off before disconnecting the battery cables, and that AC power is disconnected from the inverter input.

Battery terminal must be clean to reduce the resistance between the DC terminal and cable connection. A buildup of dirt or oxidation may eventually lead to the cable terminal overheating during periods of high current draw. Use a stiff wire brush and remove all dirt and corrosion from the battery terminals and cables.

3.3 AC Wiring

We recommend using 10-5AWG wire to connect to the AC terminal block.

There are 3 different ways of connecting to the terminal block depending on the model. All the wirings are CE compliant, Call our tech support if you are not sure about how to wire any part of your inverter.

Single-Phase Wiring Mode

230Vac or 120Vac

Input: Hot line+Neutral+Ground

Output: Hot line+Neutral+Ground

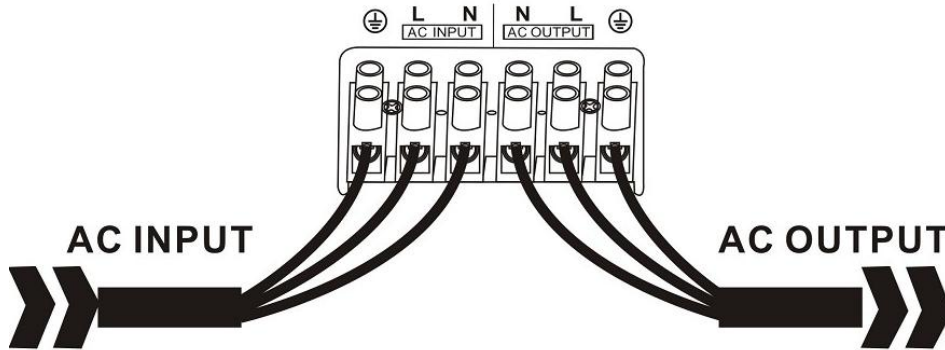

Daul-Phase Wiring Mode

240Vac split phase

Input: Hot line+ Hot line +Ground

Output: Hot line+ Hot line +Neutral

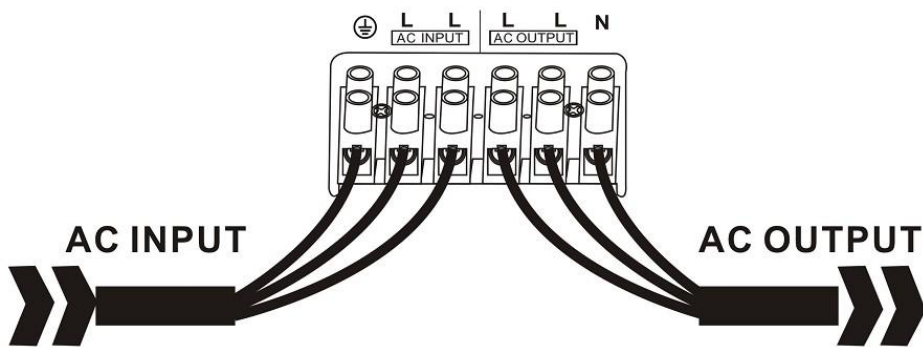

Wiring Option 3

120Vac split phase

Input: Hot line+ Hot line +Ground

Output: Hot line +Neutral+Ground

Remark: In such cases, each output hot line can only carry a half the rated capacity Max.

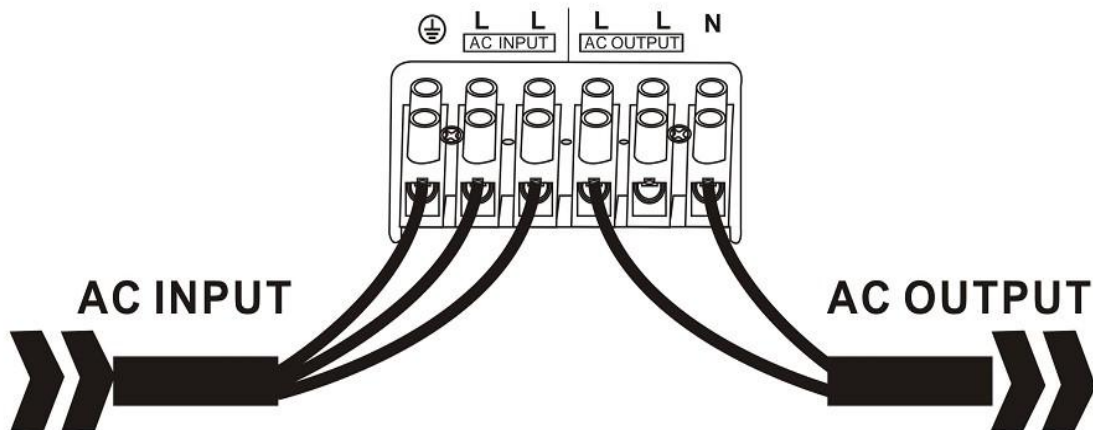
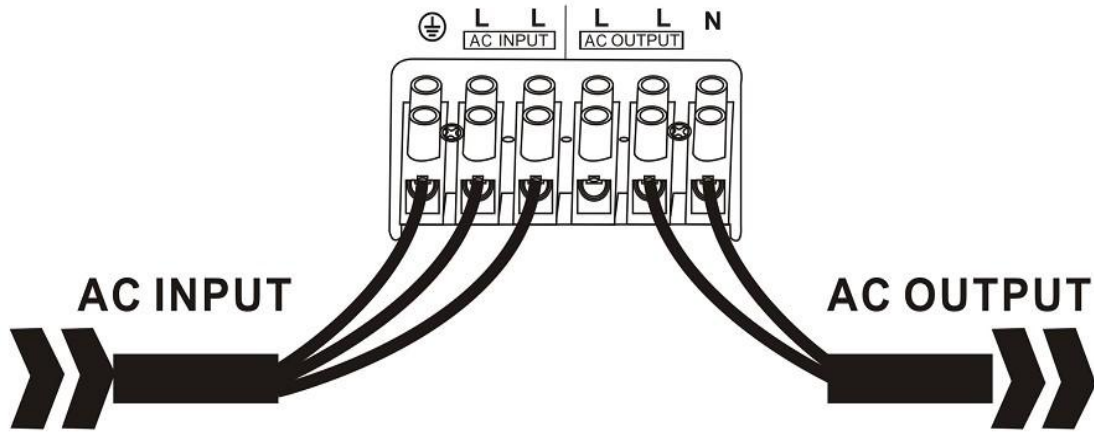

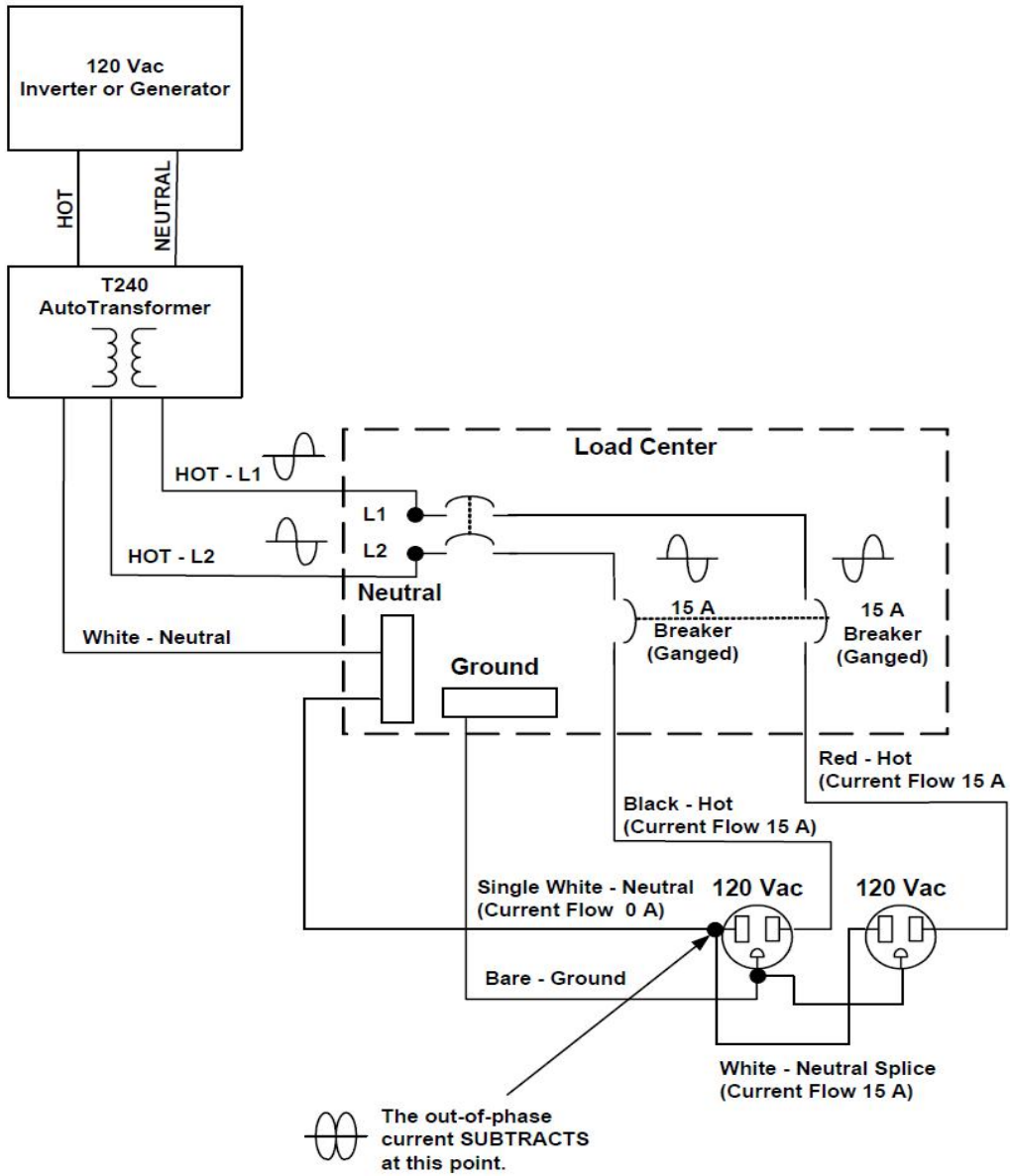

3.4 Install Flange

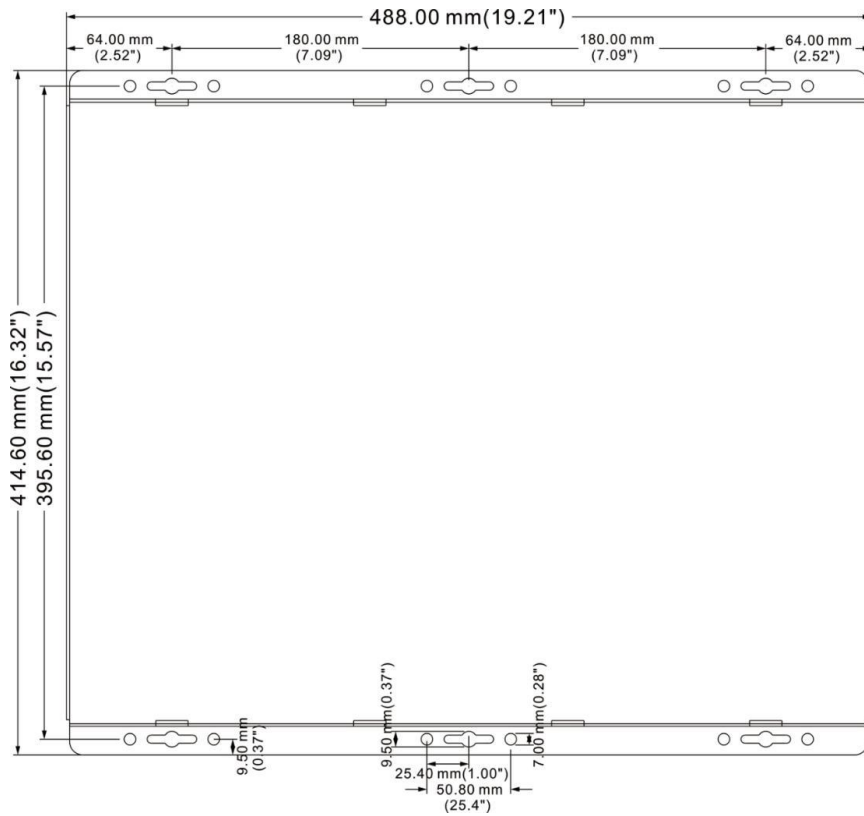

LF 4-6KW Model
LF 1-6KW Model

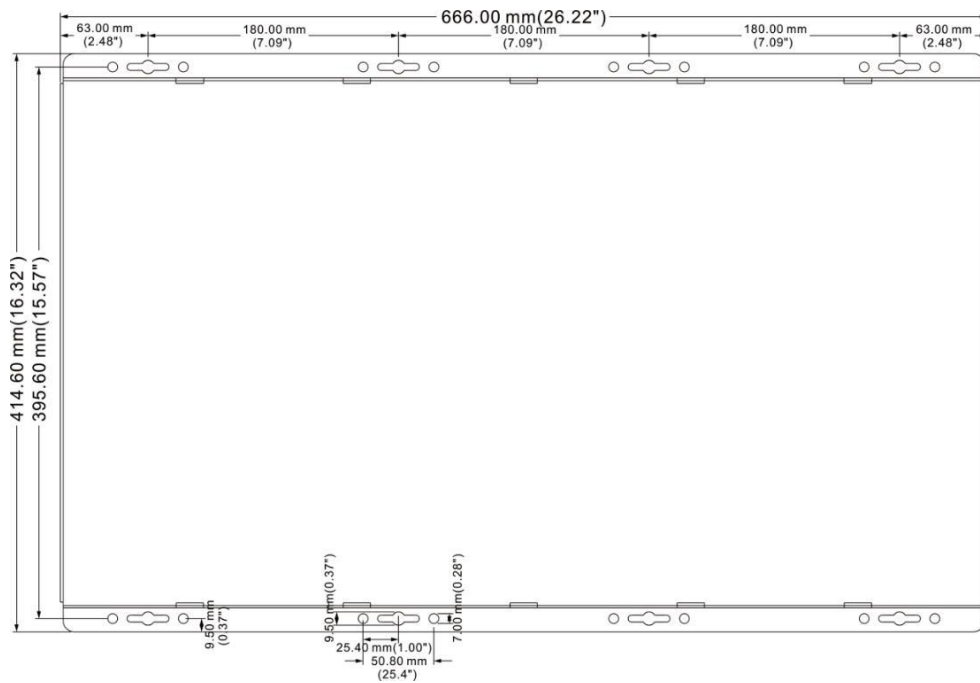

LF 8-12KW Model
LF 8-12KW Model

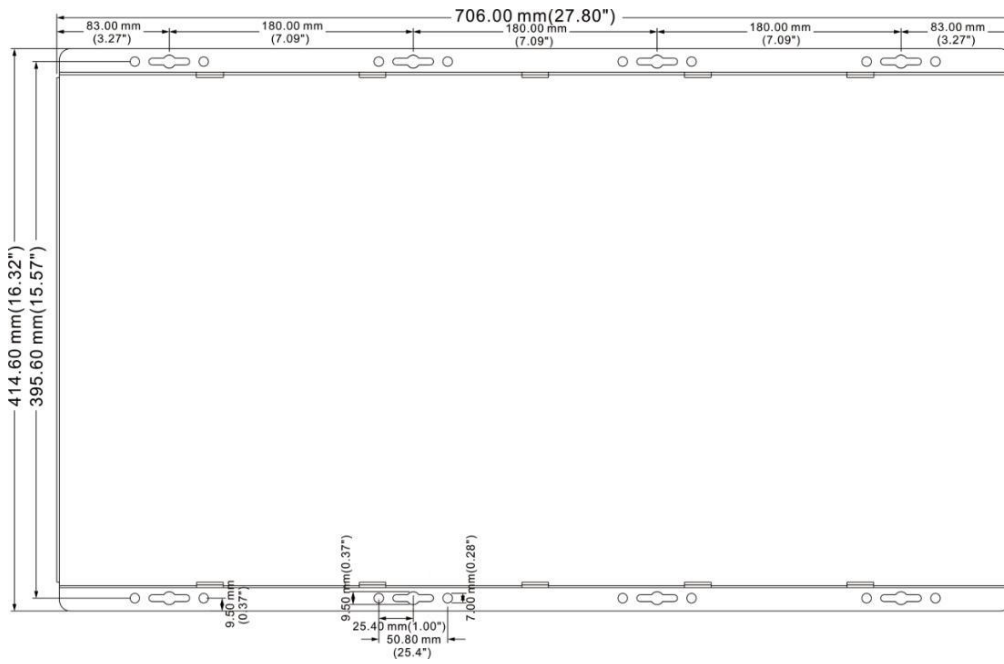

LF 15-18KW Model
LFV 15-18KW Model

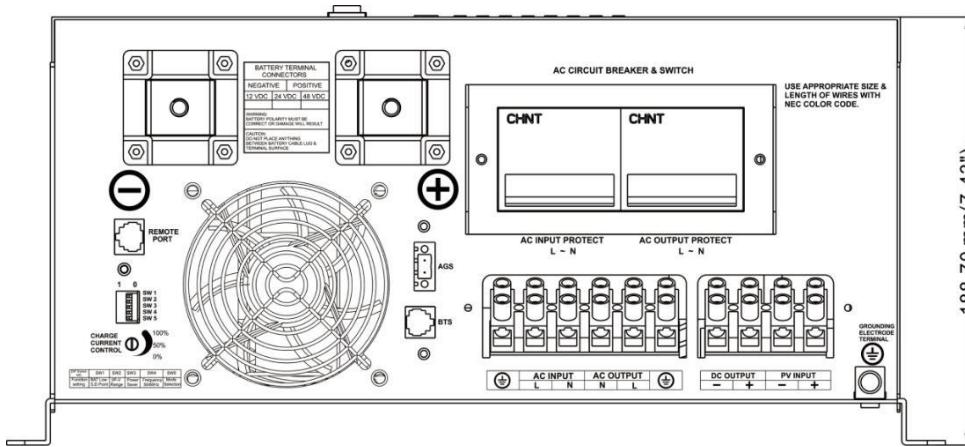

LF 4-12KW Model
LFV 1-12KW Model

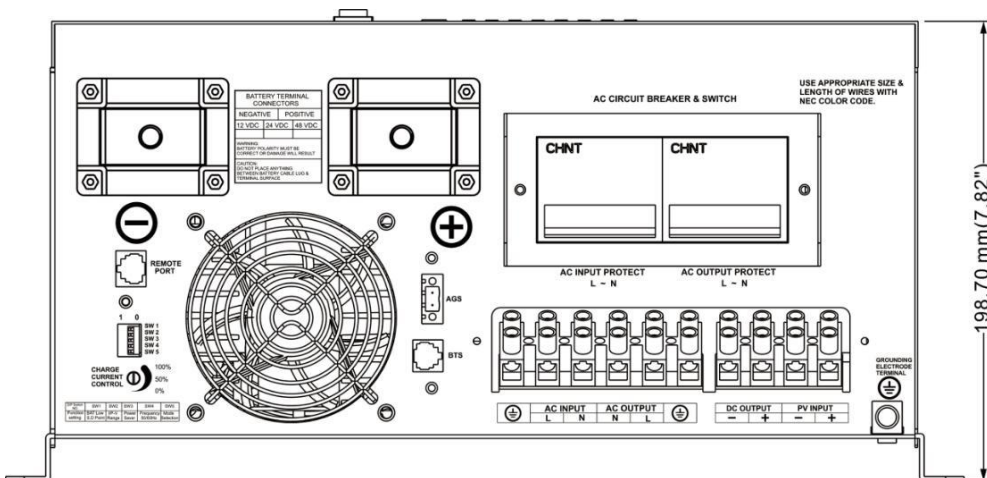

LF 15KW Model
LFV 15KW Model

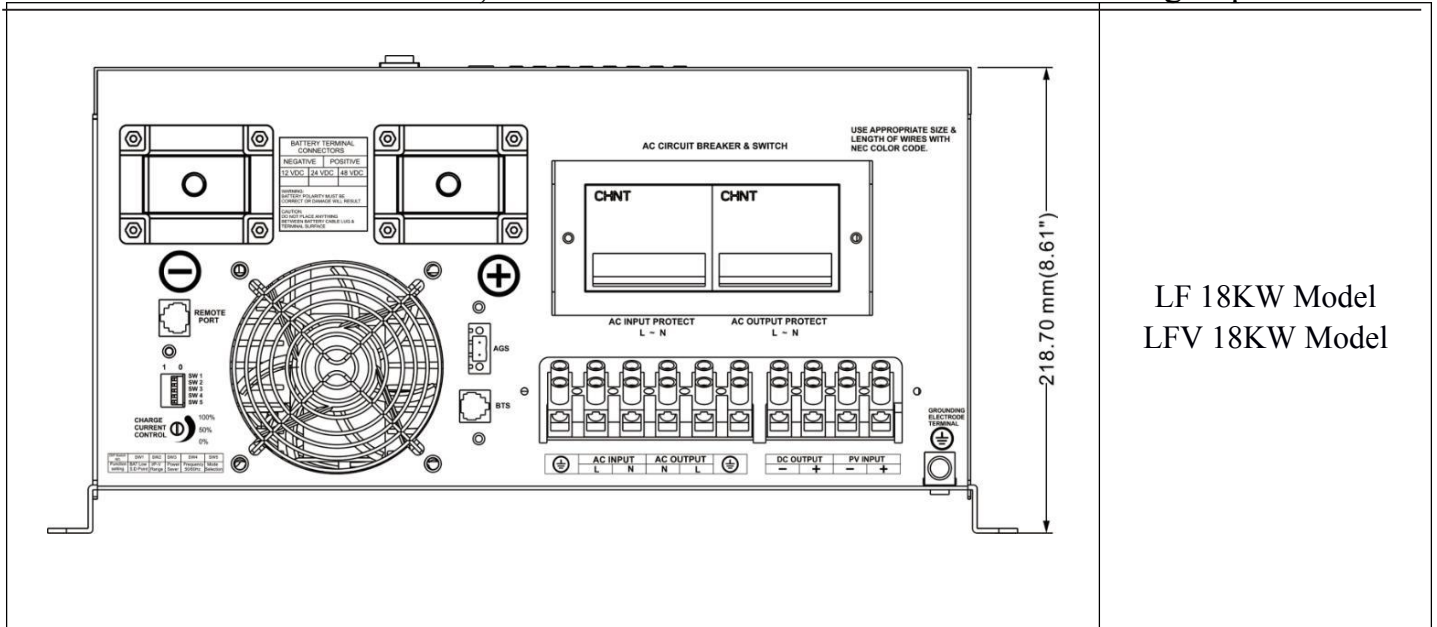

LF 18KW Model
LFV 18KW Model

4 Battery Information

4.1 Battery Type

There are two principal types of batteries: Starting type and Deep-Discharge type. Batteries can be either sealed or non-sealed(Vented).

A. Starting type: Automotive(Starting type) batteries are designed to provide high starting current for short periods of time and are not appropriate for solar system.

B. Deep-Discharge type: The battery types recommended for use in the inverter system are Flooded Lead Acid

- * Sealed construction, safety and no leakage
- * Maintenance-free, convenient for installation
- * Broad operating temperature range
- * High capacity, high energy density
- * Long service life, Excellent recharge and discharge performance
- * Low self-discharge rate, more deep cycle times

4.2 Battery Capacity Rating

4.2.1 Battery Discharge Rate

Deep cycle batteries have their amp-hour rating expressed as “at the x-hour rate”.

The hour rating refers to the time it takes to discharge the batteries. A faster hour rate (10 hour rate) means more current is withdrawn from the batteries during their discharge period. There is an inevitable amount of heat associated with the flow of current through a battery and the higher amount of current the greater the amount of heat will be generated. The heat is energy which is no longer available to the battery to power loads. a relatively long discharge rate (120 hour rate) will result in a larger number of amp-hours being available for electrical loads.

4.2.2 Depth of Discharge

The battery bank's size determines the length of time the inverter can supply AC output power. The larger the bank, the longer the inverter can run.

In general, the battery bank should be designed so the batteries do not discharge more than 60% of their capacity on a regular basis. Discharging up to 80% is acceptable on a limited basis, such as a prolonged utility outage. Totally discharging a battery can reduce its effective life or permanently damage it.

4.2.3 Understanding Amp-Hour Requirements

To estimate the battery bank requirements, you must first calculate the amount of power you will draw from the batteries during your period of autonomy. This power draw is then translated into Amp-Hours (Ah) the unit of measure to express deep-cycle battery capacity.

Amp Hours are calculated multiplying the current drawn by the load by the length of time it will operate.

To calculate amps when the power consumption is expressed in watts, use the following equation:

$$A = P/V$$

P = Watts ; V = Volts DC ;

For example:

A 60 watt light bulb will draw approximately 5.0 Amps.

$$5.0 = 60 / 12$$

If the light runs for three hours it will consume (5.0 x 3) or 15 Ah of power.

The length of time a load is operated will affect the power draw. In some cases, an appliance which draws a large wattage may not consume as many amp hours as a load drawing fewer watts but running for a longer period of time.

For Example:

A circular saw draws 1500 watts or 125 amps. It takes 5 seconds to complete a cross cut. Twelve such cuts would take a minute and you would consume 125A x 0.016* hour = 2 Ah. (*0.016 = 1/60)

Suggestion :

All electrical appliances have labels which state their energy consumption. Look for an amps rating on motors and a watts rating on other appliances. If the label plate has expressed power consumption in amps, multiply by volts for the watts required. (watts = volts x amps).

When calculating battery bank size, consider the following:

Motors typically require 3 to 6 times their running current when starting. Check the manufacturer's data sheets for their starting current requirements. If you will be starting large motors from the inverter, increase the battery bank size to allow for the higher start-up current.

4.2.4 Battery Configurations

The battery bank must be wired to match the inverter's DC input voltage specifications (12 or 24 or 48Vdc). In addition, the batteries can be wired to provide additional run time.

Series: Wiring batteries in series increases the total bank output voltage. This voltage MUST match the DC requirements of the inverter or inverter and/or battery damage may occur.

Parallel: Wiring the batteries in parallel increases the total run time the batteries can operate the AC loads. The more batteries connected in parallel the longer the loads can be powered from the inverter.

Series-Parallel: Series-parallel configurations increase both the battery voltage (to match the inverter's DC requirements) and run-time for operating the AC loads. This voltage must match the DC requirements of the inverter.

Batteries with more than two or three series strings in parallel often exhibit poor performance characteristics and shortened life.

Table 4.2.3 Battery Wiring In Series-Parallel Configuration

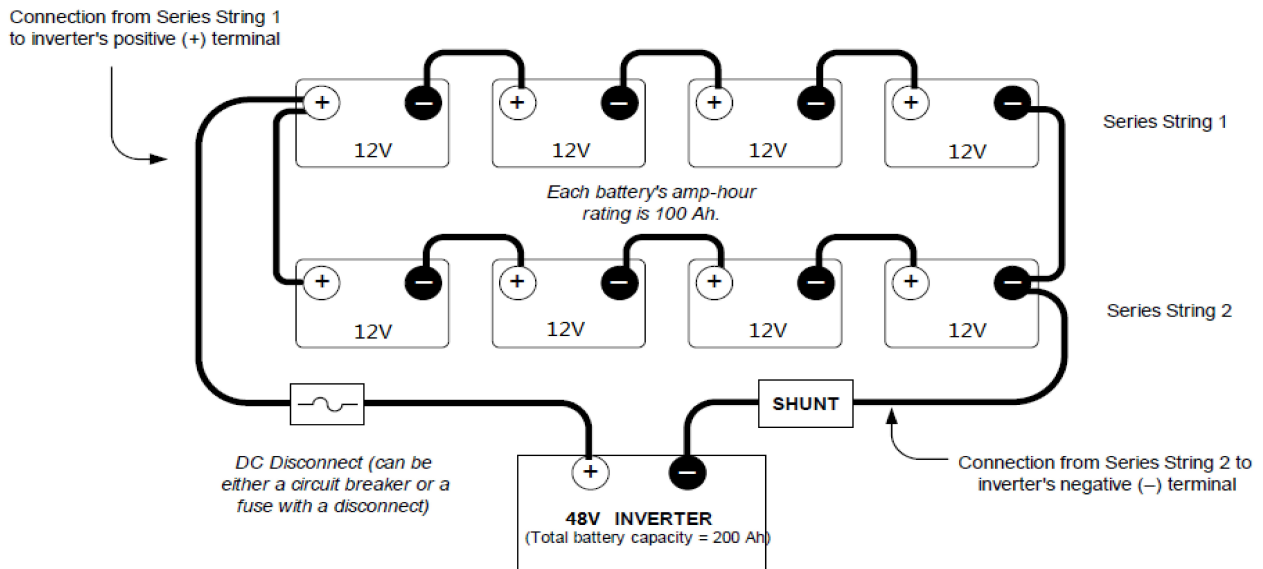

Important: Connecting the positive and negative wires to the inverter from different strings ensures a balanced charge/discharge through the batteries, resulting in longer run times and improved battery life.

4.2.6 Batteries Maintenance

To get the best performance from an inverter system, the batteries must be properly setup and maintained. This includes setting the proper voltages for Bulk and Float charging. See the “CAUTIONS” in the section on Equalization Charging that follows. In addition, the battery terminals should be inspected, cleaned, and re-torqued if necessary.

Battery posts must be clean to reduce the resistance between the battery post and cable connection. A buildup of dirt or oxidation may eventually lead to the cable terminal overheating during periods of high current draw.

Use a stiff wire brush and remove all dirt and corrosion from the battery terminals and cables. Use an alkaline solution of baking soda and water to clean the terminals and neutralize any battery acid on the terminals or cable lugs.

Charge Rate

The maximum safe charge rate is related to the size and type of the batteries. Flooded lead acid batteries (with removable caps) can be charged at a high rate. Small batteries may require a lower charge rate. Check with your battery vendor for the proper battery charging rate for the batteries used in the system.

Bulk Voltage

This is the maximum voltage the batteries will be charged to during a normal charge cycle. Gel cell batteries are set to a lower value and non-sealed batteries are set to a higher voltage setting.

Float Voltage

The Float voltage is set lower than the Bulk voltage and provides a maintenance charge on the batteries to keep them in a ready state.

Temperature Compensation

For optimal battery charging, the Bulk and Float charge rates should be adjusted according to the temperature of the battery. This can be accomplished automatically by using a BTS. The sensor attaches directly to the side of one of the batteries in the bank and provides precise battery temperature information. When battery charging voltages are compensated based on temperature, the charge voltage will vary

depending on the temperature around the batteries. The following table describes approximately how much the voltage may vary depending on the temperature of the batteries.

If you have liquid lead acid batteries (non-sealed), you may need to periodically equalize your batteries. Check the water level monthly to maintain it at the appropriate level.

Important: If the battery temperature is allowed to fall to extremely cold temperatures, the inverter with a BTS may not be able to properly recharge cold batteries due to maximum voltage limits of the inverter. Ensure the batteries are protected from extreme temperatures.

5 Troubleshooting Guide

Troubleshooting contains information about how to troubleshoot possible error conditions while using the LF Series Inverter & Charger.

The following chart is designed to help you quickly pinpoint the most common inverter failures.

Indicator and Buzzer

Status	Item	Indicator On Front Panel								Indicator On Remote Module			Buzzer
		Utility Power On	Inverter On	Fast Charge	Float Charge	Alarm	Over-Temp Trip	Over-Load Trip	Power Save On	CHARGER ON	INVERTER ON	ALARM	
Line Mode	C.C	√	×	√	×	×	×	×	×	√	×	×	×
	C.V	√	×	√, Blink	×	×	×	×	×	√	×	×	×
	Float	√	×	×	√	×	×	×	×	√	×	×	×
	Standby	√	×	×	×	×	×	×	×	×	×	×	×
Inv Mode	Inverter On	×	√	×	×	×	×	×	×	×	√	×	×
	Power Saver	×	×	×	×	×	×	×	√	×	×	×	×
Inv Mode	Battery Low	×	√	×	×	√	×	×	×	×	√	√	Beep 0.5s every 5s
	Battery High	×	√	×	×	√	×	×	×	×	√	√	Beep 0.5s every 1s
	Overload On Inverter Mode	×	√	×	×	√	×	√	×	×	√	√	Refer to “Audible alarm”
	Over-Temp On Inverter Mode	×	√	×	×	√	√	×	×	×	√	√	Beep 0.5s every 1s
	Over-Temp On Line Mode	√	×	√	×	√	√	×	×	√	×	√	Beep 0.5s every 1s
	Over Charge	√	×	√	×	√	×	×	×	√	×	√	Beep 0.5s every 1s
Fault Mode	Fan Lock	×	×	×	×	×	×	×	×	×	×	×	Beep continuous
	Battery High	×	√	×	×	×	×	×	×	×	√	×	Beep continuous
	Inverter Mode Overload	×	×	×	×	×	×	√	×	×	×	×	Beep continuous
	Output Short	×	×	×	×	√	×	√	×	×	×	√	Beep continuous
	Over-Temp	×	×	×	×	×	√	×	×	×	×	×	Beep continuous
Fault Mode	Over Charge	×	×	√	×	×	×	×	×	√	×	×	Beep continuous
	Back Feed Short	×	×	×	×	×	×	×	×	×	×	×	Beep continuous

Symptom	Possible Cause	Recommended Solution
Inverter will not turn on during initial power up.	Batteries are not connected, loose battery-side connections. Low battery voltage.	Check the batteries and cable connections. Check DC fuse and breaker. Charge the battery.
No AC output voltage and no indicator lights ON.	Inverter has been manually transitioned to OFF mode.	Press the switch to Power saver on or Power saver off position.
AC output voltage is low and the inverter turns loads OFF in a short time.	Low battery.	Check the condition of the batteries and recharge if possible.
Charger is inoperative and unit will not accept AC.	AC voltage has dropped out-of-tolerance	Check the AC voltage for proper voltage and frequency.
Charger is supplying a lower charge rate.	Charger controls are improperly set. Low AC input voltage. Loose battery or AC input connections.	Refer to the section on adjusting the "Charger Rate". Source qualified AC power.. Check all DC /AC connections.
Charger turns OFF while charging from a generator.	High AC input voltages from the generator.	Load the generator down with a heavy load. Turn the generator output voltage down.
Sensitive loads turn off temporarily when transferring between grid and inverting.	Inverter's Low voltage trip voltage may be too low to sustain certain loads.	Choose narrow AC voltage in the DIP switch, or Install a UPS if possible.
Noise from Transformer/case*	Applying specific loads such as hair drier	Remove the loads

***The reason for the noise from transformer and/or case**

When in inverter mode sometimes the transformer and/or case of the inverter may vibrate and make noise.

If the noise comes from transformer:

According to the characteristics of our inverter, mainly there is one type of load which most likely may cause rattles of transformer.

That is half wave load: A load that uses only half cycle of the power (see figure 1). This tends to cause an imbalance of the magnetic field of the transformer, reducing its rated working freq from 20KHz to maybe 15KHz (it varies according to different loads). In such a case the frequency of noise falls exactly into the range (200Hz-20KHz) that human ears can hear.

The most common load of such kind is a hair drier.

If the noise comes from the case:

Normally when loaded with inductive loads, the magnetic field generated by the transformer keeps attracting or releasing the steel case at a specific freq, this may also cause noise.

Reducing the load power or using an inverter with bigger capacity will normally solve this problem.

The noise will not do any harm to the inverter or the loads.

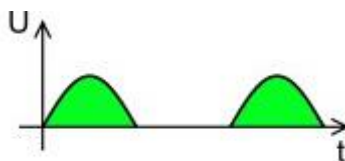

Figure 1 Half Cycle Load Waveform

6 Warranty

We offer a 1 year limited warranty.

The following cases are not covered under warranty.

1 DC polarity reverse.

The inverter is designed without DC polarity reverse protection. A polarity reverse may severely damage the inverter.

2 Wrong AC wiring

3 Operating in a wet environment.

4 Operating with an undersized generator or generator with unqualified wave form.

7 Ordering Information

Model Identification and Numbering Conventions

The LF Inverter is identified by the model/serial number labels. The Serial Number can be located on the mounting rail or inside the top cover. Model Number labels may be located on the bottom side of the front cover or possibly inside the front cover. All the necessary information is provided on the label such as AC output voltage, power and frequency (punch holes).

The inverter also has a letter designator followed by 4-6 digits (depending on revision). The model number describes the type of inverter, the output specifications, the required battery voltage and the output voltage and frequency.

Typical Part Number	HP Basic Series	20 Power Rating	12 Battery Voltage	E Output Voltage
1. Basic Series HP: Inverter & Charger HP-PV: Inverter & Charger & Solar Controller				
2. Power Rating 10=1000W 15=1500W 20=2000W 30=3000W 40=4000W 50=5000W 60=6000W 80=8000W 100=10KW 120=12KW				
3. Battery Voltage 12=12VDC 24=24VDC 48=48VDC				
4. Output Voltage No Letter=LV120VAC E=HV230VAC D=120/230VAC				

Figure 6-1 Product Identification

Appendix 1

Electrical Specifications														
	Model	1.0KW	1.5KW	2.0KW	3.0KW	4.0KW	5.0KW	6.0KW	8.0KW	10.0KW	12.0KW	15.0KW	18.0KW	
Inverter Output	Continuous Output Power	1.0KW	1.5KW	2.0KW	3.0KW	4.0KW	5.0KW	6.0KW	8.0KW	10.0KW	12.0KW	15.0KW	18.0KW	
	Surge Rating(20Secs)	3.0KW	4.5KW	6.0KW	9.0KW	12.0KW	15.0KW	18.0KW	24.0KW	30.0KW	36.0KW	45.0KW	54.0KW	
	Output Waveform	Pure Sine wave/Same as input(Bypass Mode)												
	Nominal Efficiency	>88%(Peak)												
	Line Mode Efficiency	>95%												
	Power Factor	0.9-1.0												
	Nominal Output Voltage rms	100-110-120Vac / 220-230-240Vac												
	Output Voltage Regulation	±10% RMS												
	Output Frequency	50Hz ± 0.3Hz/60Hz ± 0.3Hz												
	Short Circuit Protection	Yes(1sec after fault)												
	Typical transfer Time	10ms(Max)												
	THD	< 10%												
DC Input	Nominal Input Voltage	12.0Vdc / 24.0Vdc / 48.0Vdc					24.0Vdc / 48.0Vdc			48.0Vdc				
	Minimum Start Voltage	10.0Vdc / 10.5Vdc for 12Vdc Mode					*2 for 24Vdc, *4 for 48Vdc;							
	Low Battery Alarm	10.5Vdc / 11.0Vdc for 12Vdc Mode												
	Low Battery Trip	10.0Vdc / 10.5Vdc for 12Vdc Mode												
	High Voltage Alarm	16.0Vdc for 12Vdc Mode												
	Low Battery voltage recover	15.5Vdc for 12Vdc Mode												
	Idle Consumption-Search Mode	< 25 W when Power Saver On.(Refer to Table)												
Charger	Output Voltage	Depends on battery type (Refer to Table 2.5.2)												
	Charger Breaker Rating	20A	20A	20A	25A	32A	40A	40A	50A	80A	80A	100A	100A	
	Max Charge Power Rate	1/3 Rating Power (Refer to Table 2.5.3)												
	Battery Initial Voltage for Start	10-15.7Vdc for 12Vdc Mode					*2 for 24Vdc, *4 for 48Vdc;							
	Over Charge Protection S.D.	15.7Vdc for 12Vdc Mode												
BTS	Battery Temperature Sensor (Optional)	Yes(Refer to the table) Variances in Charging Voltage & S.D Voltage Base on the Battery Temperature.												
Bypass & Protection	Input Voltage Waveform	Sine wave (Grid or Generator)												
	Nominal Voltage	100-110-120Vac / 220-230-240Vac												

	Max Input AC Voltage	150VAC For 120Vac LV Mode; 300VAC For 230Vac HV Mode;											
	Nominal Input Frequency	50Hz or 60Hz											
	Low Freq Trip	47±0.3Hz for 50Hz, 57±0.3Hz for 60Hz											
	High Freq Trip	55±0.3Hz for 50Hz, 65±0.3Hz for 60Hz											
	Overload protection(SMPS load)	Circuit Breaker											
	Output Short circuit protection	Circuit Breaker											
	Bypass breaker rating	20A	20A	20A	25A	32A	40A	40A	50A	80A	80A	100A	100A
	Transfer switch rating	30Amp for UL & TUV				40Amp for UL			80Amp for UL			100Amp for UL	
	Bypass without battery connected	Yes (Optional)											
	Max bypass current	30Amp				40Amp			80Amp			80Amp	
Solar Charger (Optional)	Rated Voltage	12Vdc / 24Vdc / 48Vdc											
	Solar Input Voltage Range	15-145Vdc / 30-145Vdc / 60-145Vdc											
	Rated Charge Current	80A											
	Rated Output Current	15A											
	Self Consumption	< 10mA											
	Bulk Charge(Default)	14.5Vdc for 12Vdc Mode					(*2 for 24Vdc, *4 for 48Vdc)						
	Floating Charge(Default)	13.5Vdc for 12Vdc Mode											
	Equalization Charge(Default)	14.0Vdc for 12Vdc Mode											
	Over Charge Disconnection	14.8Vdc for 12Vdc Mode											
	Over Charge Recovery	13.6Vdc for 12Vdc Mode											
	Over Discharge Disconnection	10.8Vdc for 12Vdc Mode											
	Over Discharge Reconnection	12.3Vdc for 12Vdc Mode											
	Temperature Compensation	- 13.2mV/°C for 12Vdc Mode											
Ambient Temperature	0 ~ 40°C (Full load) 40 ~ 60°C (Derating)												
Mechanical Specifications	Mounting	Wall Mount											
	Inverter Dimensions(L*W*H)	388*415*200mm				488*415*200mm			666*415*200mm			706*415*230mm	
	Inverter Weight(Solar Chg)KG	21+2.5	22+2.5	23+2.5	27+2.5	38+2.5	48+2.5	49+2.5	60+2.5	66+2.5	70+2.5	75+2.5	78+2.5
	Shipping Dimensions(L*W*H)	550*520*310mm				650*520*310mm			828*520*310mm			868*520*350mm	
	Shipping Weight(Solar Chg)KG	23+2.5	24+2.5	25+2.5	29+2.5	40+2.5	50+2.5	51+2.5	62+2.5	68+2.5	72+2.5	78+2.5	81+2.5
	Display	Status LEDs / Status LEDs+LCD											
	Standard Warranty	1 Years											

Appendix 2 Battery Temperature Compensation (BTS)

Condition	INV/CHG Status	Transfer Point
Charger Mode	CHG On >>>CHG Off	BTS ≥ 50°C
	CHG Off >>> CHG On	BTS ≤ 40°C
Inverter Mode	S.D Point + 0.5Vdc	40°C ≤ BTS ≤ 50°C
	Over Temp Fault	BTS ≥ 50°C

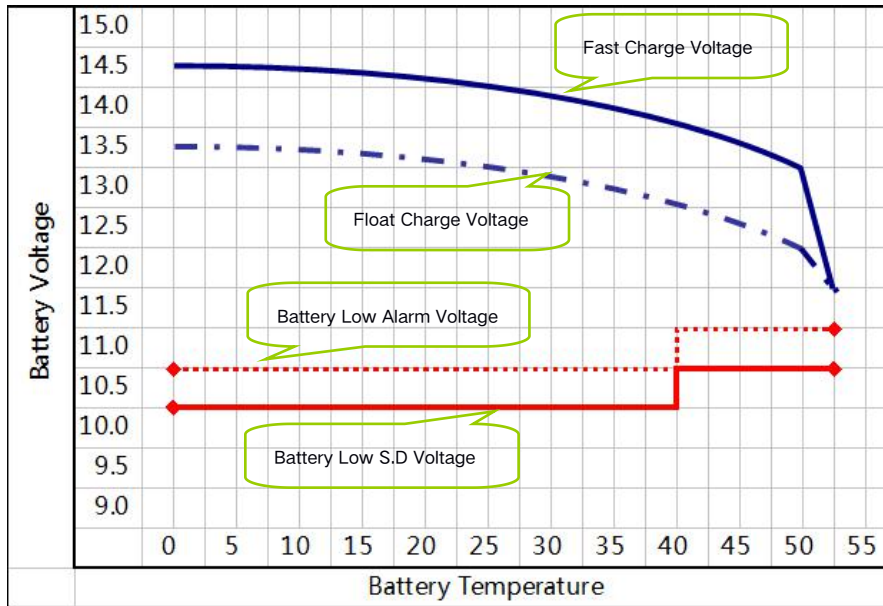

Default output voltage for Float and Absorption are at 25°C.

Reduce Float voltage follows Float voltage and Raised Absorption voltage follows Absorption voltage.

In a adjust mode temperature compensation does not apply.

Note: Specifications subject to change without notice.

Important: The battery charger control circuit operates from the battery voltage. If the battery voltage falls below 7 Volts, the inverter/charger will not operate. The battery must first be recharged using a stand-alone charger to bring the voltage up to a level where the inverter/charger can operate.

MPPT Solar Charge Controller

SGC481585A/SGC4815100A/SGC482585A/SGC4825100A

User Manual

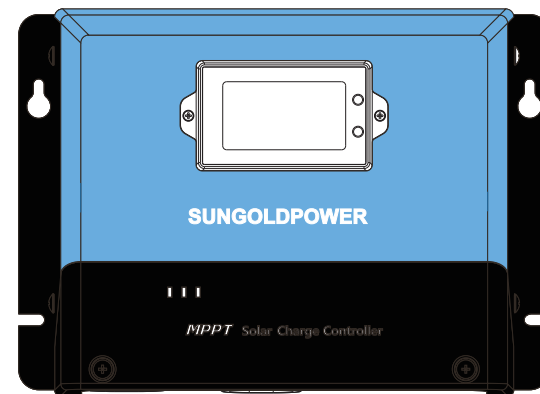

Dear Users:

Thank you for choosing our products!

Safety Instruction

- 1) The applicable voltage of the controller is beyond safety voltage of personnel. Before operation, please read the instruction manual carefully and start operating only after receiving safe operation training.
- 2) There is no parts requiring repair or maintenance within the controller, so please don't disassemble or repair the controller without authorization.
- 3) Please install the controller indoors and prevent water against entering into the controller.
- 4) Please install the controller in a well-ventilated place and the cooling fans in operation have high temperature.
- 5) It is suggested to install a suitable fuse or breaker outside of the controller.
- 6) Before installing and adjust the controller wiring, please break the connecting wire of the solar panel battery and the fuse or breaker close to the battery terminal.
- 7) After installation, inspect whether all wires are connected firmly to avoid any hazard caused by accumulated heat owing to poor contact.



Warning:

Indicating that the operation is hazardous, please fully prepared for safety before operation.



Notice:

Indicating that the operation is destructive.

Tips:

Our main sales MPPT controller product model is SGC4825100A, please note the content of the parameters in the user manual when you use.

Table of Contents

1, Introduction to Product	03
1.1, Product Overview	03
1.2, Product Characteristics	03
1.3, Description of Appearance and Interface	04
1.4, System Wiring Schematic Diagram	05
1.5, Introduction to Maximal Power Tracking Technology	06
1.6, Introduction to Charging Stage (MPPT, Constant Voltage and Current)	06
2, Technical Parameter	08
2.1, Electrical parameter	08
2.2, Battery Type Parameter by Default	09
3, State instruction for indicator light	09
3.1, Charge state indication	09
3.2, State Display of Battery	10
3.3, Type Indication of Battery	10
4, Key	10
4.1, Key function I: set battery type	10
4.2, Key function II: recover factory default parameter	10
5, Parameter Setting and Special Function Use	11
5.1, Monitoring Use of Mobile Phone APP (Standard Configuration)	11
5.2, Application of Lead Acid Battery	11
5.3, Application of Lithium Battery	11
5.4, Setting of Charging Current	11
5.5, Definition of RS485 Communication Interface	12
5.5.1, Set as communication mode	12
5.5.2, Set as parallel operation mode	12
5.5.3, Remote on/off of charger	12
5.6, TTL Communication	12
5.7, Temperature Sampling of Battery	12
5.8, Voltage Compensation Wire of Battery	13
5.9, Programmable Relay Output	13
5.10, Use of Parallel Operation Function	13
6, Liquid Crystal Display	14
6.1, Menu Schematic Diagram	14
6.2, Menu Browse	15
6.3, Set System Parameter via LCD	15
6.4, Abnormal Code Display	16
6.5, Common Problem and Treatment Method	17
6.6, Installation Size of LCD	17
7, Product Installation	18
7.1, Installation Notice	18
7.2, Wiring Specification	18
7.3, Installation and Wiring	18
8, Protection Function	20
8.1, Introduction to Protection Function	20
9, System Maintenance	21
10, Product Dimension	21
11, Solar Controller : Solar APP	23

1. Introduction to Product

1.1 Product Overview

The controller adopts the leading PowerCatcher maximal power Tracking technology in the industry to achieve maximal energy Tracking for solar panel, so that it can quickly and accurately trace the maximal power point of the solar battery, acquire the maximal energy of the solar panel and significantly improve the energy utilization ratio of the solar system. Widely applied to solar off-line photovoltaic system for managing solar panel and storage battery in operation, the controller is the core control component of off-line photovoltaic system.

The inside of the controller possesses sound electronic failure detecting and protection function to avoid the product component damage caused by installation error and system failure.

The controller is equipped with an LCD display screen to simultaneously support data interaction, setting and other operations with mobile phone APP, PC upper computer and other devices.

1.2 Product Characteristics

- ◆ PowerCatcher maximal power Tracking technology can still trace the maximal power point of solar battery in the complicated environment. Compared with traditional MPPT Tracking technology, it enjoys higher response speed and higher Tracking efficiency.
- ◆ MPPT charge efficiency is greater than traditional PWM charge efficiency by about 15% ~20%.
- ◆ MPPT Tracking efficiency can be as much as 99.9%.
- ◆ Adopting advanced digital power technology, the circuit energy conversion efficiency can be as much as 98%.
- ◆ The products support lithium batteries, charging output has active voltage stabilization function. In case of open circuit of lithium batteries or BMS overcharging protection, the storage battery end of the controller shall output stable target voltages in time, thereby possessing good lithium electric activation function.
- ◆ Preset a variety of battery types: lithium batteries, sealed batteries, colloidal batteries, open batteries and self-definition.
- ◆ Lead-acid batteries support temperature compensation function.
- ◆ With charging line loss compensation, the voltage of the battery terminal can be accurately controlled.
- ◆ With current-limiting charging, in case of too much battery panel power (charging current is greater than rated current), the controller automatically reduces the charging power so that it can operate within the rated charging current.
- ◆ With built-in overtemperature protection mechanism, when the temperature exceeds the set temperature value, the charging power shall decline in a linear way with the temperature.
- ◆ It supports parallel function and breaks through the power limit of single unit. Therefore, combination of several units can meet greater charging power.
- ◆ With built-in bluetooth 4.0BLE module, it can achieve mobilephone APP data interaction.
- ◆ Supporting standard Modbus protocol, it provides protocol technology support to facilitate secondary development and application by users.
- ◆ Programmable relay output

1.3 Description of Appearance and Interface

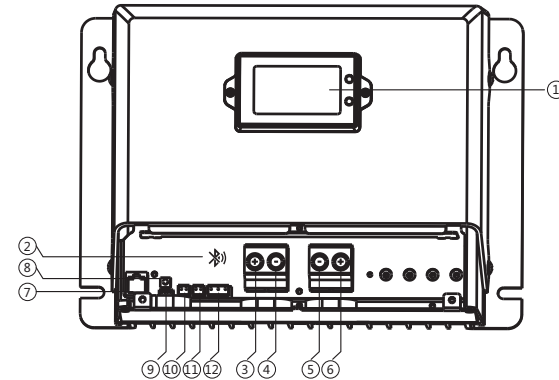

No.	Name	No.	Name
①	Liquid crystal display (LCD)	⑦	RS485 communication interface
②	Bluetooth 4.0BLE module	⑧	Key
③	Positive interface of battery	⑨	TTL communication interface
④	Negative interface of battery	⑩	Battery temperature sampling interface
⑤	Negative interface of solar panel	⑪	Battery voltage sampling interface
⑥	Positive interface of solar panel	⑫	Relay output interface

Note: Negative poles of storage battery and solar battery are a common negative pole design.

1.4 System Wiring Schematic Diagram

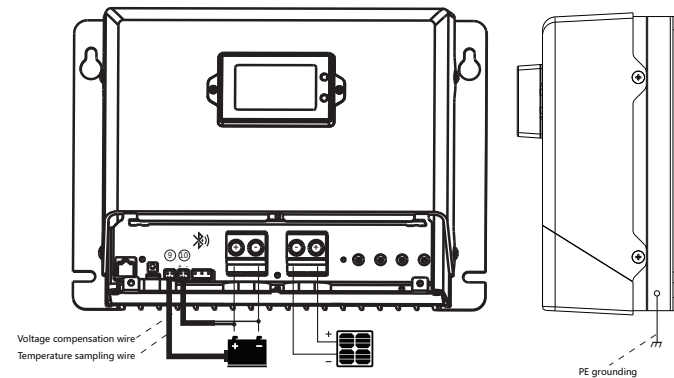

1.5 Introduction to Maximal Power Tracking Technology

Maximal power point tracing system is an advanced charge technology where the operation state of the electric module is adjusted so that the solar battery can output more electric energy. Owing to the nonlinear characteristics of solar battery array, there is an array of maximal energy output point (maximal power point), the traditional controller (on-off charging technology and PWM charging technology) cannot maintain storage battery charging at this point. Therefore, it is unable to acquire the maximal energy of battery panel. However, the solar controller with MPPT control technology can trace the maximal power point of the array to acquire the maximal energy to charge the storage battery.

Taking 12V system as the example, the peak voltage (V_{pp}) of solar battery is about 17V, but the storage battery voltage is about 12V, when general charge controller is charging, the voltage of the solar battery is about 12V, the maximal power is not fully exerted. MPPT controller can overcome the problem and adjust the input voltage and current of the battery panel from time to time so that the input power can be the maximal value.

Comparing with traditional PWM controller, MPPT controller can exert the maximal power of solar battery. Therefore, bigger charge current can be provided. Generally speaking, compared with PWM controller, MPPT can improve energy utilization ratio by 15%~20%.

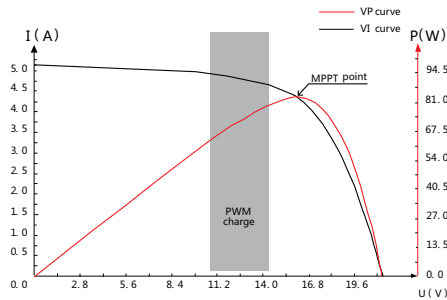

Fig.1-2 Output Characteristic Curve for Solar Battery

Owing to different ambient temperature and illumination conditions, maximal power point can change frequently. Our MPPT controller can adjust parameters according to different conditions so that the system can be close to the maximal operation points at any time. The whole process is completed fully automatically without any adjustment by users.

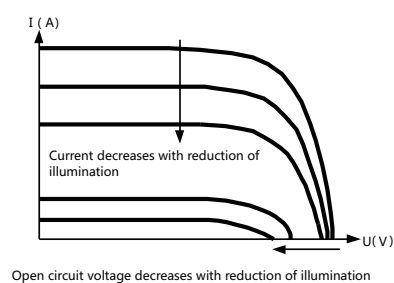

Fig.1-3 Relation Between Solar Battery Output Characteristics and Illumination

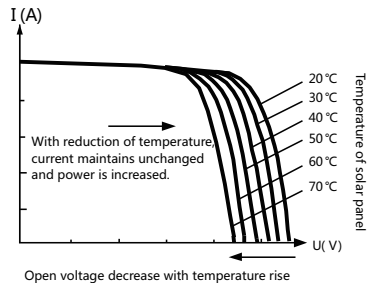
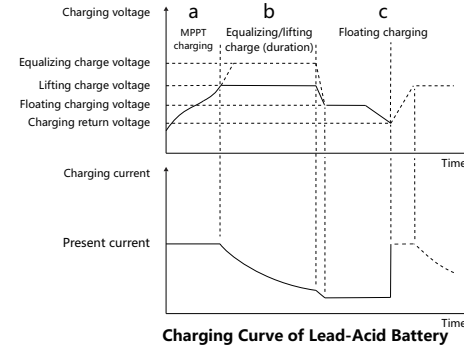

Fig.1-4 Relation Between Solar Battery Output Characteristics and Illumination

1.6 Introduction to Charging Stage (MPPT, Constant Voltage and Current)

1.6.1 Charging process of lead-acid battery

As one of the charging processes of lead-acid batteries, MPPT usually needs to be combined with equalizing charge/lifting charge, floating charging and other charging methods to jointly complete the charging management for storage batteries.



Charging Curve of Lead-Acid Battery

The charging stages of lead-acid batteries include MPPT charging, constant voltage charging (equalizing/lifting/floating charging) and current limiting charging.

a) MPPT charge

In MPPT charging stage, the battery voltage has not reached the target constant voltage value, so the controller will perform MPPT charging to maximize the charge amount from solar energy quantity to the storage battery. After the storage battery voltage reaches the constant voltage value, it shall automatically change to constant voltage charging.

b) Constant voltage charge

When the storage voltage reaches the target constant voltage value, the controller shall exit from MPPT charging and enter into constant voltage charging. With the progress of constant voltage charging, charging current shall drop gradually with time lapse. Constant voltage charging is divided into two stages, namely equalizing charge and lifting charge respectively. These two charging process shall not repeated (the equalizing charge interval is 30 days at a time by default).

c) Equalizing charge

Warning: Explosion Risk!
Equalizing open-head lead-acid batteries can produce explosive gases and battery compartments must be well ventilated.

Note: Device Damage!
Equalizing may increase battery voltage, but damage the level of sensitive DC load. Therefore, it is necessary to validate that the allowable input voltage of all loads is greater than the set equalizing charge value.

Note: Device Damage!
Excessive charging and gas evolution may damage polar board of storage and result in peeling of active substances on the battery plate. Too high equalizing charge voltage or too long charging time may damage batteries. Please set related parameters according to the specification requirements of the batteries used in the system.

Some types of batteries benefit from periodic equalizing charge, which mainly increases the charging voltage of batteries so that it is higher than the standard supply voltage. Equalizing charge can gasify the battery electrolyte, balance the battery voltage and complete the chemical reaction. Equalizing charge and lifting charge are not repeated in a charging process to avoid too much precipitated gas or overheated battery.

➤ Lifting charge

Generally, it is considered that the lifting charge stage lasts for 2h by default. When the duration reaches the set value, the system shall turn to the floating charge (lifting charge duration: only the self-defined battery type can be changed).

➤ Floating charge

Floating charge is the last stage for constant voltage of lead-acid storage. The controller keeps the charging voltage at the floating charge voltage. At this stage, weak current charge is performed for the battery at this stage to guarantee that the battery maintains at the full charging state.

At floating charge stage, when the battery voltage drops to the lifting charge return voltage, after a period of time, the system shall exit from the floating charge stage and then enter into MPPT charge stage again.

1.5.21.5.2 Charging Process of Lithium Battery/Customized Lithium Battery

The charging stages of lithium batteries contain MPPT charging, constant voltage charging, and current-limiting charging

a) MPPT charging

In MPPT charging stage, the battery voltage has not yet reached the target constant voltage. The controller will perform MPPT charging to maximize the charge amount from solar energy quantity to the storage battery. After the storage battery voltage reaches the constant voltage value, it shall automatically change to b) constant voltage charging.

b) Constant Voltage Charging

Lifting charge is the unique constant voltage charge state. Therefore, only when the storage voltage drops to the set value for lifting and recovering charge, the system can exit from the constant voltage charging stage and then enter into MPPT charging stage again.

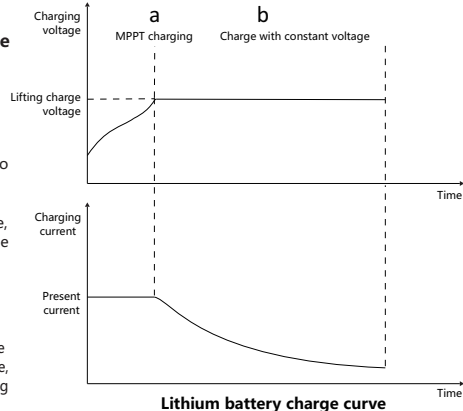

1.5.3 Current-limiting charge over rated current

Current-limiting charge runs through the whole charging cycle. In any charging stage, as long as it is detected that the current is beyond the rated current, it shall enter into the current-limiting charge automatically and the charging current is limited to the rated current.

1.5.4 Overtemperature and Current-Limiting Charge of Device

Overtemperature and current-limiting charge of device runs through the whole charging cycle. In any charging stage, as long as overtemperature of device is detected, it will automatically enter into linear current-limiting charge.

2. Technical Parameter

2.1 Electrical parameter

Name of Parameter	Parameter Value			
	SGC481585A	SGC4815100A	SGC482585A	SGC4825100A
Type	SGC481585A SGC4815100A SGC482585A SGC4825100A			
System Voltage	12V/24V/36V/48V			
No-load loss	0.54W			
Battery voltage	9V~64V			
Maximum PV open-circuit voltage	150V		250V	
Maximum PV input current	70A			
Maximum PV short-circuit current	70A			
Maximum voltage range at power point	Battery voltage +2~120V		Battery voltage +2~180V	
Rated charging current	85A	100A	85A	100A
Settable charging current	0-85A	0-100A	0-85A	0-100A
Maximum output overcurrent protection	85A	100A	85A	100A
Maximum output power	4400W	5280W	4400W	5280W
Power of solar panel (12V)	1100W	1320W	1100W	1320W
Power of solar panel (24V)	2200W	2640W	2200W	2640W
Power of solar panel (36V)	3300W	3960W	3300W	3960W
Power of solar panel (48V)	4400W	5280W	4400W	5280W
Charging conversion efficiency	≤98%			
MPPT tracing efficiency	> 99%			
Temperature compensation coefficient	-3mV/°C/2V (default, settable lead-acid); no temperature compensation for lithium battery.			
Communication way	TTL/Isolated RS485; baud rate 9600, digital bit 3, stop bit 1, no check bit			
Bluetooth	Built-in bluetooth 4.0BLE module, achieving mobilephone APP monitoring			
Internal temperature protection	When interior temperature of controller is higher than the set value, it shall perform linear power reduction operation			
External temperature sampling of battery	The temperature is used for battery temperature compensation and battery temperature protection			
Programmable relay	DPST 10A/250VAC ; 10A/30VDC			
Protection function	Battery overcharging protection, battery over discharge protection, PV anti-reverse protection, reverse charge protection at night, interior overtemperature protection of controller and over-current protection in charge			
Operation temperature	-35°C ~ +65°C(No derating within 40 °C)			
Degraded ambient temperature	40 °C			
Elevation	≤3000m			
Protection grade	IP32			
Weight	5.7kg			
Product size	Conventional : 314*227*121mm MC4 : 314*259*121mm			

2.2 Battery Type Parameter by Default

Parameter Contrast of Different Types of Battery					
Battery type Set Voltage	Sealed lead-acid battery	Colloidal lead-acid battery	Open-head lead-acid battery	Lithium battery	Self-defined User (12V by default)
Overvoltage breaking voltage	16.0V	16.0V	16.0V	16.0V	9 ~ 17V
Equalizing voltage	14.6V	—	14.8V	—	9 ~ 17V
Lifting voltage	14.4V	14.2V	14.6V	14.4V	9 ~ 17V
Floating voltage	13.8V	13.8V	13.8V	—	9 ~ 17V
Lifting recovery voltage	13.2V	13.2V	13.2V	13.2V	9 ~ 17V
Overdischarge recovery voltage	12.6V	12.6V	12.6V	12.6V	9 ~ 17V
Undervoltage alarm	12.0V	12.0V	12.0V	12.0V	9 ~ 17V
Overdischarge voltage	11.1V	11.1V	11.1V	11.1V	9 ~ 17V
Overdischarge cutoff	10.6V	10.6V	10.6V	10.6V	9 ~ 17V
Overdischarge delay	6S	6S	6S	6S	1-30S
Equalizing charge interval	30days	0days	30days	—	0 ~ 250days (0 indicate closing and equalizing charge function)
Equalizing duration	120 minutes	—	120 minutes	—	10 ~ 600 minutes
Lifting duration	120 minutes	120 minutes	120 minutes	—	10 ~ 600 minutes
Temperature compensation mV/°C/2V	-3	-3	-3	—	Automatic removing temperature compensation for lithium

3. State instruction for indicator light

3.1 Charge state indication

No.	State of Indicator Light	Charge State
①	Normal on	MPPT Charge
②	Slow flash (on 1s, off 1s, period 2s)	Lifting charge
③	Single flash (on 0.1s, off 1.9s, period 2s)	Floating charge
④	Quick flash (on 0.1s, off 0.1s, period 0.2s)	Equalizing charge
⑤	Double flash (on 0.1s, off 0.1s, on once again 0.1s, off once again 1.7s, period 2s)	Current limiting charge
⑥	Off	No charge is started

3.2 State Display of Battery

Color of Indicator Light	State of Indicator Light	State of Battery
Green	Normal on	Full battery voltage
Yellow	Normal on	Normal battery voltage
Red	Normal on	Battery voltage is below the undervoltage point
	Quick flash (on 0.1s, off 0.1s, period 0.2s)	Battery overvoltage or overtemperature

3.3 Type Indication of Battery

Color of Indicator Light	Type of Battery
Red	Open-head lead acid battery FLD
Yellow	Colloidal lead acid battery GEL
Green	Sealed lead acid battery SLD
Blue	12V lithium battery LI (lithium iron phosphate by default)
Purple	24V lithium battery LI (lithium iron phosphate by default)
Orange	36V lithium battery LI (lithium iron phosphate by default)
Cyan	48V lithium battery LI (lithium iron phosphate by default)
White	Self-defined USE (12V sealed lead acid by default)

4. Key

4.1 Key function I: set battery type

Press the key for 8s and the battery type indicator light starts flickering (the controller can turn off the charge at this time). At this time, after each press, the battery type indicator light turns to another color and there is a corresponding battery type. After the battery type is selected, press the key for 8s once again or 15s after no operation, the controller shall automatically save the battery type set at present and exit from the setting mode and enter into the normal operation mode; (LCD is the standard configuration. Generally, this method is not used for setting).

Self-defined battery → open-head lead acid battery → colloidal lead acid battery → sealed lead acid battery
 (White) (Red) (Yellow) (Green)
 ↑ ↓
 48V lithium battery ← 36V lithium battery ← 24V lithium battery ← 12V lithium battery
 (Cyan) (Orange) (Purple) (Blue)

4.2 Key function II: recover factory default parameter

Press the key for 20s and the red indicator light of the three ones on the controller flickers and the controller is restored to the factory default parameters.

5. Parameter Setting and Special Function Use

5.1 Monitoring Use of Mobile Phone APP (Standard Configuration)

Blue tooth 4.0BLE module is integrated in the controller and users can use the mobile phone APP developed by our corporation to achieve data monitoring, setting and other operations to the controller.

Please contact business personnel to get related software and operation instruction.

5.2 Application of Lead Acid Battery

1) The LCD screen on the controller (see 6.3 set system parameters via the LCD screen) or mobile phone APP can be used to select the battery type matched with the battery. The changed system voltage can be effective only upon restart.

2) If the preset lead-acid battery parameters are not suitable for the battery used by users and users can use customization. All parameters customized can be set only through communication, such as mobile phone APP, PC client software, or perform communication setting via other user system in accordance with communication protocol and controller.

(At delivery: the self-defined default values are same as the sealed lead acid battery parameters. The system voltage is 12V)

5.3 Application of Lithium Battery

Preset LI for controller containing lithium iron phosphate of specifications 12V/24V/36V/48V. If the preset values for the lithium battery are not suitable for users, you can perform communication setting with the controller via mobile phone APP, LCD screen of the device, external LCD screen and other systems according to the communication protocol through other systems of the user.

Customization may be lead-acid batteries or lithium batteries. To apply lithium batteries in the self-defined battery type, it is required to meet the following conditions:

- 1) Set a fixed voltage for the system voltage, one of 12V/24V/36V/48V.
- 2) Equalizing charging time interval is set as 0;
- 3) Equalizing charging time is set as 0;
- 4) Temperature compensation is set as 0.

Meeting the above four conditions, the system automatically identifies the batteries as lithium batteries. Therefore, the system possesses lithium battery activation, charging and other charge control logic.

5.4 Setting of Charging Current

The rated current of the controller is 100A, which supports the setting of communication instructions, ranging from 0.00 A to 100.00A. Via mobile phone APP or the user system provided by our company, communication setting is performed for specified register E001H with the controller via the mobile phone APP or the user system according to the protocol. Please refer to our Modbus protocol for setting and analysis.

5.5 Definition of RS485 Communication Interface

- 5.5.1 Set as communication mode
Users can utilize Modbus protocol to perform data monitoring, parameter setting and other operations via the port for the controller via the port.
- 5.5.2 Set as parallel operation mode
The parallel operation mode can be used only after the device is set as parallel operation mode,
- 5.5.3 Remote on/off of charger
Two pieces of remote on/off input signal are integrated in 485 communication wire.
The charging can be broken only by short circuit of pins ⑤ and ⑥ in the communication wire.

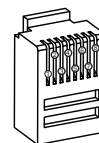

No.	Definition	No.	Definition
①	NC	⑤	Isolate power ground
②	NC	⑥	D-
③	Remote on/off of charger	⑦	D+
④	Remote on/off of charger	⑧	Isolate positive power supply

5.6 TTL Communication

Users can utilize Modbus protocol to perform data monitoring, parameter setting and other operations for the controller via the port.

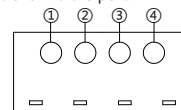

No.	Definition
①	Controller supplies +12.8V outwards.
②	Data receiving terminal RX of controller
③	Data sending terminal TX of controller
④	GND

5.7 Temperature Sampling of Battery

Not connected to temperature sensor, it is 25°C by default; After the temperature sensor is connected, high and low temperature protection is performed or charging temperature compensation is performed for the battery (there is no temperature compensation for lithium battery).

Wiring method: the wiring terminal of the temperature sensor is connected to (9) and the temperature sensor is fixed thereon.

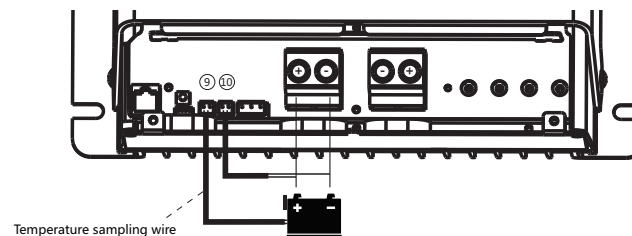

5.8 Voltage Compensation Wire of Battery

Owing to the configuration, the charging power is great and the diameter of wire from battery to the controller is small. Therefore, the voltage collected by the controller terminal is greater than the practical voltage of the battery terminal and the battery cannot be fully charged. In certain degree, the voltage of the battery terminal can be more accurately collected via the voltage sampling wire of the battery and the voltage difference can be output in a compensated way, so that the battery terminal can get more reasonable charging voltage.

The positive and negative poles of the battery are respectively connected to the positive and negative poles of the battery voltage sampling terminal (10) via the voltage compensation wire. Please note that the left is the positive terminal and the right is the negative terminal.

The wiring way is shown in the figure below:

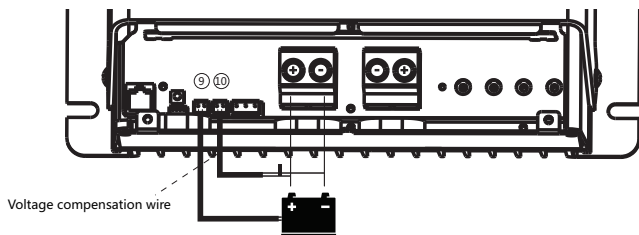

5.9 Programmable Relay Output

- Single-pole double-throw (DPST) relay
- Relay contact specification 250VAC/10A, 30VDC/10A
- From left to right, there are NC contacts, common points and NO contacts.

Relay triggering condition:

- 1) When battery voltage is normal, the relay coil doesn't operate in NC state (C and NC are conducted)
- 2) In case of overvoltage or over discharge of the battery, relay coil operates in NO state (C and NO are conducted)

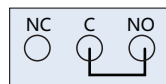
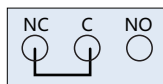

5.10 Use of Parallel Operation Function

5.10.1 Parallel operation function:

Parallel operation function means that several controllers charge one battery pack one to one uniformly. Each controller has one independent solar panel; these controllers are connected via RS485 communication wires and the host system uniformly synchronizes the charge state stage, constant voltage value and other parameters to the slave. In this way, the device can break through the power limit of single device. In addition, parallel operation of several devices can meet greater charging power demands.

5.10.2 Parallel operation step:

- 1) RS485 communication ports of each controller are set as parallel operation function

The device is only designed with a 485 communication. Therefore, parallel operation function is required and it is necessary to set RS485 communication function as the parallel operation function (for related protocol data, please refer to our Modbus protocol)

PDU Operation Address	Data	Function
E327H	0000H	RS485 communication interface is taken as communication function (default)
E327H	0001H	RS485 communication interface is used as parallel operation function

- 2) The device addresses of each controller are set as 1, 2, 3, 4..... according to the sequence.
- 3) D+ of different RS485 communication wires are connected together and D- are connected together in parallel.
- 4) Afterwards, power is supplied to these controllers.

Note:

- 1) Host and slave are decided and changed by software algorithm, namely host and slave identifications are not determined.
- 2) As long as it is not the time when the host sends the synchronizing information, operation to E327H is effective.
- 3) The parallel operation function can also send and receive data within certain time of period. However, if data receiving and sending is at the time when the host sends synchronizing data to 485 bus, there maybe communication data conflict error!!!
- 4) The controller unit can automatically identify the host and the host shall regularly send the synchronizing information to RS485 bus. The slave receives the information for implementation.
- 5) During parallel operation process, once the host fails to perform charging or doesn't perform charging, the slave meets the charge. After a period of time, the slave shall generate new host to further manage the charge. At this time, previous host becomes a slave.

6. Liquid Crystal Display

LCD module as the standard configuration of the controller can be installed on the controller surface or in other places via DB9 extension wire in accordance with practical conditions.

6.1 Menu Schematic Diagram

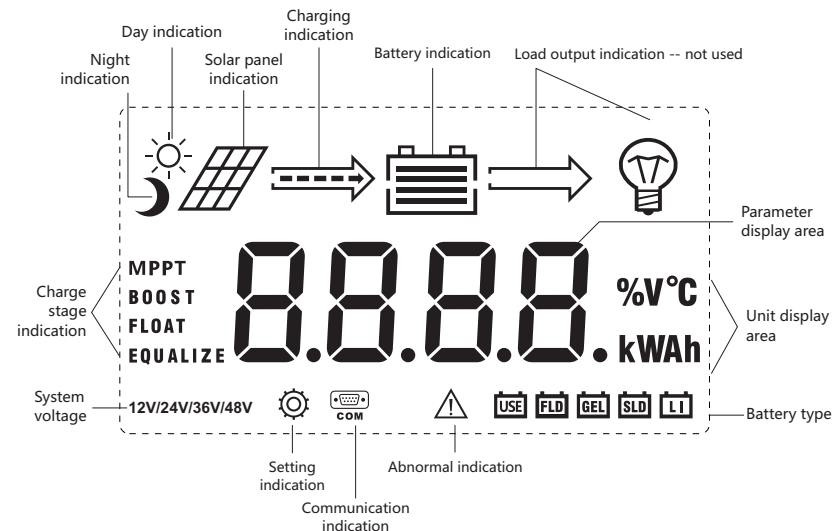

6.2 Menu Browse

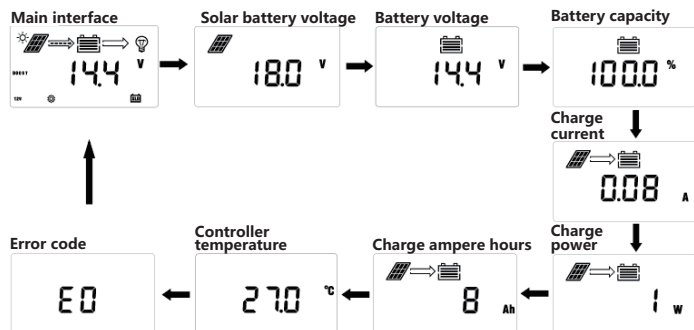

6.3 Set System Parameter via LCD

Setting method:

1). Under any menu, press key "ENTER" for long time to enter into "Parameter Setting" menu:

- (1) Press key "ENTER" for short time and adjust the parameter value;
- (2) Press key "SELECT" for short time and select setting item;
- (3) Press key "ENTER" for 2 seconds, save and exit from setting mode;
- (4) Select "FLD/GEL/SLD/LI" battery type and press key "SELECT" to only perform switching between "system voltage" and "battery type".
- (5) After selecting "USE" for customizing battery type, press key "SELECT" for switchover among "system voltage /equalizing charging voltage/lifting charging voltage/floating voltage/over discharge return voltage/over discharge voltage".

Note:

- (1) The changed "system voltage" can be effective only after poweron again.
 - (2) Users must be careful while customizing parameters. The system may not operate normally owing to inaccurate parameter!
- 2) Customized USE menu

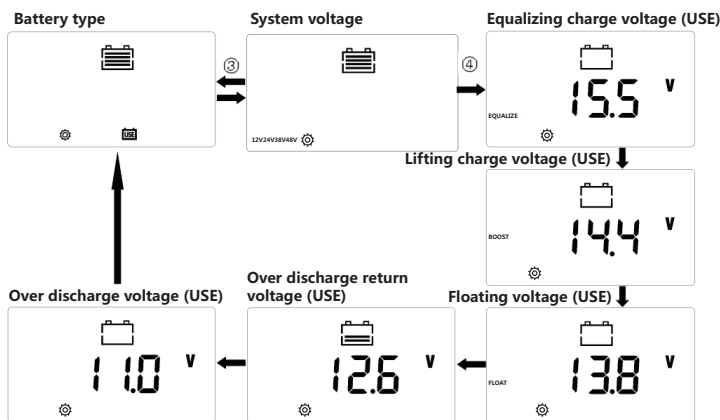

No.	Liquid Crystal Display	Set Item	Parameter Range	Remark
1	USE	Battery type	--	Customizing battery type
2	12V/24/36V/48V	System voltage	12V/24/36V/48V	"12V/24/36V/48V" simultaneous on indicates automatic identification
3	EQUALIZE	Equalizing charging voltage (USE)	9.0 ~ 17.0V	--
4	BOOST	Lifting charging voltage (USE)	9.0 ~ 17.0V	--
5	FLOAT	Floating charging voltage (USE)	9.0 ~ 17.0V	--
6		Over discharge recovery voltage (USE)	9.0 ~ 17.0V	--
7		Over discharge voltage (USE)	9.0 ~ 17.0V	--

6.4 Abnormal Code Display

No.	Error Code Displayed by LCD	Note	Implementation Result
1	E0	No abnormality	Normal system
2	E1	Battery over discharge	Battery voltage rises to over discharge return voltage and over discharge prompt is released.
3	E2	Battery over voltage	No charging
4	E3	Under voltage alarm of battery	Battery voltage is lower than undervoltage alarm threshold value, it is only prompted that the system is normal.
7	E6	Interior over temperature of controller	Excessive internal temperature of controller, MPPT controller starts linear power charge; it shall recover automatically after reducing to certain value.
8	E7	Battery over temperature	Turn off the charging and then recover the charging automatically after the voltage is lower than certain value.
9	E8	Excessive charge current of input power of solar panel	MPPT controller is limited within rated current range
10	E10	Over voltage of solar panel	Over voltage of solar panel, turn off the charging and recover the charging when the voltage is lower than the set value.
12	E15	Battery not connected or feedback electricity of lithium battery	As long as the solar panel voltage meets the charging condition, lithium battery has constant voltage output, lead-acid battery has no voltage output, and it shall recover to normal after the battery is connected.
13	E16	Over temperature of battery	No charging
15	E18	BMS over charge protection	No charging
16	E19	Low temperature of battery	No charging

6.5 Common Problem and Treatment Method

Phenomenon	Treatment Method
Indicator light or LCD is not on	Please check whether battery and solar panel are correctly connected.
No datum on LCD	Poor communication; check the communication wire.
There is voltage on the solar panel, no voltage output at battery end, display code E1	No battery can be detected at the lead-acid battery terminal. There is no voltage output from both ends of the battery. It shall return to normal state after battery is connected.
Connected with 12V/24V/36V/48V normal voltage battery and the battery icon on the LCD flashes slowly, display error E1	Check whether it is set as corresponding system voltage or automatic identification, restart the controller; After setting the system voltage, it is designed for safety and can be effective only after restart.
Battery icon indicator light flashes quickly without charging. Display code E1	Overvoltage of system; inspect the overvoltage reason of the battery. It shall restore after reduction of voltage.
The device cannot be searched by mobile phone Bluetooth.	Inspect whether other mobile phones are connected with the Bluetooth setting.
No charging by controller.	Inspect whether wires are correctly connected, whether solar panel voltage exceeds the rated value, whether battery exceeds the voltage, check LCD error code. Inspect whether there is interior overtemperature, exterior overtemperature, low temperature of exterior lithium, or whether the lead-acid battery is open, etc.
Other problem or insoluble abnormality	Try to restore the factory setting and then set related parameters in accordance with system configuration. Take care in the operation!

6.6 Installation Size of LCD

Product size:104.5*55.5*11.8mm

Installation size: 96*φ3.5mm

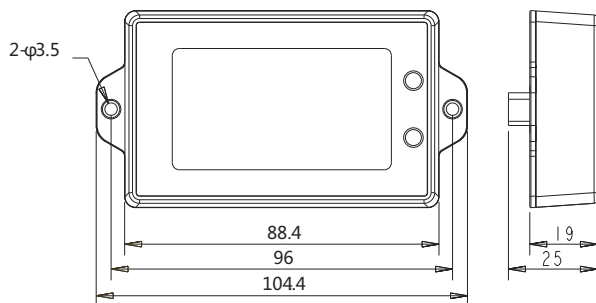

7. Product Installation

7.1 Installation Notice

- ◆ Please be careful in battery installation. To open the open-head lead-acid battery, it is required to wear a pair of goggles. Once contacting the acid liquid of the battery, please flush with clear water immediately.
- ◆ Avoid placing metal articles close to the battery to prevent short circuit of battery.
- ◆ The battery in charging may generate acid gas, so please guarantee well-ventilated ambient.
- ◆ The battery may generate flammable gas, please keep away from spark.
- ◆ Please avoid direct sunlight and rain water in outdoor installation.
- ◆ The virtually connected points and corrosive wires may generate heat and melt the insulation layer of the electric wire, burn surrounding materials and even cause fire. Therefore, it is required to guarantee that all connectors are tightened. The electric wires shall be fixed with wire ties to avoid connector looseness in mobile application.
- ◆ To connect the system, the voltage at the output terminal of the component may exceed safe body voltage. Therefore, it is required to use insulation tools in operation and guarantee dry hands.
- ◆ The wiring terminal of the battery on the controller can be connected with only one battery, or with a set of battery. In the manual, the instructions are only for one battery. However, they are applicable to a set of batteries.
- ◆ Please observe the safe suggestion of the battery manufacturer.
- ◆ The system connecting wire is selected based on the current density no less than 4A/mm².
- ◆ The ground terminal of the controller shall be grounded.
- ◆ In installation, the battery shall not be reversely connected, which may cause irreversible damage!

7.2 Wiring Specification

It is required to observe national and local electrical specification requirements for wiring and installation ways. PV and battery wiring specification must be selected based on rated current. Please refer to the table below for the wire specification.

Type	Maximal input current of PV	Maximal wire size at PV terminal (mm ² /AWG)	Rated charge current	Wire size of battery (mm ² /AWG)
SGC481585A	60A	15/5	85A	21/4
SGC4815100A	70A	18/4	100A	25/2
SGC482585A	60A	15/5	85A	21/4
SGC4825100A	70A	18/4	100A	25/2

Earthing instructions: The screw hole at the side earthing mark of the radiator is earthing. If earthing is needed, the diameter of earthing wire shall not be less than 15/5(mm² /AWG)

7.3 Installation and Wiring

⚠ Warning : Explosion hazard! Never install the controller and open-head battery into an enclosed space or in an enclosed room with possible gathering of battery gas.

⚠ Warning : High voltage is hazardous! Photovoltaic array may generate high open voltage. Before wiring, please break the breaker or fuse. Please be careful during the connection process.

⚠ Note : To install the controller, please guarantee that there is enough air flowing through the cooling fin of the controller. At least leave 150mm space above or below the controller so as to guarantee natural and convective heat dissipation. If installed in an enclosed box, please guarantee reliable heat dissipation via the box.

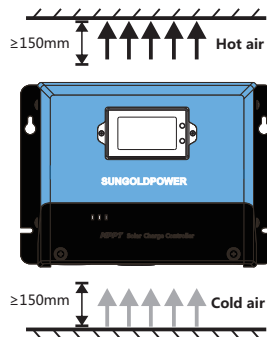

Fig. 2.1 Installation and Heat Dissipation

Step 1: select an installation place

It is prevented to install the controller to a place with direct sunlight, high temperature and possible water inlet. In addition, it is required to guarantee well ventilation around the controller.

Step 2: fix screw

Mark a sign at the installation position in accordance with the installation size of the controller. Drill four installation holes with proper size at 4 marking positions. Afterwards, fix the screws to the upper two installation holes.

Step 3: fix controller

Align the fixing hole of the controller with two screws fixed in advance, then hang the controller and fix the lower two screws.

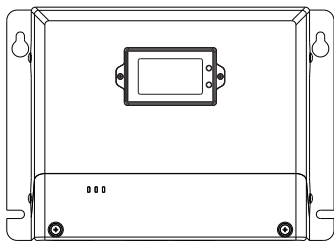
**Step 4: Wiring**

In order to guarantee safety in installation, we recommend a wiring sequence for the main circuit; it is prohibited to connect the positive and negative poles of the battery reversely!!!!

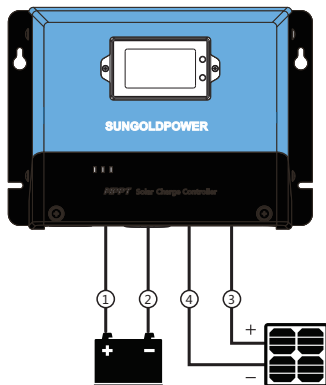

Warning: : Danger of electric shock! We strongly recommend to connect the fuse or breaker at the photovoltaic array and the battery terminals to prevent electric shock hazard in wiring or inaccurate operation. Furthermore, before wiring, it is required to guarantee that the fuse or breaker is in open state.

Warning: : Danger of high voltage! Photovoltaic array may generate high open voltage. Before wiring, please open the breaker or fuse,

Warning: : Danger of explosion! Short circuit of positive and negative terminals of battery and wires connected to the positive and negative poles may cause fire or explosion. Please take care in operation. Please connect the battery at first and then the battery panel. Please observe the connecting way of pole "+" before pole "-".

When all power lines are connected firmly and reliably, inspect whether the wires are correct once again and whether the positive and negative poles are connected reversely. After it is confirmed that all are correct, connect the battery fuse or breaker at first and then observe whether LED indicator light is on. If the light is not on, please immediately cut the fuse or breaker, and then inspect whether the wires are correctly connected.

If the battery is connected normally, connect the battery panel. If the sunlight is sufficient, charging indicator light of the controller shall be normally on or flickers, start charging the battery.

Warning: install the battery fuse close to the battery terminal as far as possible. It is suggested that the installation distance shall not exceed 150mm.

8. Protection Function

8.1 Introduction to Protection Function

- **Waterproof**

Waterproof grade: IP32

- **Overtemperature protection inside device**

When interior temperature of the controller is beyond the set value, the controller shall reduce the charging power or even break automatically in charging to further slow down temperature rise in the controller.

- **Overtemperature protection of battery**

To achieve overtemperature protection of battery, it is required to connect the temperature sampling sensor of battery externally. When it is detected that the battery temperature is high, stop charging. When the battery temperature is reduced to be lower than the set value by 5°C, charge shall be restored automatically after two seconds.

- **Overpower protection for input**

When the battery panel power is greater than the rated power, the controller shall limit the charge power within the rated power range to prevent controller damage caused by excessive current. At this time, the controller shall enter into the current limiting charge.

- **Overvoltage of photovoltaic input terminal**

In case of excessive voltage at photovoltaic array input terminal, the controller shall automatically cut the photovoltaic input.

- **Reverse protection for photovoltaic input**

When the photovoltaic array polarity is connected reversely, the controller shall not damage and shall further operate after wiring error is corrected.

- **Anti-reverse charge protection at night**

It is required to prevent the accumulator against discharge via solar battery.

Special notice: there is no reverse wiring protection function for battery.

9. System Maintenance

In order to guarantee that the controller can maintain the optimum operation performance for long time, it is suggested to inspect following items regularly.

- Confirm that air flow around the controller cannot be blocked and clear away the dirt or sundries on the radiator.
- In case of abnormal failure or error prompt, adopt corrective measures in time.
- Inspect whether there is corrosion, insulation damage, high temperature, burning/dicolor sign on the wiring terminal, whether the shell is deformed. If any, perform repair or replacement in time.
- Any wire with exposure, damage, poor insulation performance shall be repaired or replaced in time.
- Any dirt, nesting, insect or corrosive phenomenon shall be cleared in time.

Warning : Danger of electric shock! To carry out above operation, please ensure that all power of the controller has been broken. Afterwards, perform corresponding inspection and operation! Any non-professional shall not operate without authorization.

10. Product Dimension

① Common size :

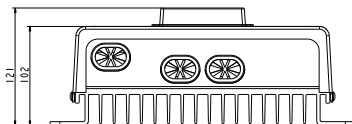
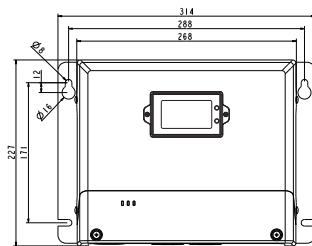
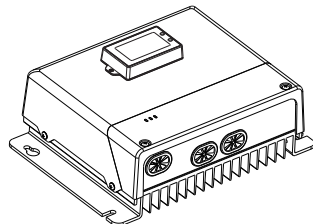

Product size:314*227*121mm
 Installation size:228*171mm
 Fixing hole position: Φ8mm
 Wire specification:20-2AWG

②-MC4 size :

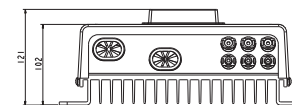
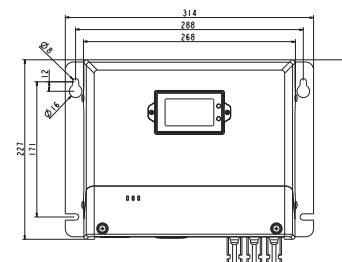
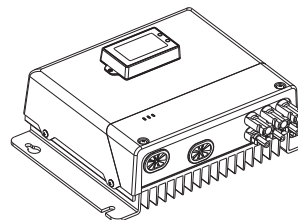

Product size : 314*259*121mm
 Installation size : 228*171mm
 Fixing hole position : Φ8mm
 Wire specification : 20-2AWG

11、 Solar Controller : Solar APP

Download	Google Play (Android)	APP Store (iOS)	Android
Keyword download	Keywords: Solar APP	Keywords: Solar APP	N/A
Download Link	https://play.google.com/store/apps/details?id=com.srne.commonapp	https://apps.apple.com/us/app/solars-app/id6444056453	http://srneobg.haizeihua.cn/1688001411800sol-arapp_20230422092155.apk
Scan			

12、 Controller Input Voltage Specifications

Model	MC4860N15	SGC482560A	SGC4825100A
Maximum PV open-circuit voltage	150VDC	250VDC	250VDC
Minimum PV input voltage(12V system)	18VDC	18VDC	18VDC
Minimum PV input voltage(24V system)	36VDC	36VDC	36VDC
Minimum PV input voltage(48V system)	72VDC	72VDC	72VDC
Minimum battery input voltage(12V system)	9VDC	9VDC	9VDC
Minimum battery input voltage(24V system)	9VDC	9VDC	9VDC
Minimum battery input voltage(48V system)	9VDC	9VDC	9VDC

Mono Power: 415W
Dimensions: 1722*1134*35mm



Characteristics

- High efficiency solar cell to keep the modules efficiency reach to 21.25%.
- Positive tolerance to ensure higher output.
- Excellent performance under weak light conditions.
- Modules withstand extremely (temperature, load and impact) TUV certification.
- All modules combination and packing through stepping current to keep effectively reduce mismatch loss.
- 100% EL test to keep higher quality.

Warranty

- 5 year 95% output warranty, 10 year 90% output warranty, 25 year 80% output warranty.
- 12 years material and workmanship warranty.



Anodized aluminum frame withstand corrosion and damage, Special osculum can reduce destruction by water freeze.

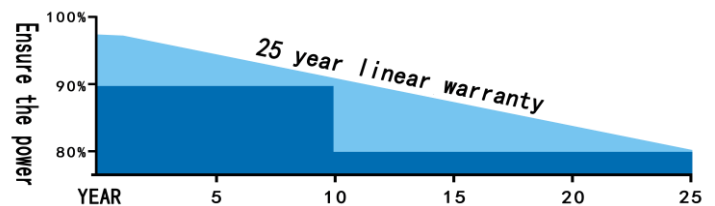

IP68 junction box long-term weather endurance.

Quality and safety

- ISO9001:2015、ISO14001:2015、ISO45001:2018 certified supplier, we provide world first class solar products for clients.
- TUV,IEC,CEC,CE,CB CA 92618 approved.
- UL61730, CEC Listed.



Electrical Characteristics

Model No.	SG415WM
Maximum Power (Pmax)	415W
Max-power Voltage (Vmp)	31.11V
Max-power Current (Imp)	13.34A
Open-circuit Voltage (Voc)	38.32V
Short-circuit Current (Isc)	14.09A
Module Efficiency	21.3%
Operating Temperature	-40 ℉ to 185 ℉ -40℃ ~+85℃
Maximum System Voltage	1500Vdc
Maximum Series Fuse Rating	20A
Power Tolerance	±3%

*STC condition: 1000 W/m²,1.5AM and 25℃ cell temperature.

I-V Curve

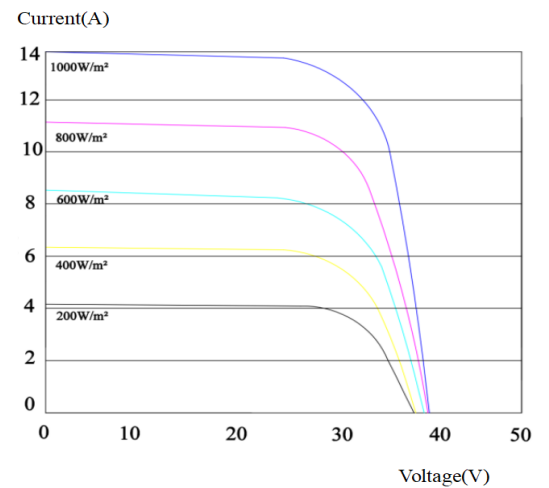

Temperature Characteristics

NMOT	45℃±2℃
Temperature Co-efficient of Pmax	-0.35%/℃
Temperature Co-efficient of Voc	-0.27%/℃
Temperature Co-efficient of Isc	0.048%/℃

Mechanical Characteristics

Mono Power	415W
Cell Type	Mono 182*91mm
Cell Arrangement	108(6*18)
Dimensions	67.80*44.65*1.38inch(1722*1134*35mm)
Weight	48.06lb
Front Cover	3.2mm tempered glass
Frame Material	Anodized aluminium alloy
Junction Box	IP68 rated
Output Cables	4mm ² ,Length: (+) 300mm/ (-) 300mm

Packing

Packing	40HC
Pieces/Pallet	32
Pieces/container	780

Dimensions

