

USER MANUAL

Energy Storage System

Preface

About This Manual





This manual describes the installation, connection, APP setting, commissioning and maintenance etc. of Energy Storage System(ESS). Please first read the manual and related documents carefully before using the product and store it in a place where installation, operation and maintenance personnel can reach it at any time. The illustrations in this user manual are for reference only. This user manual is subject to change without prior notice. (Specific please in kind prevail.)

Target Group

Inverters must be installed by professional electrical engineers who have obtained relevant qualifications.

Conventions

The following safety instructions and general information are used within this user manual.

 DANGER	Indicates an imminently hazardous situation which, if not correctly followed, will result in serious injury or death.
 WARNING	Indicates a potentially hazardous situation which, if not correctly followed, will result in serious injury or death.
 CAUTION	Indicates a potentially hazardous situation which, if not correctly followed, could result in moderate or minor injury.
 NOTICE	Indicates a potentially hazardous situation which, if not correctly followed, could result in equipment failure to run, or property damage.
 NOTE	Call attention to important information, best practices and tips: supplement additional safety instructions for your better use of the Three phase hybrid inverter to reduce the waste of you resource.

CONTENTS

Preface.....	1
About This Manual	1
Target Group	1
Conventions	1
1 Safety.....	4
1.1 Symbols Used	4
1.2 Safety Precaution	5
2 Product Introduction	6
2.1 Overview.....	6
2.2 Product Appearance	7
3 Installation	9
3.1 Packing List	9
3.2 Selecting the Mounting Location.....	10
3.3 Mounting.....	12
4 Electrical Connection.....	13
4.1 Wiring Diagram	13
4.2 Removing Insulation Cover and Grounding Cable.....	22
4.3 Internal Grounding.....	23
4.4 GRID/BACKUP/GEN Connection.....	24
4.5 PV Connection.....	25
4.6 Battery Connection	26
4.7 Communication Connection	27
5 System Operation.....	38
5.1 Inverter Working Mode.....	38
5.2 Startup/Shutdown Procedure	46







6 Commissioning 47
6.1 Inspection 47
6.2 Commissioning Procedure 47
7 User Interface 48
7.1 LED Introduction 48
7.2 LCD Introduction 48
8 Maintenance 81
8.1 Routine Maintenance 81
8.2 Inverter Troubleshooting 82
9 Technical Specifications 87

1 Safety

Before using the inverter, please read all instructions and cautionary markings on the unit and in this manual. Put this manual to a place where you can take it easily.

Our inverter strictly conforms to related safety rules in design and test. Please follow the local laws and regulations during installation, operation and maintenance. Incorrect operation may cause injury or death to the operator or a third party, and damage to the inverter and other properties belonging to the operator or a third party.

1.1 Symbols Used

Safety Symbol	Description
	Danger of high voltage and electric shock! Only qualified personnel may perform work on the inverter.
	Residual voltage exists after the inverter is powered off. It takes 5 minutes for system to discharge to a safe voltage.
	Danger of hot surface
	Environmental Protection Use Period
	Refer to the operating instructions
	Product should not be disposed as household waste.
	Grounding terminal

1.2 Safety Precaution

- Installation, maintenance and connection of inverters must be performed by qualified personnel, in compliance with local electrical standards, wiring rules and requirements of local power authorities and/or companies.
- The temperature of some parts of the inverter may exceed 60 °C during operation. Do not touch the inverter during operation to avoid being burnt.
- Ensure children are kept away from inverters.
- Don't open the front cover of the inverter. Apart from performing work at the wiring terminal (as instructed in this manual), touching or changing components without authorization may cause injury to people, damage to inverters and annulment of the warranty.
- Static electricity may damage electronic components. Appropriate methods must be adopted to prevent such damage to the inverter; otherwise the inverter may be damaged and the warranty annulled.
- Ensure the output voltage of the proposed PV array is lower than the maximum rated input voltage of the inverter; otherwise the inverter may be damaged and the warranty annulled.
- When exposed to sunlight, the PV array generates dangerous high DC voltage. Please operate according to our instructions, or it will result in danger to life.
- PV modules should have an IEC61730 class A rating.
- If the equipment is used in a manner not specified by the manufacturer, the protection provided by the equipment may be impaired.
- Completely isolate the inverter before maintaining. Completely isolate the inverter should: turn off the PV switch and disconnect the PV terminal, battery terminal, and AC terminal.
- After the inverter is powered off, the remaining electricity and heat may still cause electric shock and body burns. Do not touch parts of inverter for 10 minutes after disconnection from the power sources.
- Prohibit inserting or pulling the AC and DC terminals when the inverter is running.
- The BACKUP Port should not be connected to the grid.
- The BAT Port should not be connected to PV and AC voltage. The voltage connected to this port can not exceed 64 V DC.
- The GRID Port should not be connected to PV voltage.
- A single PV panel string should not be connected to two or more inverters.

2 Product Introduction

2.1 Overview

Energy Storage System(ESS)

Typically, an ESS consists of PV array, inverter, battery, loads and electricity sensor.

The inverter is a high-quality machine which can convert solar energy to AC energy and store energy into battery. The energy generated by inverter can be preferentially supplied to its self consumption, stored in the battery for future use or fed into public grid.

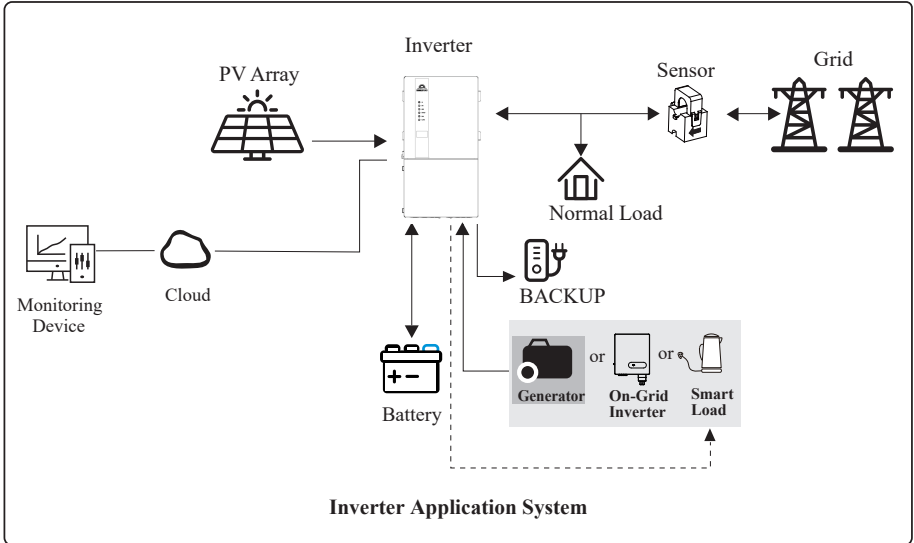

2.2 Product Appearance

• The External View of Inverter

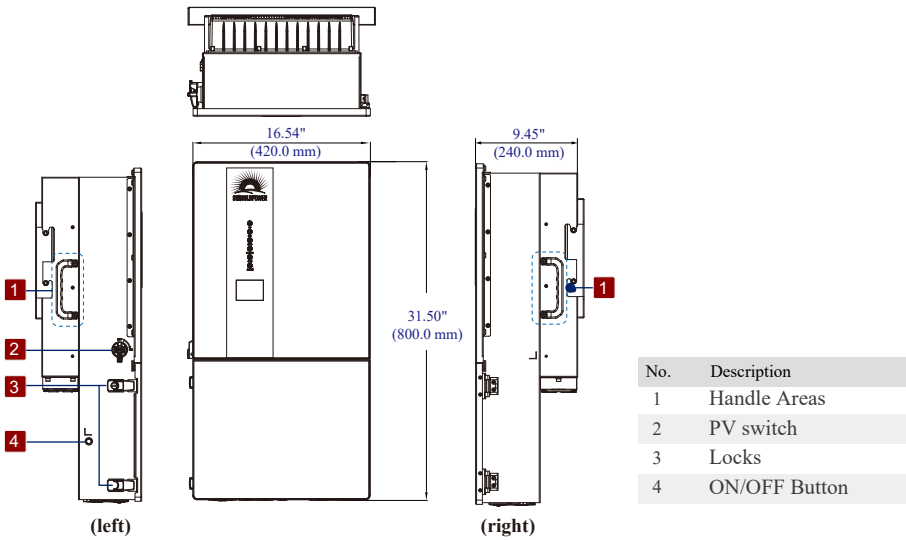

Inverter dimensions:

Width	Height	Depth
16.54" (420.0 mm)	31.50" (800.0 mm)	9.45" (240.0 mm)

LED Details:

Indicator	Description
	PV
	Battery
	Grid
	Backup
	Communication
	Alarm

• The Bottom View of inverter

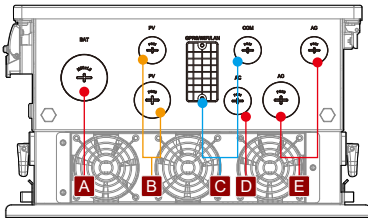

No.	Description
A	Battery connection port
B	PV connection ports
C	Communication connection ports
D	Reserved AC connection port
E	Grounding/GRID/BACKUP/GEN connection ports

• The Dimensions of Waterproof Holes

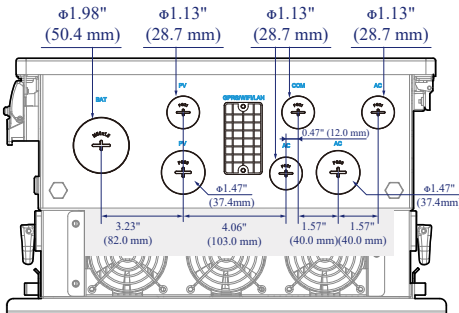

• The Internal Structure of Wiring Box

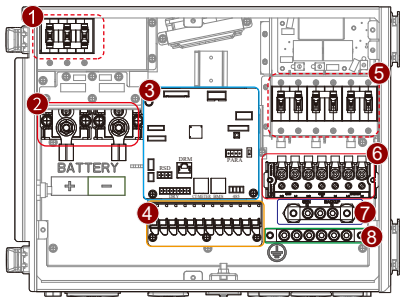

No.	Description
1	Battery breakers (Optional)*
2	Battery terminals
3	Communication connection ports
4	PV input connector
5	AC breakers (Optional)*
6	GEN/GRID/BACKUP terminals
7	Neutral terminals
8	Ground bus bar

* This series of inverters will be equipped with the internal DC (Battery) breakers and AC (Gen, Grid, Backup) breakers, components in No. 1 and No. 5 in the above illustration, by default. However, these breakers can be removed depending on the customer’s needs. This user manual illustrates the default option for reference.

3 Installation

3.1 Packing List

After unpacking, please check the following packing list carefully for any damages or missing parts. If any damages or missing parts occurs, contact the supplier for help.

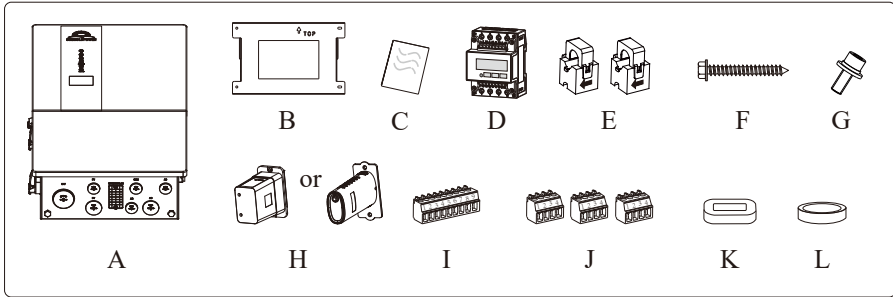

Position	Quantity	Description
A	1	Inverter
B	1	Mounting bracket
C	1	File package
D	1	Meter (Optional)
E	2	Current Transformer (CT) clamp
F	4	M6 Self tapping screws
G	1	M6 Security screw
H	1	WiFi module
I	1	9-Pin terminal
J	3	4-Pin terminal
K	1	AC Toroid, for grid L1/L2/N cables
L	1	DC Toroid, for battery cables

3.2 Selecting the Mounting Location

3.2.1 Installation Environment Requirements

- a. With a NEMA 3R protection rating, the inverter can be mounted indoors or outdoors.
- b. The inverter is suitable for use in residential non-habitable spaces.
- c. The mounting location must be inaccessible to unrelated personnel since the enclosure and heat sinks are extremely hot during operation.
- d. Do not install the inverter in areas containing highly flammable materials or gases.
- e. To ensure optimum operation and long service life, the ambient temperature must be below 50°C.
- f. The inverter must be mounted in a well-ventilated environment to ensure good heat dissipation.
- g. Identify the inverter location on a stub frame, a brick wall or a concrete wall. Ensure the carrier, where the inverter is mounted, can support the weight of the inverter.
- h. Do not install the inverter in a rest area since it will cause noise during operation.
- i. The installation height should be reasonable, and please make sure it is easy to operate and view the display.
- j. Product label and warning symbols shall be clear to read after installation.
- k. To ensure long service life, the inverter must not be exposed to direct solar irradiation, rain, or snow. It is recommended that the inverter be mounted in a sheltered place.

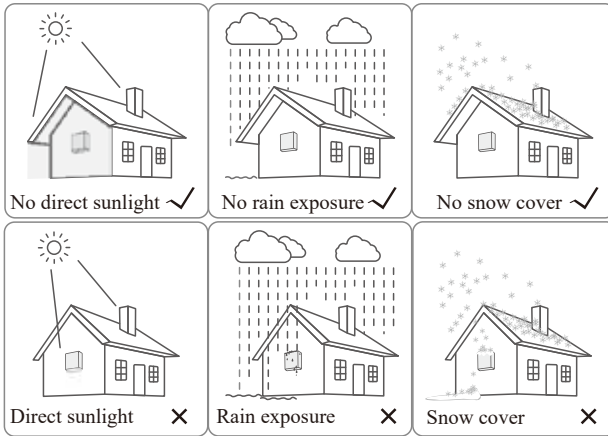

3.2.2 Mounting Requirements

Mount the inverter vertically or at a maximum back tilt of 15°. Do not install the inverter in a wrong direction. Always keep the connection area downward.

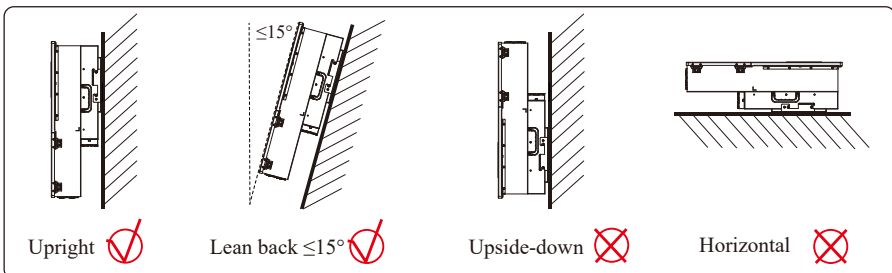

3.2.3 Installation Space Requirements

To guarantee optimal operation and adequate heat dissipation for the machine, the following requirements for clearances should be observed.

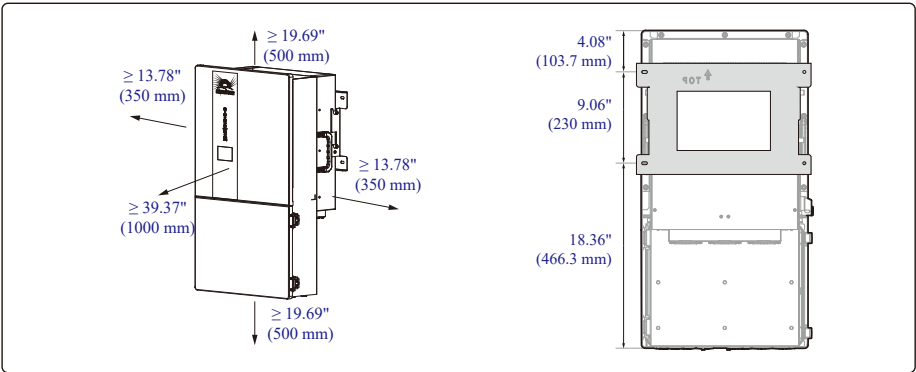



Note:

Ensure all related local laws and regulations have been complied.

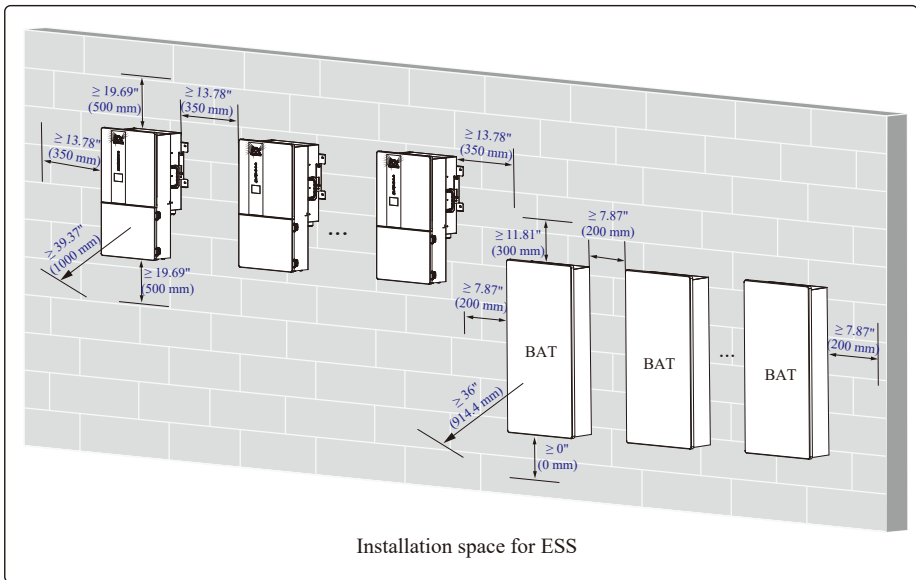
The detailed clearance information below are general guidelines. There should be at least 36 in (1000 mm) of clearance from inverters or batteries to doors or windows.



3.3 Mounting

 <p>DANGER</p>	<p>Before drilling the hole on the wall, ensure no damage on the electric wire and/or water pipe inside the wall.</p>
 <p>CAUTION</p>	<p>The inverter is heavy! Two or three persons are recommended to install the inverter. To prevent potential damages and injuries from inverter falling down, please ensure that the inverter is well-mounted.</p>

Before mounting the inverter, you have to prepare an electric screwdriver and a marker. You may need expansion plugs or anchors for concrete. The dimension of mounting bracket is shown as figure below.

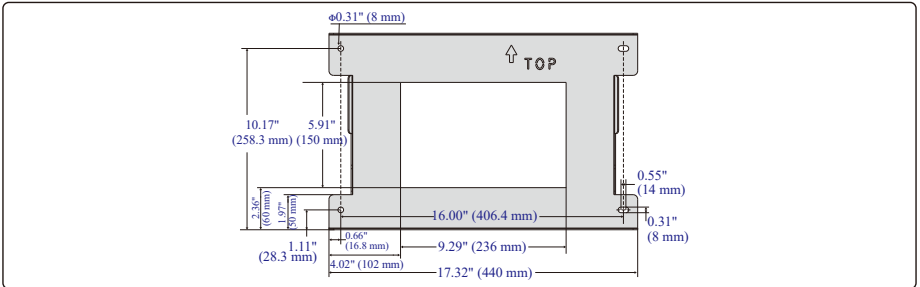

- Step 1.** Position the mounting bracket against the mounting surface, level it, and mark the mounting hole locations.
- Step 2.** Drive the screws through the mounting bracket into the mounting surface. Ensure the bracket is firmly attached.
- Step 3.** Hang the inverter onto the mounting bracket.
- Step 4.** Lock the inverter using the security screw.

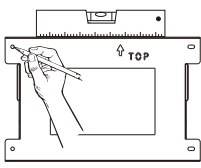
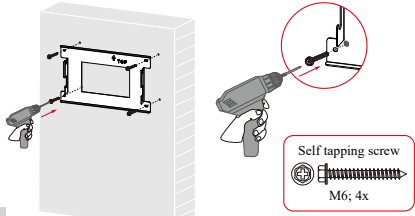
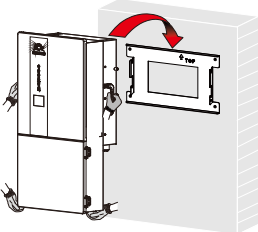
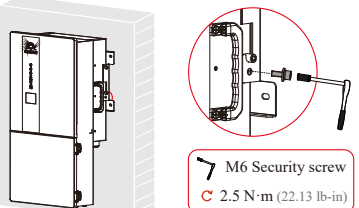
 <p>Set bracket horizontally.</p> <p>1</p>	 <p>2</p>
 <p>3</p>	 <p>4</p>

4 Electrical Connection

This chapter shows the detailed electrical connections of ESS inverter.

 DANGER	<p>Ensure that the inverter and all cables to be installed have been completely powered off during the whole process of installation and connection. Otherwise, high voltage may result in fatal injury.</p>
---	--

4.1 Wiring Diagram

Standard Non-parallel Wiring Diagram

Diagram 01

120/240Vac Split Phase

120/208Vac 2/3 Phase

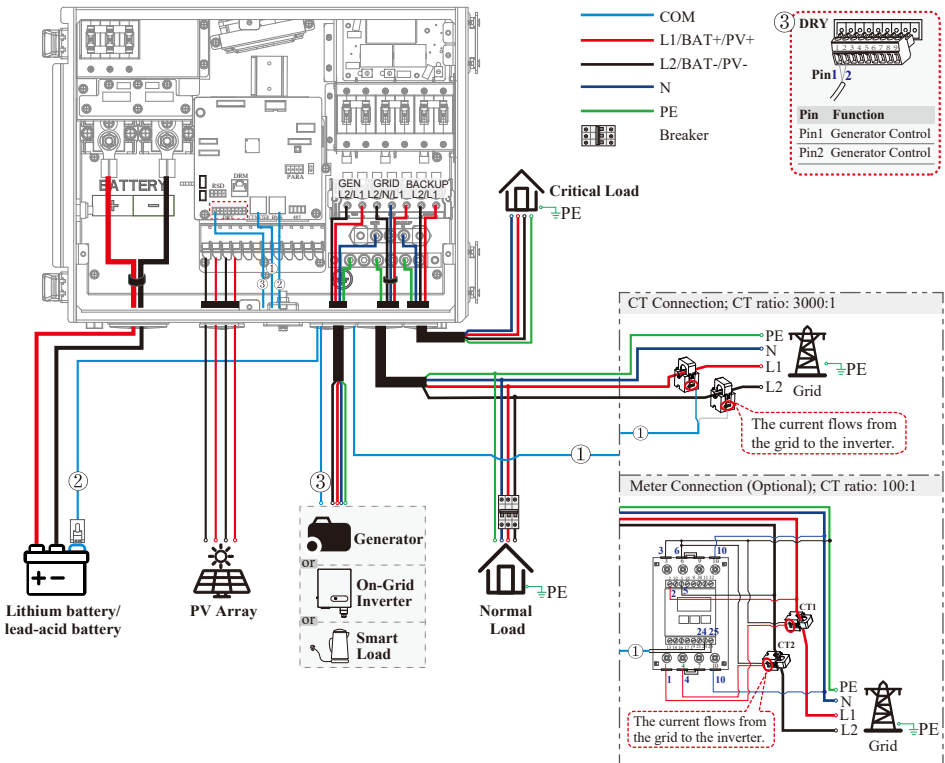

- ① CT/Meter communication connection (meter is optional)
- ② BMS communication connection (only for lithium battery)
- ③ DRY communication connection

* Please refer to the relevant sections of the manual for detailed wiring instructions.

Split Phase Parallel Connection Mode-Scheme A (N=2)

Diagram 02

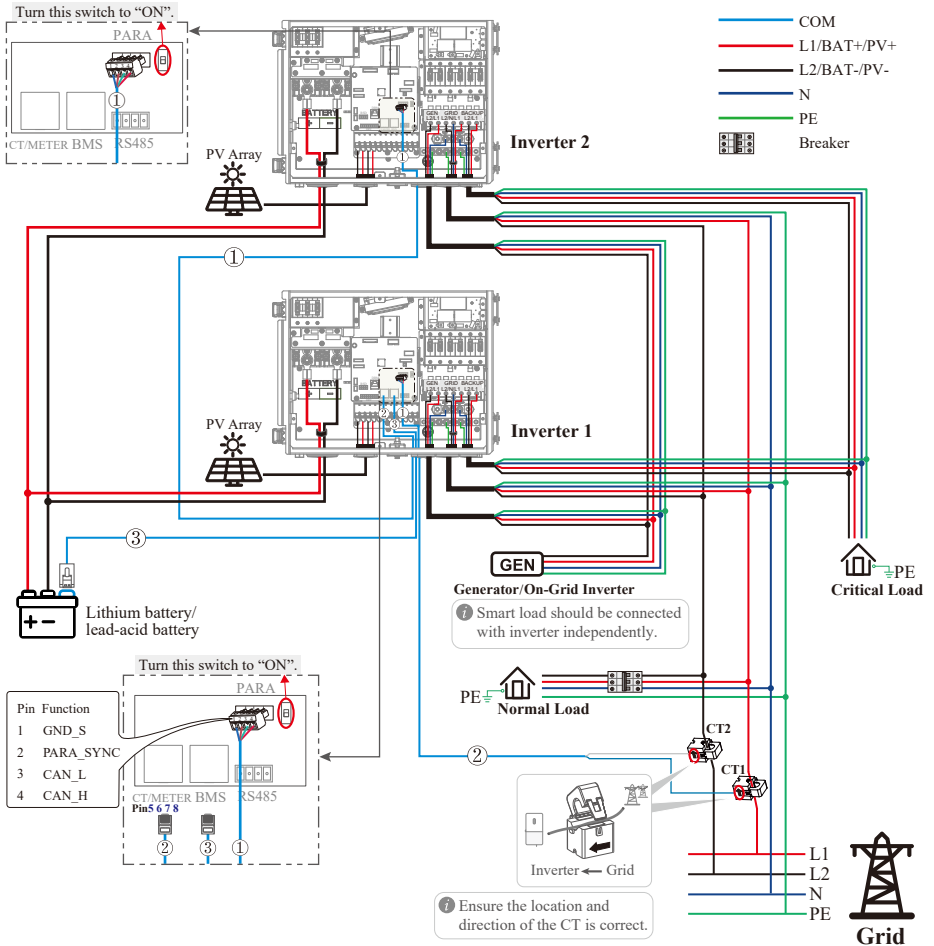

- ① Parallel communication connection
- ② CT communication connection
- ③ BMS communication connection

- * CT and BMS communication cables can be connected to any inverter of the parallel system, but they must be inserted into the same inverter and this inverter will be inverter 1.
- * Please refer to **Note for parallel wiring diagrams** to learn more information about this parallel diagram.
- * Please refer to the relevant sections of the manual for detailed wiring instructions.

Split Phase Parallel Connection Mode-Scheme B (2<N≤9)

Diagram 03

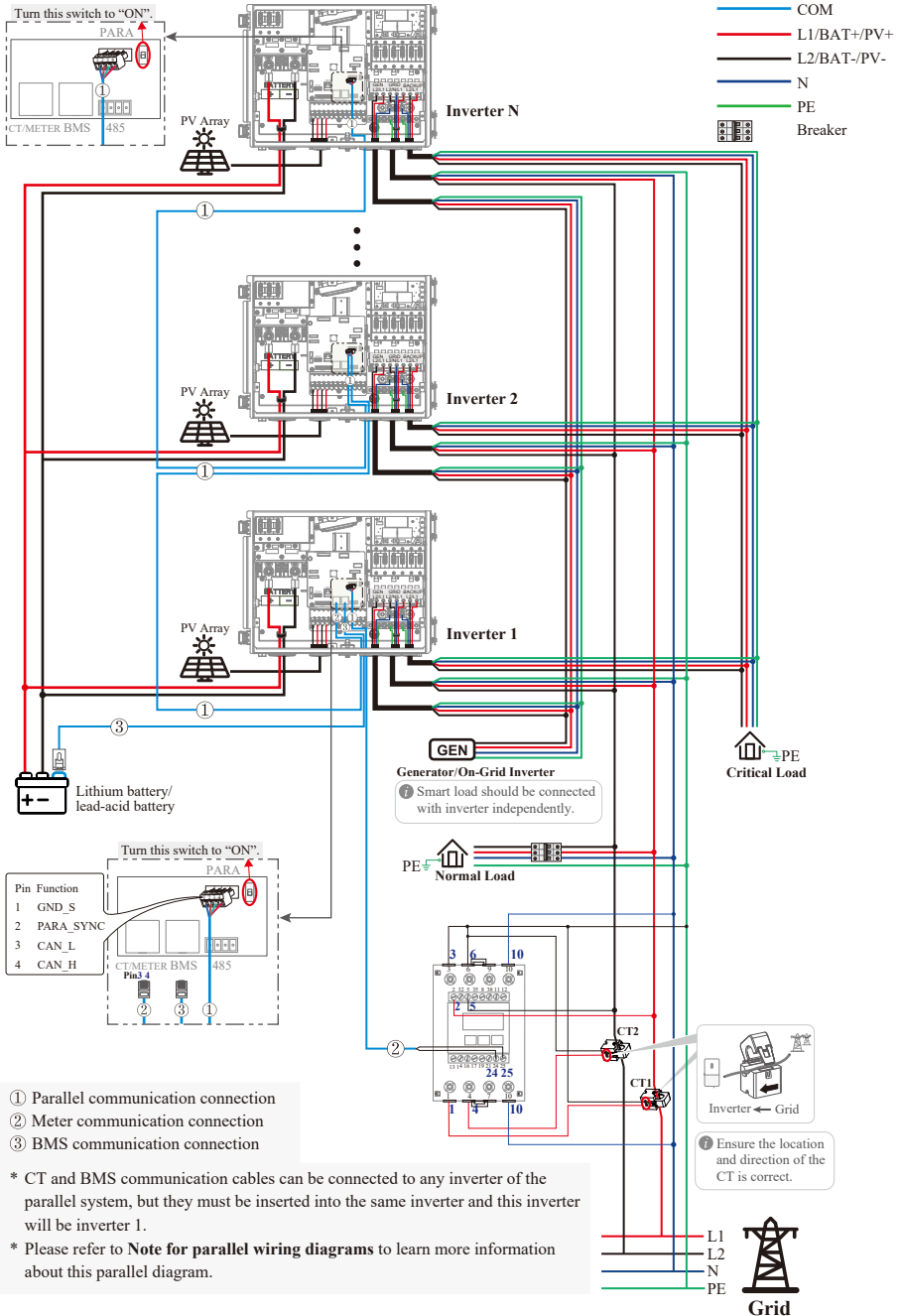

Note for parallel wiring diagrams

1. BMS communication connection is only for lithium battery.
2. It is necessary to turn the matched resistance switch (or DIP switch) of inverter 1 and inverter N to “ON” and others to “1” in parallel connection mode.
3. It is necessary to additionally purchase suitable CT and energy meter according to the specific requirements in parallel connection mode-**Scheme B** in which the CT ratio is 100:1.
4. Under parallel connection mode, it is required to connect APP to one of the inverters in the system, and then go to Console > Hybrid Setting> Other >Parallel mode to enable parallel mode on APP.
5. In one parallel system, the smart load is only allowed to be connected to GEN port in a non-parallel way.
6. The external DC/AC breakers are not supplied with the inverter and must be purchased separately. Prepare the external parallel breakers with a nominal current $\geq 2 * N * I_{max}$. (N refers to the parallel inverter quantity; I_{max} refers to the maximum output current of the inverter.)

**DANGER**

Ensure that the inverter and all cables to be installed have been completely powered off during the whole process of installation and connection. Otherwise, high voltage may result in fatal injury.

Standard Wiring Diagram
3 Parallel Inverters | 120/208V 3-Phase

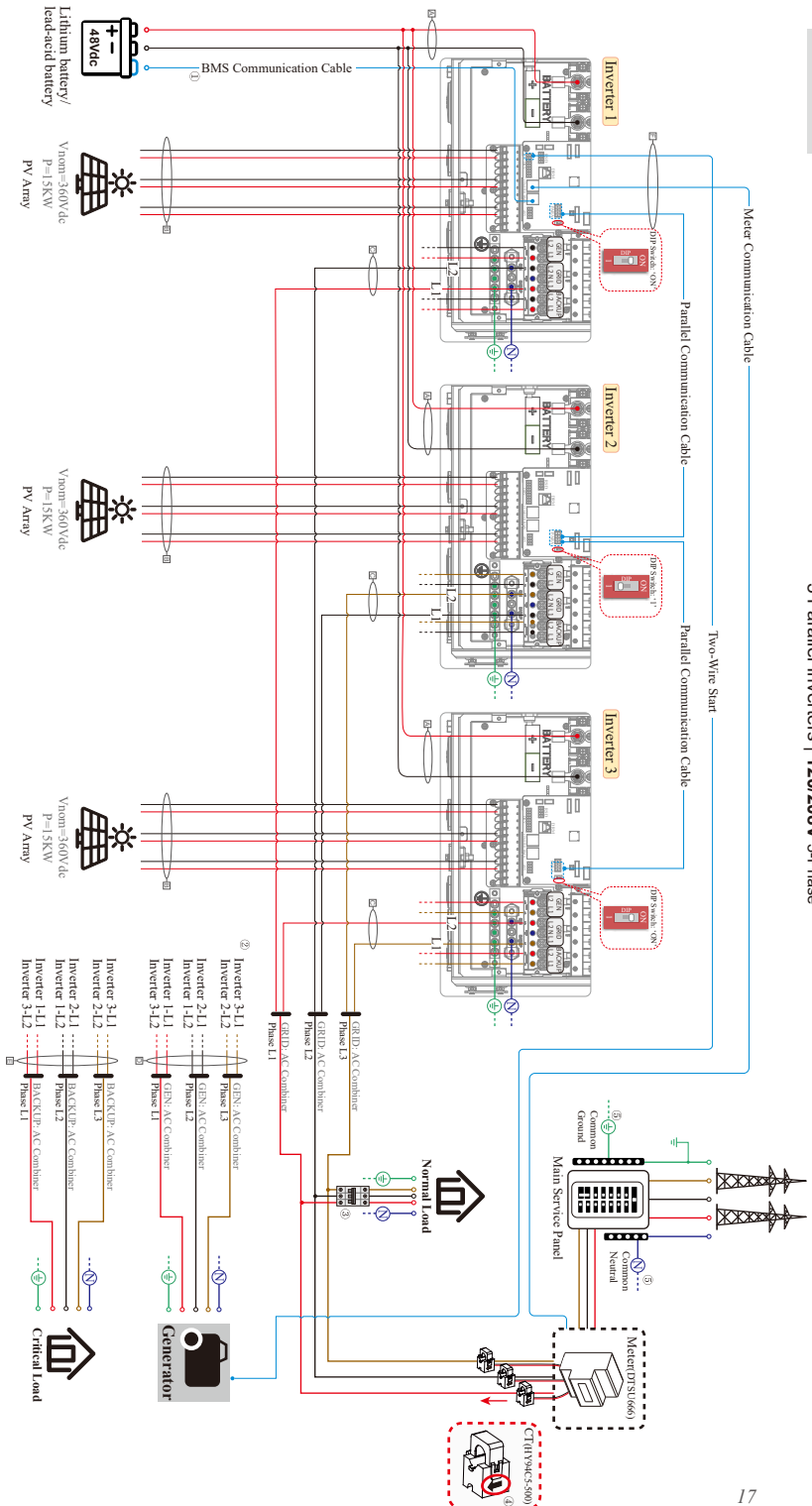

- ① (AO) L1 (DC) PV+ (DC) BAT+ (DC) BAT-
- ② (AO) L2 (DC) PV- (DC) BAT-
- ③ L3
- ④ NEUTRAL
- ⑤ GROUND
- ⑥ COM

- ① BMS is only for Lithium battery. When applying standard lithium battery connection, each inverter should be connected to BMS COM cable.
- ② The wiring method of GEN/Neutral lead is the same as that of the grid.
- ③ In Inverter L1/L2, 'N' represents inverter serial number; 'L' represents the phase of the wire in GRID/GEN/BACKUP connection.
- ④ The external DC/AC breakers are not supplied with the inverter and must be purchased separately. Refer to TABLE 1.
- ⑤ The external DC/AC breakers are not supplied with the inverter and must be purchased separately. Refer to TABLE 1.
- ⑥ These symbols represent a common neutral/ground connection.

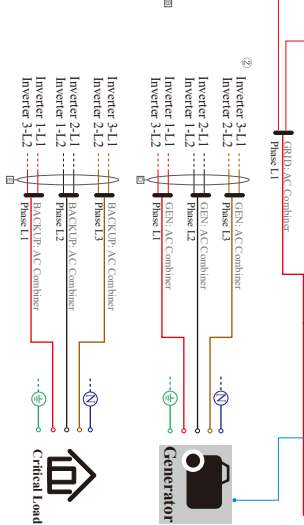

TABLE 1

LOCATION	SPECIFICATION
Battery side(DC)	300A/80V
GEN side(AC)	≥60A/250V
Grid side(AC)	≥60A/250V
Backup side(AC)	≥60A/250V
Normal load side(AC)	

TABLE 2

WIRE GAUGE GUIDE (COPPER)	CONDUCTOR
A	3/8 AWG
B	10-8 AWG
C	Min. 6 AWG
D	Min. 6 AWG
E	Min. 6 AWG
F	24-23 AWG CAT6

Note:

1. Before three-phase connection, please make sure all inverters in parallel have the same firmware version by verifying the 'DSP', 'CSB', and 'DC-DC converter' version numbers on App, as shown in *Figure 4-1*. It is recommended to reset the firmware before the three-phase connection to ensure the same parameter setting for each inverter, as shown in *Figure 4-2*.

- Verify version number: (Admin account) Console > Maintenance > Basic information
- Restore the firmware: (Admin account) Console > Maintenance > Maintaining (Factory data reset)



Figure 4-1 Basic information

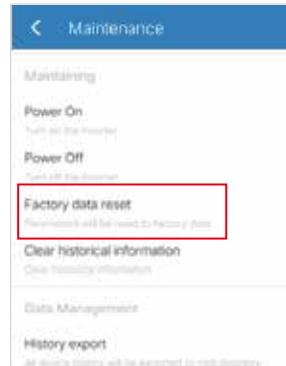

Figure 4-2 Maintaining

2. Detailed connection steps of each port have been illustrated in the following sections of this chapter, please read carefully.

3. BMS connection is only applicable to lithium battery.

- For shared lithium battery connection, please refer to diagram 04 to connect the BMS communication cable.
- For standalone lithium battery connection, the BMS communication cable needs to be connected to each inverter.

App setting guide for three-phase connection

Under three-phase connection mode, it is necessary to connect the APP to each inverter and set related parameters by following the steps below.

1. Login as an administrator: Console > Access Management > Change User > Login as administrator.
2. Go to Console > Other Setting > Grid Voltage type to select the correct phase type: UL 2/3 Phase (120V/208V). (*Figure 4-3*)
3. Go to Console > Hybrid Setting > Other to enable parallel mode, and then select the appropriate battery connection type and phase position. All inverters in the system should be configured with these parameters, as shown in *Figure 4-4--4-6*.
4. Go to Quick setup to set the basic parameters of the inverter. Detailed setting process can be found in [Quick setting at Chapter 7.2.3](#).
5. Set power control: Go to Console > Power Limit > Power control > Digital Power Meter. (*Figure 4-7*)
6. Set power derating control mode: Go to Console > Power Limit > Power derating control mode > Independent phase power. (*Figure 4-8*)

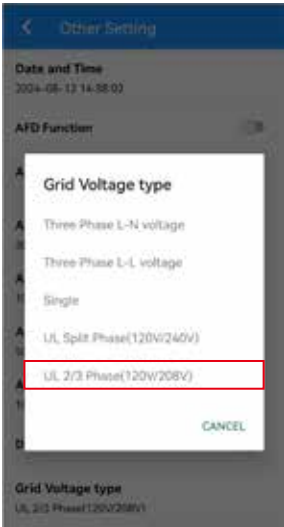

Figure 4-3 Grid Voltage type

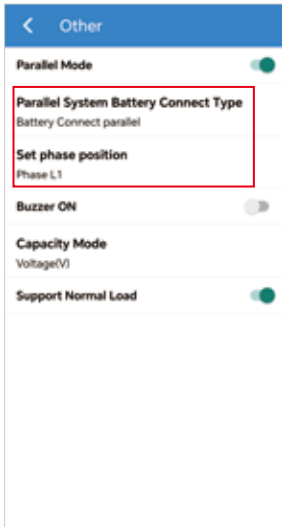

Figure 4-4 Inverter 1-Phase L1

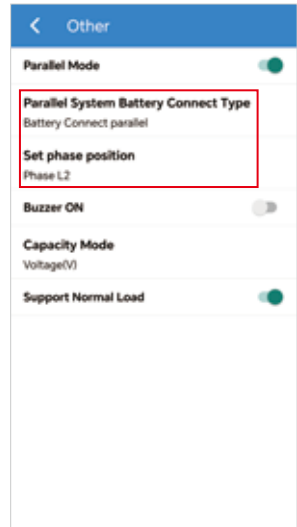

Figure 4-5 Inverter 2-Phase L2

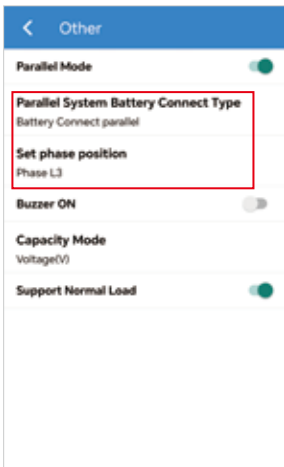

Figure 4-6 Inverter 3-Phase L3

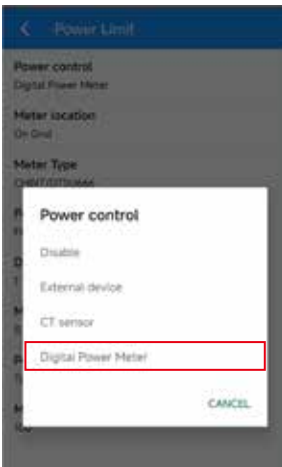

Figure 4-7 Power control

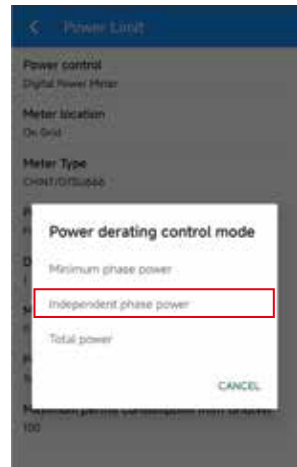

Figure 4-8 Power derating control mode

Standard Wiring Diagram
2 Parallel Inverters | 120/208V 3-Phase

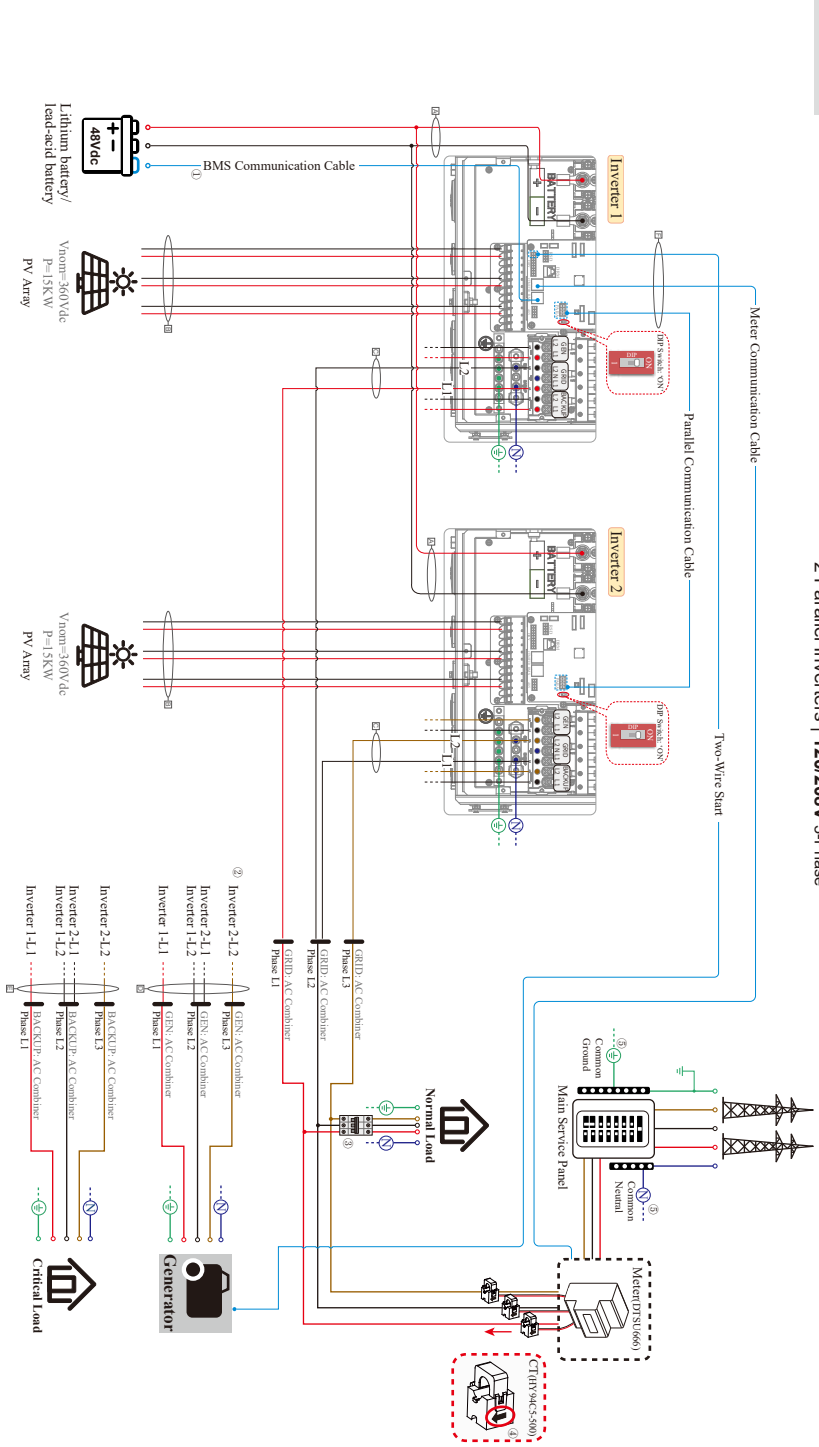

TABLE 1

LOCATION	SPECIFICATION
Battery side(DC)	300A/80V
GEN side(AC)	≥60A/250V
Grid side(AC)	≥60A/250V
Backup side(AC)	≥60A/250V
Normal load side(AC)	Depends on required phase through inverter and the load device.

TABLE 2

WIRE GAUGE (COPPER)	CONDUCTOR
A	3.0 AWG
B	10.8 AWG
C	Min. 6 AWG
D	Min. 6 AWG
E	Min. 6 AWG
F	24-23 AWG CAT6

TABLE 1

LOCATION	SPECIFICATION
Battery side(DC)	300A/80V
GEN side(AC)	≥60A/250V
Grid side(AC)	≥60A/250V
Backup side(AC)	≥60A/250V
Normal load side(AC)	Depends on required phase through inverter and the load device.

TABLE 2

WIRE GAUGE (COPPER)	CONDUCTOR
A	3.0 AWG
B	10.8 AWG
C	Min. 6 AWG
D	Min. 6 AWG
E	Min. 6 AWG
F	24-23 AWG CAT6

Note:

- Before three-phase connection, please make sure all inverters in parallel have the same firmware version by verifying the 'DSP', 'CSB', and 'DC-DC converter' version numbers on App, as shown in *Figure 4-1*. It is recommended to reset the firmware before three-phase connection to ensure the same parameter setting for each inverter, as shown in *Figure 4-2*.
 - Verify version number: (Admin account) Console > Maintenance > Basic information.
 - Restore the firmware: (Admin account) Console > Maintenance > Maintaining (Factory data reset).
- Detailed connection steps of each port have been illustrated in the following sections of this chapter, please read carefully.
- BMS connection is only applicable to lithium battery.
 - For shared lithium battery connection, please refer to diagram 05 to connect the BMS communication cable.
 - For standalone lithium battery connection, the BMS communication cable needs to be connected to each inverter.

App setting guide for three-phase connection

Under three-phase connection mode, it is necessary to connect the APP to each inverter and set related parameters by following the steps below.

- Login as an administrator: Console > Access Management > Change User > Login as administrator.
- Go to Console > Other Setting > Grid Voltage type to select the correct phase type: UL 2/3 Phase (120V/208V). (*Figure 4-3*)
- Go to Console > Hybrid Setting > Other to enable parallel mode, and then select the appropriate battery connection type and phase position. All inverters in the system should be configured with these parameters, as shown in *Figure 4-9&4-10*.
- Go to Quick setup to set the basic parameters of the inverter. Detailed setting process can be found in [Quick setting at Chapter 7.2.3](#).
- Set power control: Go to Console > Power Limit > Power control > Digital Power Meter. (*Figure 4-7*)
- Set power derating control mode: Go to Console > Power Limit > Power derating control mode > Independent phase power. (*Figure 4-8*)

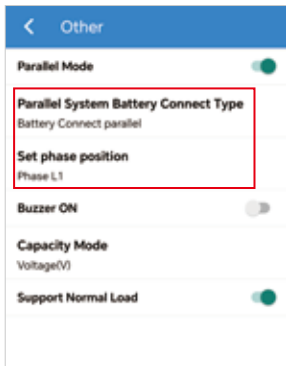

Figure 4-9 Inverter 1-Phase L1

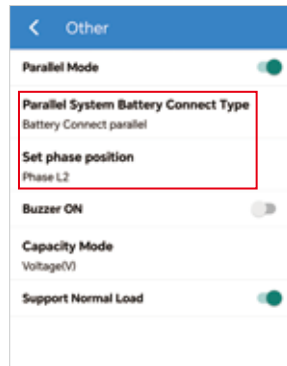

Figure 4-10 Inverter 2-Phase L2

4.2 Removing Insulation Cover and Grounding Cable

A shielding cover has been installed over the wiring box of the ESS inverter to protect users from potential electrical injuries. Before removing the cover and wiring, please ensure that the inverter and all cables to be installed have been completely powered off during the whole process of installation and connection.

Procedures:

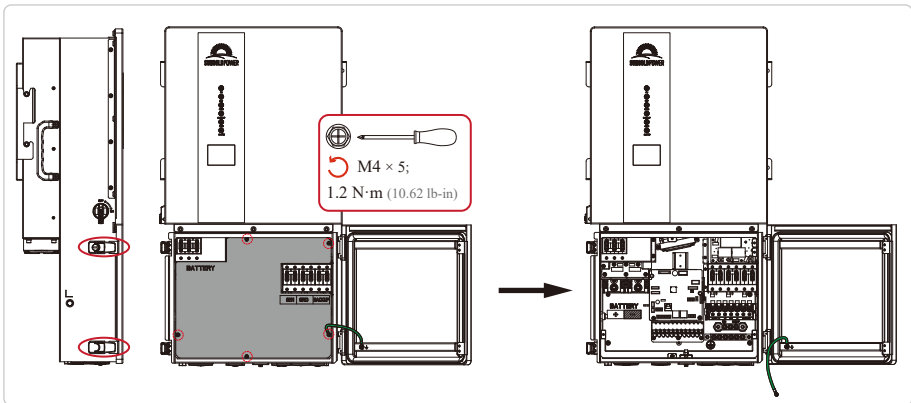

1. Open the side locks of the inverter.
2. Remove the screws of the insulation cover and remove the grounding cable with a torque of 1.2 N·m or 10.62 lb-in.



CAUTION

After the electrical connections are complete, if no other connections are made in the wiring area, replace the insulation cover and ensure the grounding cable is well-connected again.

4.3 Internal Grounding

 WARNING	The inverter must be grounded; otherwise, there will be an electric shock risk.
 CAUTION	If the positive pole or negative pole of the PV array is required to be grounded, the inverter output (to AC grid) must be isolated by transformer in accordance with IEC62109-1, -2 standards.

A protective earth (PE) busbar is equipped inside of the inverter’s wiring box. Please be sure to connect the PE cable to the PE busbar for reliable grounding.

A minimum gauge size of AWG 8 green or green-yellow wire is recommended.

Terminals Overview

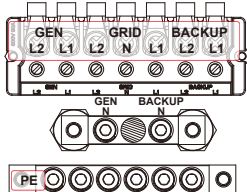



Items	Remark
PE cable size	Min. 8 AWG
Strip length	0.7" (18 mm)
Screw	M6
Torque	35 lb-in

Procedures:

1. Thread the wires into wiring box through AC connection ports, namely Grounding/ GRID/BACKUP/GEN connection ports.
2. As shown in the illustrations, attach the PE cable to the busbar accordingly, and tighten terminal screws with a torque of 3.95 N·m or 35 lb-in.
3. Make sure that all cables are securely in place.

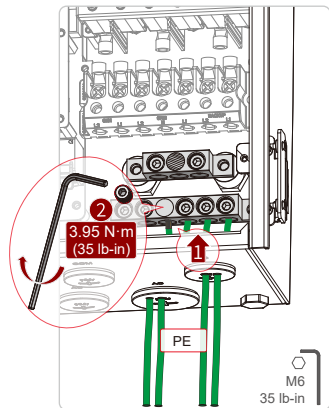

4.4 GRID/BACKUP/GEN Connection

This section explains the requirements and procedures of AC connection. Read carefully before connecting.

 DANGER	Before connecting the GRID/BACKUP/GEN terminal, ensure that both the AC terminal and the DC terminal are powered off and the PV switch is OFF. Otherwise there is a risk of high voltage shock.
---	---

Procedures:

1. Prepare the proper cable we recommended as shown below, and strip an appropriate length of the cable insulation. It is recommended to use outdoor dedicated cables.

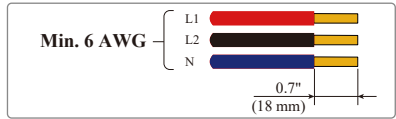

2. Thread the wires into wiring box through AC ports.

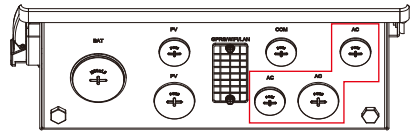

3. As shown in the figure below, insert the wire into the terminal according to the label on the terminal block, and then tighten the terminal screws with a torque of 3.95 N·m or 35 lb-in. Finally, ensure that all wires are securely in place.

- * When connecting the L1/L2/N cables to the GRID terminals, thread an AC toroid through these three cables first.
- * AC cable connection ports in the illustrations are for reference only. Select appropriate ports as needed.

AC Toroid Dimension:

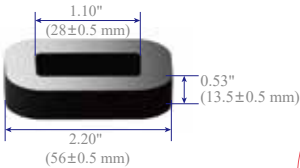

Case Dimension		
a (mm)	14.00	±0.5
b (mm)	28.00	±0.5
c (mm)	20.00	±0.5
d (mm)	13.50	±0.5
e (mm)	56.00	±0.5
f (mm)	48.00	±0.5

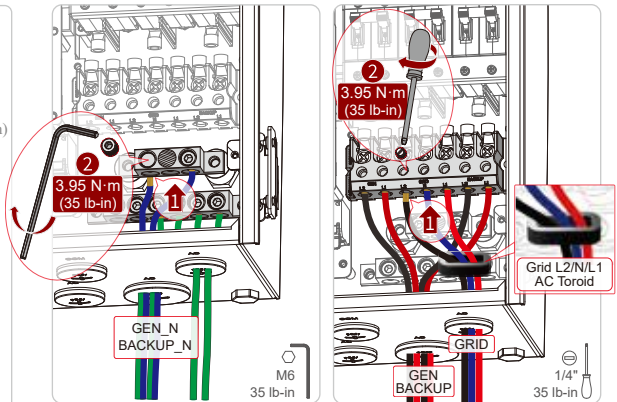

4.5 PV Connection

This section explains the requirements and procedures of PV connection. Read carefully before connecting.

 DANGER	<ol style="list-style-type: none">1. Photovoltaic arrays exposed to sunlight will generate dangerous voltages!2. Before connecting the PV terminal, ensure that both the AC terminal and the DC terminal are powered off and the PV switch is OFF. Otherwise there is a risk of high voltage shock.
---	--

Procedures:

1. Prepare the proper cable we recommended as shown below, and strip an appropriate length of the cable insulation. It is recommended to use outdoor dedicated PV cables.

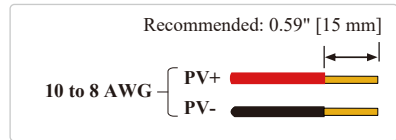

2. Inspection before connection.

- Check correct polarity of wire connection from PV modules and PV input connectors.
- The test voltage cannot exceed 600 V DC.
- Ensure that the PV switch is OFF.

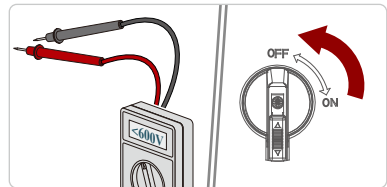

3. Thread the wires into wiring box through PV connection ports.

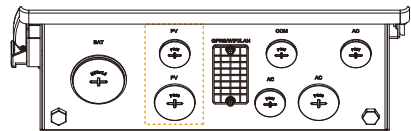

4. Open the switches of PV input connector. Insert the stripped cable into the PV input connector. When doing so, ensure that the stripped cable and the PV input connector are of the same polarity. Finally, close switches and ensure the wires are tightly fixed.

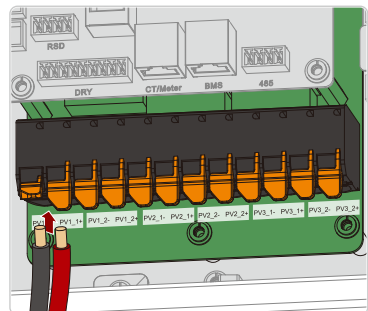

4.6 Battery Connection

This section explains the requirements and procedures of battery connection. Read carefully before connecting.

 DANGER	Before connecting the battery terminal, ensure that both the AC terminal and the DC terminal are powered off and the PV switch is OFF. Otherwise there is a risk of high voltage shock.
---	---

Procedures:

1. Prepare the proper cable and OT terminal we recommended as shown below, and strip an appropriate length of the cable insulation. It is recommended that the battery cable be less than or equal to 3 m.

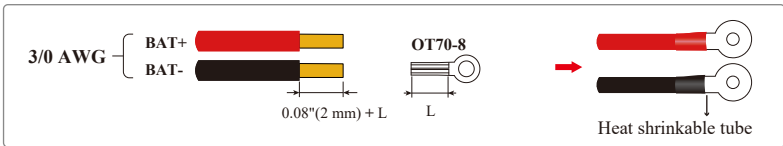

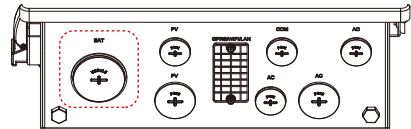

2. Thread the wires into wiring box through BAT connection port.



3. Insert the wires into battery terminals. A toroid is a must for our inverter to avoid interference.

 WARNING	Reverse polarity will damage the inverter!
---	--

	M8
	Max. 20 N·m (177.01 lb-in)

DC Toroid Dimension:

Case Dimension		
OD (mm)	63.55	±0.7
ID (mm)	36.57	±0.7
HT (mm)	24.40	±0.7

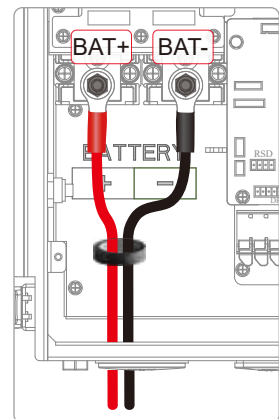

4.7 Communication Connection

There are communication interfaces in the communication port on the bottom of the inverter as show below :

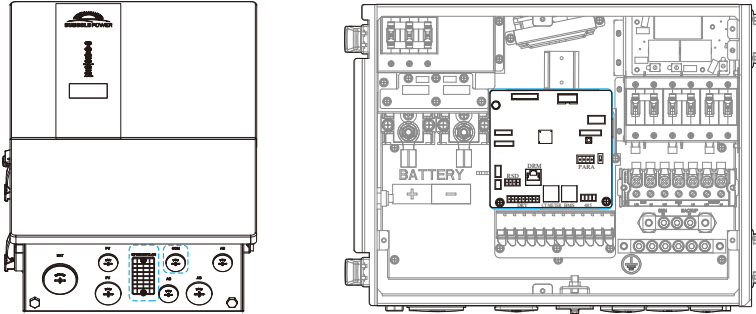

Interface		Descriptions
PARA		4-Pin interface for parallel communication
		A matched resistance switch for parallel communication
485		4-Pin interface for RS485 communication
DRM		Demand response mode for Australia application
CT/METER		For CT/Meter communication or Grid current sense
BMS		Lithium battery communication interface
9-Pin	GEN	Generator control
	NTC	Temperature sensor terminal of lead-acid battery
	RMO	Remote off control
	DRY	DI/DO control
RSD		RSD control interface
GPRS/WIFI/LAN		For GPRS/WIFI/LAN communication

4.7.1 BMS Connection (Only for Lithium Battery)



NOTE

This manual ONLY illustrates the pinout sequence of BMS at INVERTER SIDE. For details about the pinout sequence at battery side, see the user manual of the battery you use, and the following pinout diagram of battery side is only for illustration.

• **Standard RJ45 Pinout**

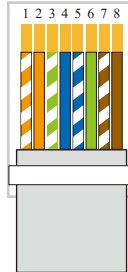
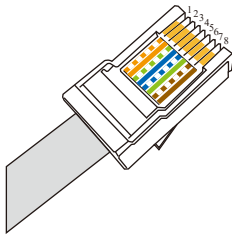

RJ45 Pin Configuration	
Pin	Color
1	White-Orange
2	Orange
3	White-Green
4	Blue
5	White-Blue
6	Green
7	White-Brown
8	Brown

Always face the flat side of the terminal, and count the pin slots from left to right from 1 to 8. Read the pin definitions of both the battery and inverter carefully.

• **Pin definition of terminal**

INVERTER:

Inverter	
Pin	Definition
1	/
2	/
3	/
4	CAN_H
5	CAN_L
6	/
7	/
8	/

BATTERY:

Taking one battery's pin configuration as an example.

Battery Example	
Pin	Definition
1	/
2	/
3	/
4	CAN_H
5	CAN_L
6	GND
7	/
8	/

• **CAN BUS connection principle**

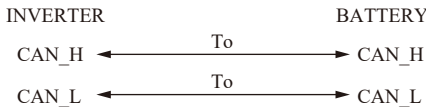

• BMS communication cable preparation:

- ① Prepare RJ45 terminals and strip appropriate length of COM cables.
- ② According to pin definitions and cable order, assemble the RJ45 terminals and crimp communication wires. There are two methods to assemble the RJ45 terminals.
- ③ Then label the RJ45 terminals (BAT or INV) to avoid confusion.
- ④ After finishing wire-making, use a multimeter or other specific tool to check if your cable is good, bad, or wired incorrectly.

Method 1: Use the INVERTER RJ45 pinout as the standard pinout to crimp wires, then the battery side will be a non-standard one (special pinout). Cut off the other no-used wires (1/2/3/6/7/8) for the battery RJ45 terminal.

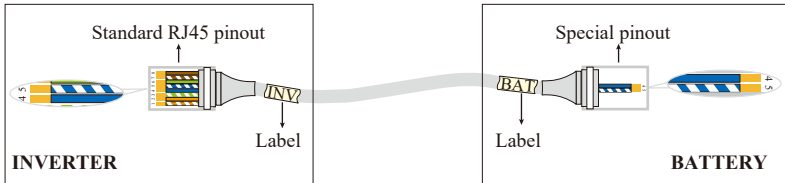

Method 2: Use the BATTERY RJ45 pinout as the standard pinout to crimp wires, then the inverter side will be a non-standard one (special pinout). Cut off the other no-used wires (1/2/3/6/7/8) for the inverter RJ45 terminal.

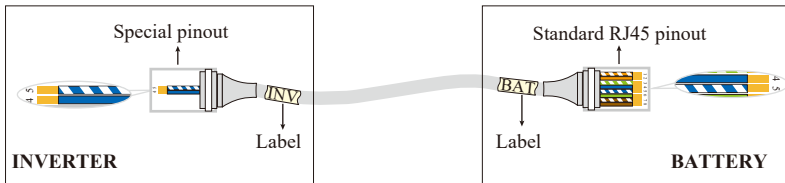

• BMS communication cable connection steps:

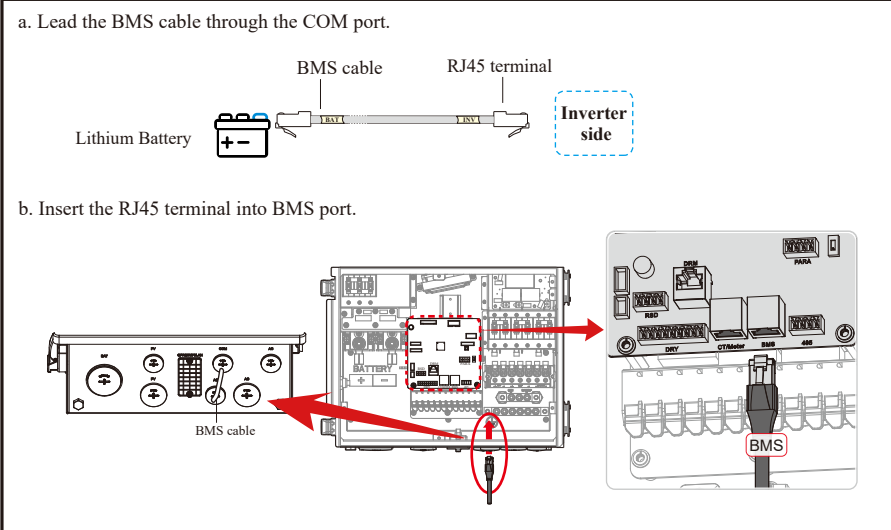

4.7.2 CT/Meter Connection

A CT/Meter is applied to monitor electricity usage of all loads.

• **RJ45 Terminal Configuration for CT and Meter Communication**

PIN	1	2	3	4	5	6	7	8
Function Description	/	/	RS485_A	RS485_B	CT2-	CT2+	CT1+	CT1-

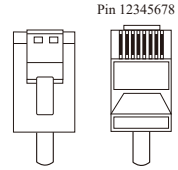

Note: The Standard RJ45 Pinout Color in BMS Connection section is also applicable to this part .

• **Cable connection overview**

CT:

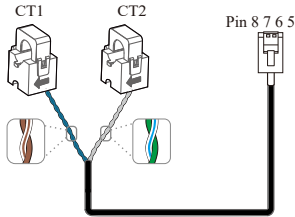

RJ45	RJ45 Pinout Color	CT Cable Color
Pin5(CT2-)	White-Blue	White
Pin6(CT2+)	Green	
Pin7(CT1+)	White-Brown	Blue
Pin8(CT1-)	Brown	

Meter+CT:

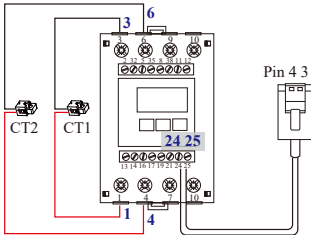

RJ45	Meter
Pin3(RS485_A)	Pin24
Pin4(RS485_B)	Pin25

Meter+CT (for 3-phase connection only):

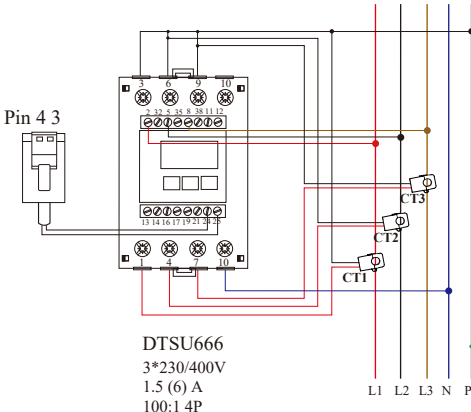

RJ45	Meter
Pin3 (RS485_A)	Pin24
Pin4 (RS485_B)	Pin25

Meter	CT	Other Wiring
Pin1	CT1+	/
Pin3	CT1 -	PE
Pin4	CT2+	/
Pin6	CT2 -	PE
Pin7	CT3+	/
Pin9	CT3 -	PE
Pin2	/	L1
Pin5	/	L2
Pin8	/	L3
Pin10	/	N

• **CT/Meter communication cable connection steps:**

a. Make the RJ45 terminal according to above function description of each Pin definition.

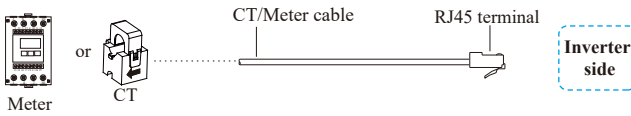

b. Lead the CT/Meter cable through the COM port. And insert the RJ45 terminal into CT/METER port.

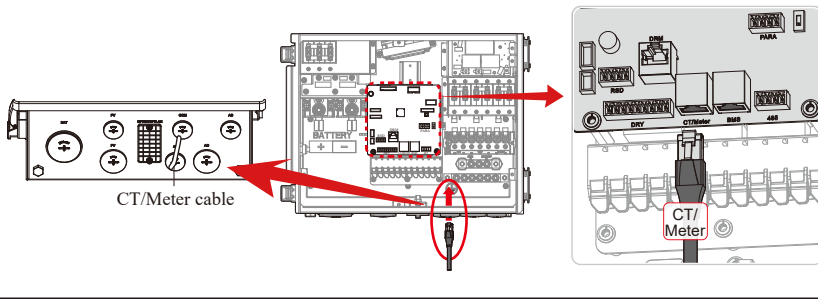

4.7.3 RS485 Connection

- 4-Pin Terminal Configuration of RS485 Communication

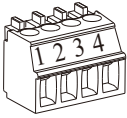

PIN	1	2	3	4
Function Description	RS485_A	RS485_B	PE	PE

- RS485 communication cable connection steps:

a. Make the 4-Pin terminal according to above function description of each Pin definition.

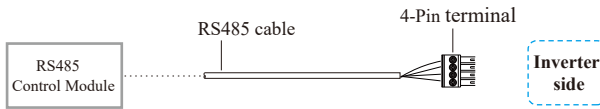

b. Lead the RS485 cable through one COM port. And insert the 4-Pin terminal into RS485 port on inverter panel.

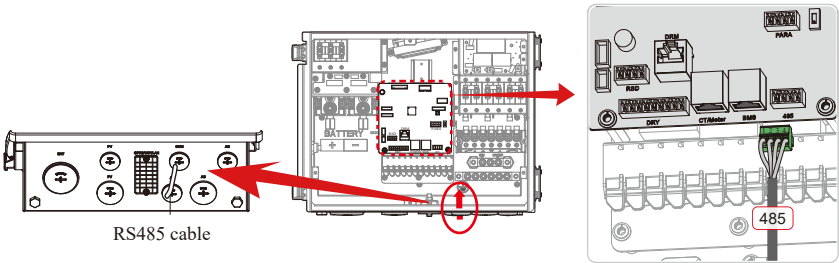

4.7.4 Parallel Communication Connection

- 4-Pin Terminal Configuration of parallel Communication

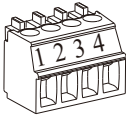

PIN	1	2	3	4
Function Description	GND_S	PARA_SYNC	CAN_L	CAN_H

- Parallel communication cable connection overview

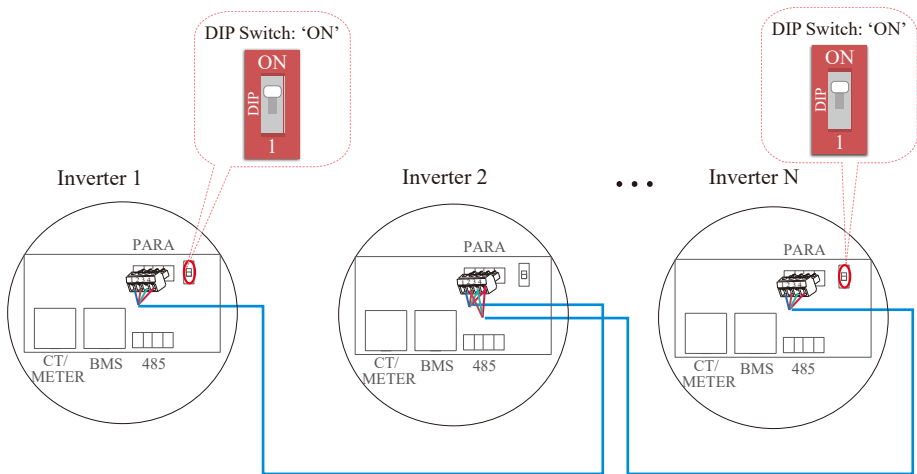

It is necessary to turn the matched resistance switch of inverter 1 and inverter N to “ON” in parallel connection mode.

Inverter 1	Inverter 2	...	Inverter N
Pin4 (CAN_H)	Pin4 (CAN_H)		Pin4 (CAN_H)
Pin3 (CAN_L)	Pin3 (CAN_L)		Pin3 (CAN_L)
Pin2 (PARA_SYNC)	Pin2 (PARA_SYNC)		Pin2 (PARA_SYNC)
Pin1 (GND_S)	Pin1 (GND_S)		Pin1 (GND_S)

• **Parallel communication cable connection steps:**

a. Make the 4-Pin terminal according to above function description of each Pin definition.

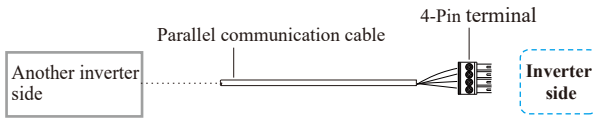

b. Lead the Parallel communication cable through one COM port. And insert the 4-Pin terminal into PARA port.

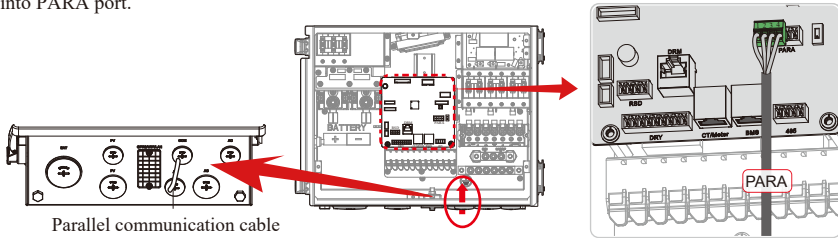

4.7.5 NTC/RMO/DRY Connection(s)

• **9-Pin Terminal Configuration of Auxiliary Communication**

Pin 123456789

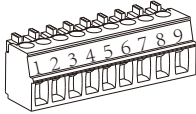

PIN	Function Description
1	GEN Control
2	GEN Control
3	NC1 (Normal Close)
4	NO2 (Normal Open)
5	N2
6	NC2 (Normal Close)
7	REMO OFF
8	GND S (NTC BAT)
9	NTC BAT+

• **NTC/RMO/DRY communication cable connection steps:**

a. Make the 9-Pin terminal according to above function description of each Pin definition for the auxiliary port you want to use.

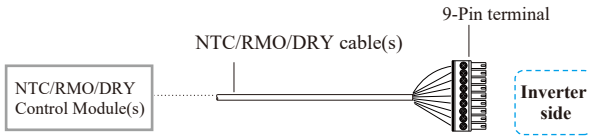

b. Lead the NTC/RMO/DRY cable(s) through one COM port. And insert the 9-Pin terminal into DRY port.

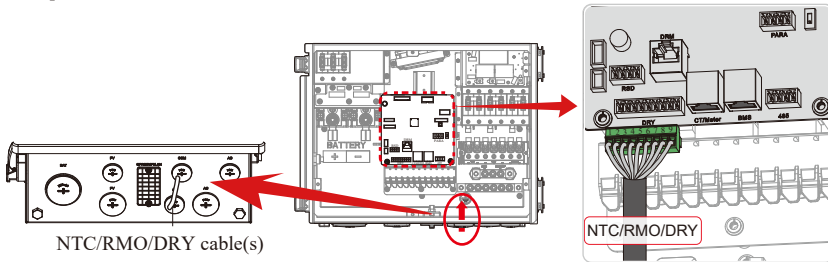

4.7.6 RSD Connection(s)

- 4-Pin Terminal Configuration of RSD

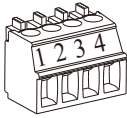

PIN	3	4
Function Description	Emergency Stop Signal Button	

- Emergency Stop Signal:

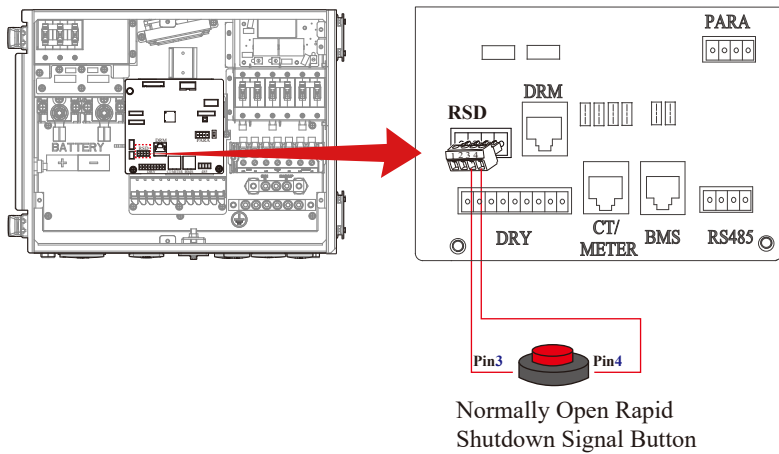

- RSD connection steps:

a. Make the 4-Pin terminal according to above function description of each Pin definition.

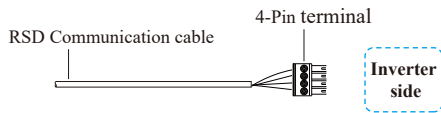

b. Lead the RSD Communication cable through one COM port. And insert the 4-Pin terminal into RSD port.

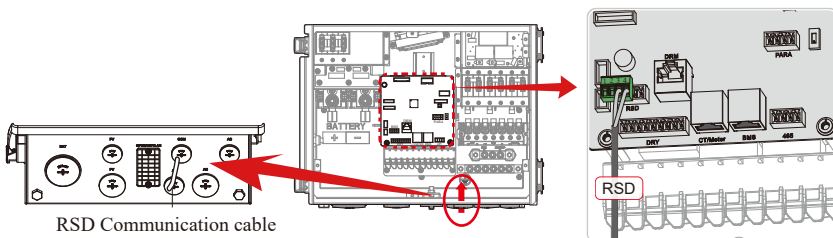

4.7.7 GPRS/WIFI/LAN Module Connection (Optional)

For details, please refer to the corresponding Module Installation Guide in the packing.

The appearance of module may be slightly different. The figure shown here is only for illustration.

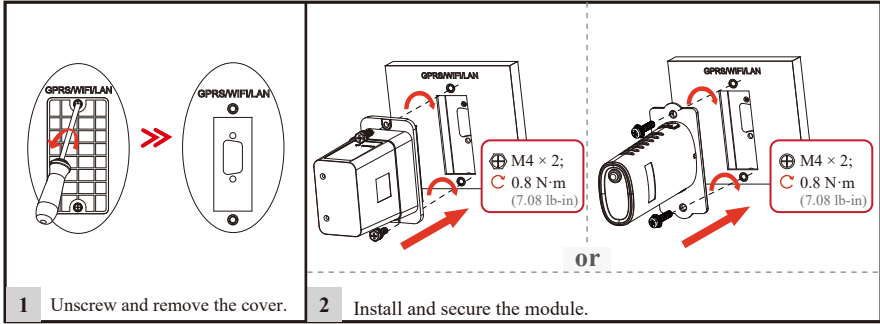

5 System Operation

5.1 Inverter Working Mode

The inverter supports several different working modes.

5.1.1 Self-consumption Mode

Go to the "Hybrid Setting" menu, and select the "Self-consumption mode".

Under Self-consumption mode, the priority of PV energy consumption will be Load > Battery > Grid, that means the energy produced by PV gives priority to powering local loads, the excess energy is used to charge the battery and the remaining energy is fed into the grid.

This is the default mode to increase self-consumption rate. There are several situations of self-consumption working mode based on PV energy.

a) Wealthy PV Energy

When PV energy is wealthy, the PV energy will be first consumed by loads, the excess energy will be used to charge the battery and then the remaining energy will be fed into the grid.

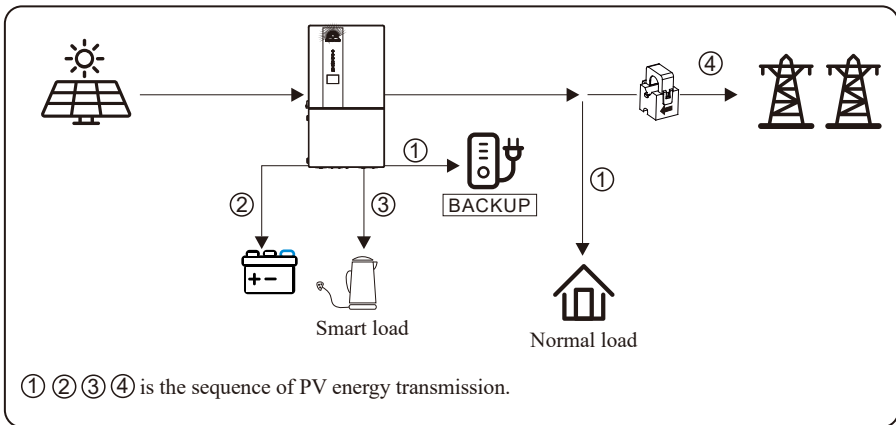

b) Limited PV Energy

When the PV energy is not enough to cover all consumption, the PV energy will be entirely used by loads, and the insufficient part will be supplied by battery. Then still insufficient parts will be supplied by grid.

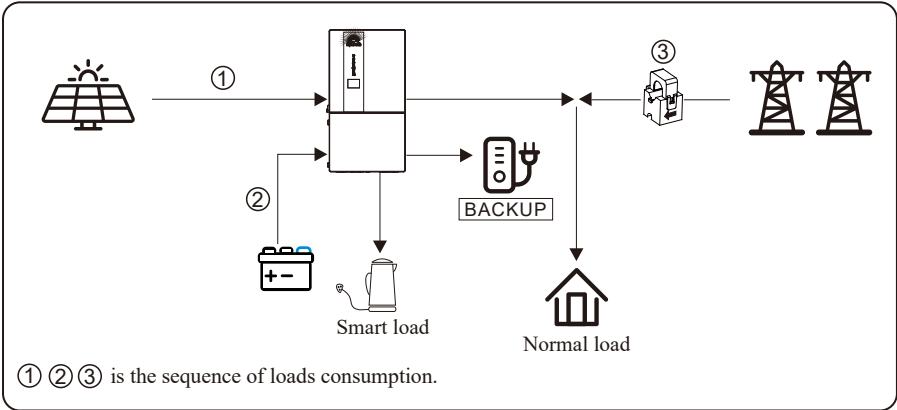

c) No PV Input

The inverter will first discharge the battery energy for home load consuming when no PV input, such as in the evening or some cloudy or rainy days. If the demand is not met, the loads will consume grid energy.

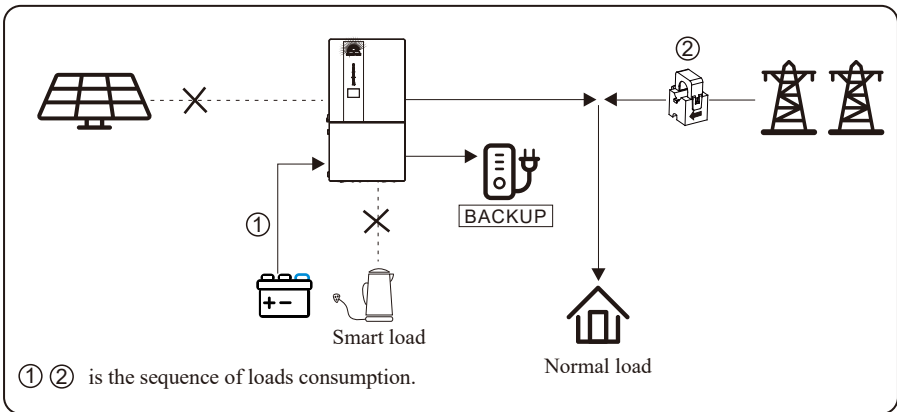

5.1.2 Feed-in Priority Mode

Go to the "Hybrid Setting" menu, and select the "Feed-in priority mode".

Under this mode, the priority of PV energy consumption will be Load > Grid > Battery, that means the energy produced by PV gives priority to powering local loads, the excess energy is fed into the grid, and the remaining energy is used to charge the battery.

a) Wealthy PV Energy

When PV energy is wealthy, the PV energy will be first consumed by loads. If there is excess PV power, the power will be fed into grid. If there is still PV energy left after load consuming and grid feeding, then the remaining PV power will be used to charge the battery.

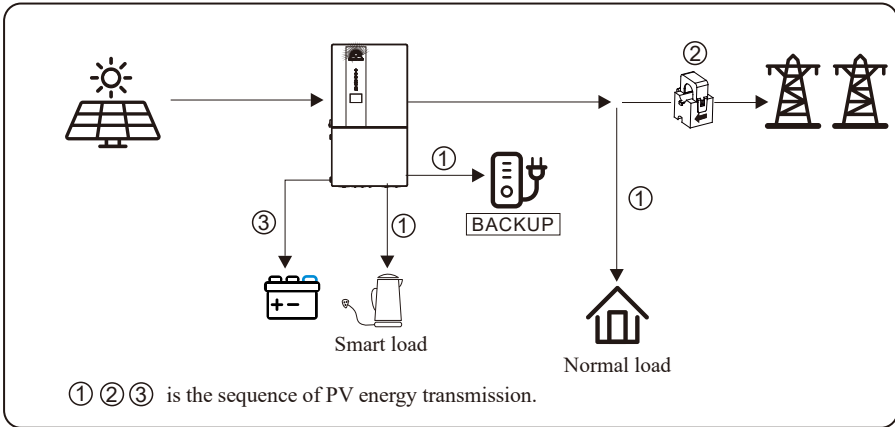

b) Limited PV Energy

When PV energy is limited and can not meet the feed-in grid power, the battery will discharge to meet it.

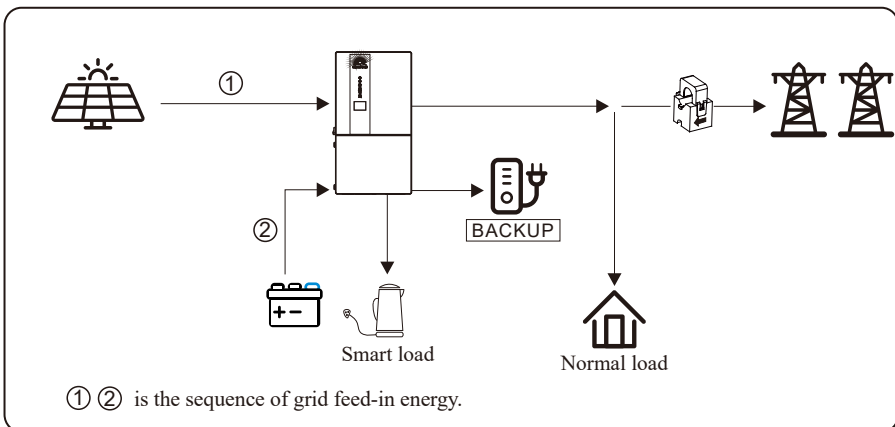

c) No PV Input

The inverter will first discharge the battery energy for home load consuming when no PV input, such as in the evening or some cloudy or rainy days. If the demand is not met, the loads will consume the grid energy.

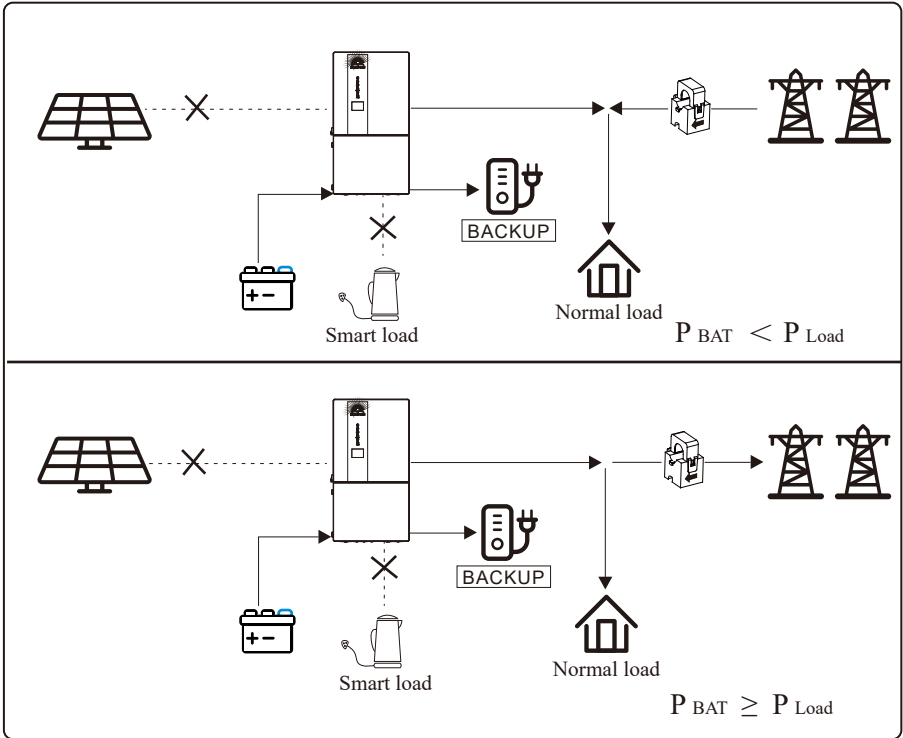

5.1.3 Back-up Mode

Go to the "Hybrid Setting" menu, and select the "Back-up Mode".

Under this mode, the priority of PV energy consumption will be Battery > Load > Grid.

This mode aims at charging the battery quickly, and at the same time, you can choose whether to allow AC to charge the battery.

Forbid AC charging

In this mode, the battery can be charged only with PV power, and the charging power varies with PV power.

a) Wealthy PV energy

When PV energy is wealthy, PV charges the battery first, then meets the load, and the rest is fed into the grid.

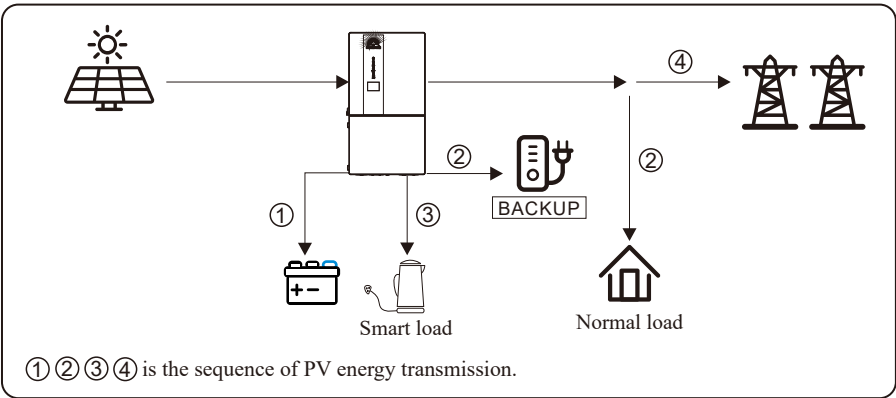

b) Limited PV energy

When PV energy is limited, PV gives priority to charging the battery, and the grid directly meets the load demand.

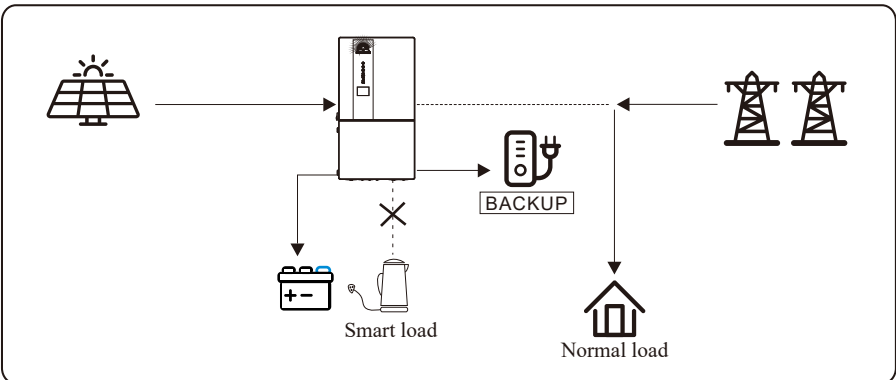

Allow AC charging

In this situation, the battery can be charged both with PV and AC.

a) Wealthy PV energy

When PV energy is wealthy, PV charges the battery first, then meets the loads, and the rest is fed into the grid.

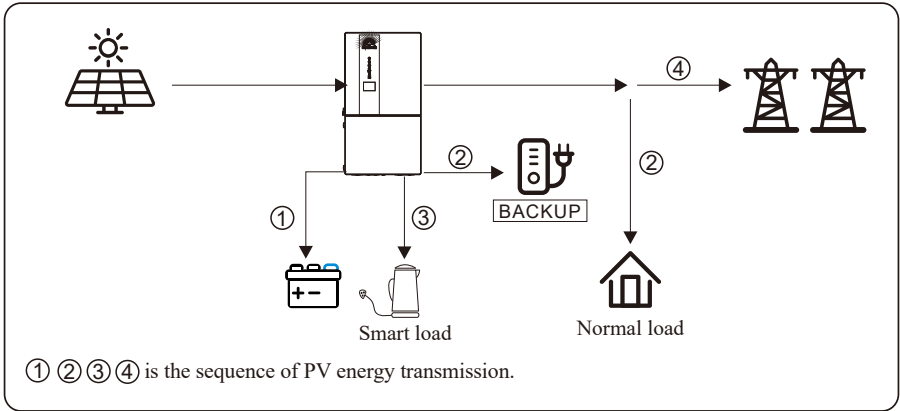

b) Limited PV energy

When the PV energy is not enough to charge the battery, the grid energy will charge the battery as supplement. Meanwhile, the grid energy is consumed by loads.

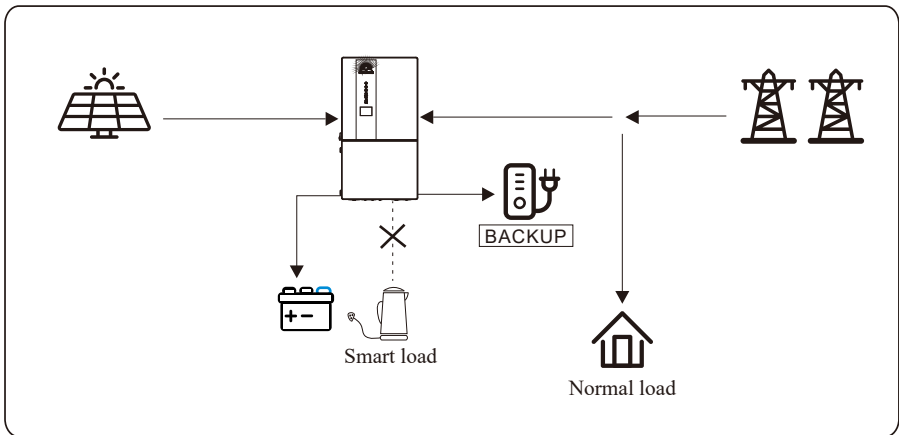

5.1.4 Forced Charge/Discharge Function

According to the demands of application, the user can set the inverter to work on forced charge/discharge the battery in any working mode.

There are three time periods in which you can set this function. Outside of the set periods, the inverter returns to its original working mode. The forced charge/discharge function has the highest priority.

The relationship between the forced charge/discharge function and working mode shown as below.

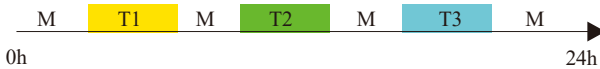

M : Self-consumption Mode/Feed-in Priority Mode/Back-up Mode

T1: Time period 1 for forced charge/discharge parameter setting

T2: Time period 2 for forced charge/discharge parameter setting

T3: Time period 3 for forced charge/discharge parameter setting

T1, T2, and T3 priority to M.

For the detail settings, please go to Console > Hybrid Setting to enable Time-based Control on App.

5.1.5 Off Grid Mode

When the power grid is cut off, the system automatically switches to Off Grid mode.

Under off-grid mode, only critical loads are supplied to ensure that important applications continue to work without power failure. Under this mode, the inverter can't work without the battery.

a) Wealthy PV energy

When PV energy is wealthy, the PV power will be first consumed by critical load, then charge the battery.

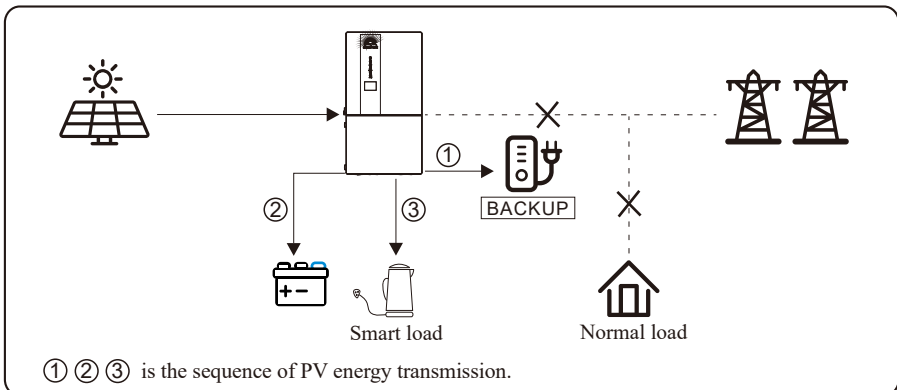

b) Limited PV energy

When PV energy is limited, BACKUP loads are first powered by PV and then supplemented by battery.

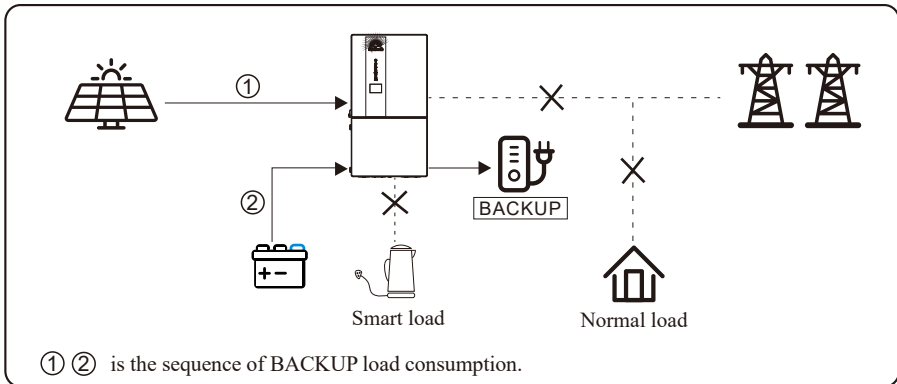

NOTICE

- Under this mode, please complete the output voltage and frequency settings.
- It is better to choose the battery capacity greater than 100 Ah to ensure BACKUP function works normally.
- If BACKUP output loads are inductive or capacitive loads, to make sure the stability and reliability of system, it is recommended to configure the power of these loads to be within 50% of BACKUP output power range.

5.2 Startup/Shutdown Procedure

5.2.1 Startup Procedure

Before starting up, check whether the installation is secure and strong enough, and whether the system has been well grounded. Then make sure the connections of AC, battery, PV etc. are correct, and confirm the parameters and configurations conform to relevant requirements.

AC Frequency	50/60 Hz	PV Voltage	70 V to 540 V
Battery Voltage	40 V to 64 V	Grid AC Voltage	120/240 V (Split phase) / 208 V (2/3 phase)

Make sure all the above aspects are right, then follow the procedures below to start up the inverter.

- 1) Power on the PV Switch.
- 2) Power on the DC breaker at BATTERY side.
- 3) Power on the AC breaker at GRID side.
- 4) Connect the cell phone App via Bluetooth. And click the Power ON in the App for the first time. Refer to Section 7.2 for details.

Or you can hold the ON/OFF button on the side of the inverter for 5s in this step when performing subsequent startup.

- 5) Power on the AC breaker at BACKUP side.

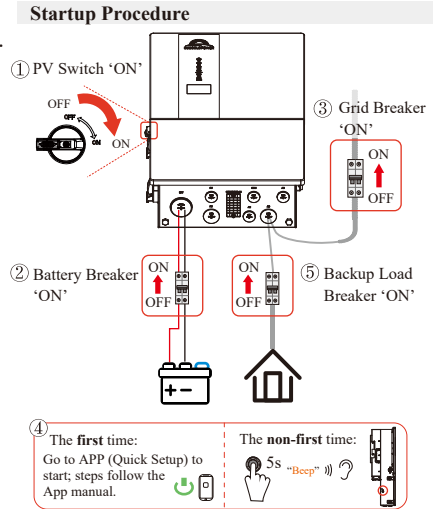

5.2.2 Shutdown Procedure

When it is necessary to shut down the running system, please follow the procedures below:

- 1) Connect the cell phone App via Bluetooth. And click the Power OFF on the App. Refer to Section 7.2 for details. Or you can hold the ON/OFF button on the side of the inverter for 5 seconds in this step when performing subsequent shutdown.
- 2) Power off the AC breaker at BACKUP side.
- 3) Power off the AC breaker at GRID side.
- 4) Power off the DC breaker at BATTERY side.
- 5) Power off the PV Switch.
- 6) To disconnect the inverter cables, please wait at least 5 minutes before touching them.

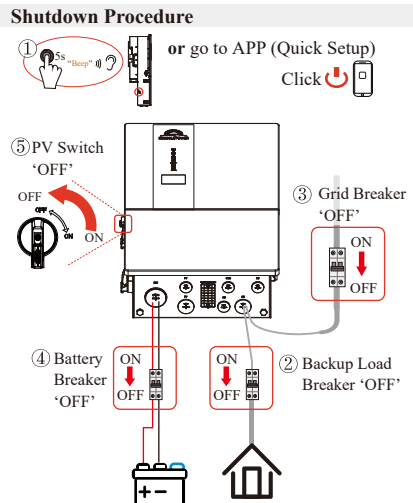

6 Commissioning

It is necessary to fully commission the inverter system for it is essential to protect the system from fire, electric shock, other damages, and personal injury.

6.1 Inspection

Before commissioning, the operator or installer (qualified personnel) must inspect the system carefully and ensure that:

- 1) The system is properly installed according to the contents and instructions in this manual, and there is sufficient space for operation, maintenance, and ventilation.
- 2) All terminals and cables are in good conditions.
- 3) No objects are left in/on the inverter or within the required clearance.
- 4) The PV and the battery pack are working normally, and the grid is normal.

6.2 Commissioning Procedure

When all items have been checked and the system is ready for use, start the commissioning procedure.

- 1) Power on the system by following the Startup Procedure in section 5.2.1.
- 2) Set the parameters on the App according to user's needs.
- 3) Complete commissioning.

7 User Interface

7.1 LED/LCD

7.1.1 LED Introduction

This section describes LED indicators, which include PV, BAT, GRID, BACKUP, COM, ALARM indicators.

The table below explains the status and description of all indicators. Please read it carefully.

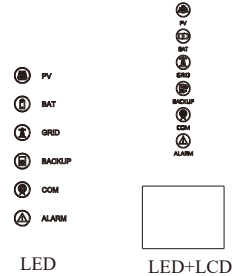

LED Indicator	Status	Description
PV	On	PV input is normal.
	Blink	PV input is abnormal.
	Off	PV is unavailable.
BAT	On	Battery is charging.
	Blink	Battery is discharging. Battery is abnormal.
	Off	Battery is unavailable.
GRID	On	GRID is available and normal.
	Blink	GRID is available and abnormal.
	Off	GRID is unavailable.
COM	Blink	Data are communicating.
	Off	No data transmission.
BACKUP	On	BACKUP power is available.
	Blink	BACKUP output is abnormal.
	Off	BACKUP power is unavailable.
ALARM	On	Fault has occurred and inverter shuts down.
	Blink	Alarms have occurred but inverter doesn't shut down.
	Off	No fault.

Details	Code	PV LED	Grid LED	BAT LED	BACKUP LED	COM LED	ALARM LED
PV normal		●	⊙	⊙	⊙	⊙	○
No PV		○	⊙	⊙	⊙	⊙	○
PV over voltage	B0						
PV under voltage	B4						
PV irradiation weak	B5	★	⊙	⊙	⊙	⊙	○
PV string reverse	B7						
PV string abnormal	B3						
On grid							
Bypass output		⊙	●	⊙	⊙	⊙	○
Grid absent	A2	⊙	○	⊙	⊙	⊙	○
Grid over voltage	A0						
Grid under voltage	A1						
Grid over frequency	A3						
Grid under frequency	A4	⊙	★	⊙	⊙	⊙	○
Grid abnormal	A6						
Grid over mean voltage	A7						
Neutral live wire reversed	A8						
Battery in charge		⊙	⊙	●	⊙	⊙	○
Battery unavailable		⊙	⊙	○	⊙	⊙	○
Battery absent	D1	⊙	⊙	○	⊙	⊙	○
Battery in discharge		⊙	⊙	★★	⊙	⊙	○
Battery under voltage	D3						
Battery over voltage	D2						
Battery discharge over current	D4	⊙	⊙	★	⊙	⊙	○
Battery over temperature	D5						
Battery under temperature	D6						
Communication loss (Inverter - BMS)	D8						
BACKUP output active		⊙	⊙	⊙	●	⊙	⊙
BACKUP output inactive		⊙	⊙	⊙	○	⊙	⊙
BACKUP short circuit	DB						
BACKUP over load	DC						
BACKUP output voltage abnormal	D7	⊙	⊙	⊙	★	⊙	○
BACKUP over dc-bias voltage	CP						

Details	Code	PV LED	Grid LED	BAT LED	BACKUP LED	COM LED	ALARM LED
RS485/DB9/BLE/USB		☉	☉	☉	☉	★	☉
Inverter over temperature	C5						
Fan abnormal	C8						
Inverter in power limit state	CL						
Data logger lost	CH	☉	☉	☉	☉	☉	★
Meter lost	CJ						
Remote off	CN						
PV insulation abnormal	B1						
Leakage current abnormal	B2						
Internal power supply abnormal	C0						
Inverter over dc-bias current	C2						
Inverter relay abnormal	C3						
GFCI abnormal	C6						
System type error	C7						
Unbalance Dc-link voltage	C9						
Dc-link over voltage	CA	☉	☉	☉	☉	☉	●
Internal communication error	CB						
Internal communication loss(E-M)	D9						
Internal communication loss(M-D)	DA						
Software incompatibility	CC						
Internal storage error	CD						
Data inconsistency	CE						
Inverter abnormal	CF						
Boost abnormal	CG						
Dc-dc abnormal	CU						

Remark: ● Light on ○ Light off ☉ Keep original status
 ★ Blink 1s and off 1s ★★ Blink 2s and off 2s

7.1.2 LCD Introduction

An LCD screen is optional for this series of inverters. If you choose the LCD screen, the following introduction will help you understand the function of each icon displayed.

Note:





The LCD screen will be automatically turned off if there is no operation within 10 mins (which cannot be changed by default). You can tap the ON/OFF button on the side of inverter to wake up the LCD screen.

Menu Structure Overview

<p>Actual LCD Screen</p>	<p>Function Overview</p>

Icon Introduction-1

	<p>This icon indicates WIFI connection status.</p>						
	<p>The date and time display information about year, month, day, and hour. The ':' between hour and minute flashes once a second.</p>						
	<p>The Warning icon only displays when an error occurs. For the specific warning code explanation, please refer to the chapter Inverter Troubleshooting.</p>						
	<p>These four icons show different operating statuses. Please refer to Chapter Inverter Working Mode for a detailed introduction.</p>						
	<p>This area shows the working conditions and energy flow directions. Please refer to Table Icon Status Description for a detailed introduction to each icon displayed.</p>						
	<p>The Energy Bars indicate the direction of energy flow. Each bar lights up one by one, then turns off when all bars light and repeats this cycle again.</p>						
	<p>The Energy Ring indicates the battery SOC or the current power percentage. Each Energy Ring definition is as follows.</p> <table border="0"> <tr> <td data-bbox="305 1310 546 1362"> <p>PV Input Power</p> </td> <td data-bbox="574 1310 988 1362"> <p>On-Grid Mode: Grid Output Power Non On-Grid Mode: Bypass load consumption power + Backup consumption power</p> </td> </tr> <tr> <td data-bbox="305 1382 546 1434"> <p>Battery SOC</p> </td> <td data-bbox="574 1382 988 1434"> <p>Backup</p> </td> </tr> <tr> <td data-bbox="305 1453 546 1506"> <p>Grid undervoltage</p> </td> <td data-bbox="574 1453 988 1506"> <p>Grid overvoltage</p> </td> </tr> </table>	<p>PV Input Power</p>	<p>On-Grid Mode: Grid Output Power Non On-Grid Mode: Bypass load consumption power + Backup consumption power</p>	<p>Battery SOC</p>	<p>Backup</p>	<p>Grid undervoltage</p>	<p>Grid overvoltage</p>
<p>PV Input Power</p>	<p>On-Grid Mode: Grid Output Power Non On-Grid Mode: Bypass load consumption power + Backup consumption power</p>						
<p>Battery SOC</p>	<p>Backup</p>						
<p>Grid undervoltage</p>	<p>Grid overvoltage</p>						

 <div style="display: flex; justify-content: space-around; border: 1px dashed gray; padding: 5px;"> <div style="text-align: center;">Icon Display Area</div> <div style="text-align: center;">Data Display Area</div> <div style="text-align: center;">Data Unit Display Area</div> </div>	<p>Example:</p> 
 <div style="display: flex; justify-content: space-around; border: 1px dashed gray; padding: 5px;"> <div style="text-align: center;">Icon Display Area</div> <div style="text-align: center;">Phase Display Area</div> <div style="text-align: center;">Data Display Area</div> <div style="text-align: center;">Data Unit Display Area</div> </div>	<p>Example:</p> 

Icon Introduction-2





















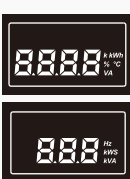





	<p>The PV icon represents the power of PV.</p>
	<p>The Battery icon represents the current battery charge percentage or the voltage of battery.</p>
	<p>The E-Today icon represents the electricity energy generated today.</p>
	<p>The E-Total icon represents the electricity energy generated in total.</p>
	<p>When the Loading icon is on, it indicates that the device is starting, and the start timer countdown is displayed. The icon lights up a cluster of lights every second until all lights are on, and then it repeats the whole process again.</p>
	<p>The Back-Up icon represents the relevant power, frequency or voltage of Back-Up.</p>
	<p>The Grid icon represents the relevant power, frequency or voltage of the Grid.</p>
	<p>The Smart Load icon represents the power consumption.</p>
	<p>The GEN icon represents the voltage or power of generator.</p>
	<p>The L1 icon represents L1 phase of Grid/Backup/Generator. The L2 icon represents L2 phase of Grid/Backup/Generator. The L3 icon represents L3 phase of Grid/Backup/Generator.</p>
	<p>These two areas will display corresponding data of each lit icon mentioned above.</p>

Table: Icon Status Description

Icon Status Description			
Icon	Name	Light	Description
	PV	ON	Any PV voltage exists (it should be higher than the Min. PV Startup Voltage) .
		OFF	PV Voltage is lower than the Min. PV Startup Voltage.
	Grid	ON	Grid Voltage and frequency are normal.
		OFF	Grid overvoltage / undervoltage / overfrequency / underfrequency occurs.
	Battery	ON	Bat. Voltage is higher than the Rated Min. Bat Voltage.
		OFF	Bat. Voltage is lower than the Rated Min. Bat Voltage.
	Back-Up Load	ON	Backup relay is on.
		OFF	Backup relay is off.
	BMS	ON	Battery is set to BMS Type and its communication is normal.
		Blink	BMS communication is abnormal.(The icon indicator on for one second, off for one second)
		OFF	1. Battery is not set to BMS Type. 2. Battery voltage is lower than Rated Min. Voltage
	BACKUP	ON/OFF	Lights up with Back-Up Load icon simultaneously
	Meter/CT	ON	Power Limit is set to CT or Meter in APP, and the CT/Meter communication is normal, the Grid side is running well.
		Blink	When Meter/CT communication is lost, Meter/CT icon on for one second, off for one second)
		OFF	1. Power Limit is not set to CT or Meter. 2. The voltage or frequency of grid side is abnormal.
	Load	ON/OFF	Lights up with Grid icon simultaneously.
	ON	ON	1. Backup relay is on. 2. The inverter works under On-Grid mode. 3. The inverter works under Off-Grid mode.
	OFF	OFF	Non-on working mode.
	Generator / Smart Load / Inverter	From left to right, when the three dots light up, each represents a different meaning.	
		When GEN communication is lost, GEN icon will go off.	
	GEN	ON	Generator relay is on.
		OFF	Generator replay is off.
	Generator dot	ON	In APP, the "Gen port" parameters are set to "Generator Input" and the generator relay is powered on.
		OFF	APP parameter is set to Non 'Generator Input'.
	Smart Load dot	ON	In APP, the "Gen port" parameters are set to "Smart Load Output" and the generator relay is powered on.
		OFF	APP parameter is set to Non 'Smart Load Output'.
	Inverter dot	ON	In APP, the "Gen port" parameters are set to "Inverter Input" and the generator relay is powered on.
		OFF	APP parameter is set to Non 'Inverter Input'.

7.2 App Setting Guide

7.2.1 Download App

- Scan the QR code on the inverter to download the APP.
- Download APP from the App Store or Google Play.

 Note:

The APP should access some permissions such as the device’s location. You need to grant all access rights in all pop-up windows when installing the APP or setting your phone.

7.2.2 App Architecture

It contains “Cloud Login” and “Local Login”.

- Cloud login: APP read data from cloud server through API and display inverter parameter
- Local login: APP read data from inverter through Bluetooth connection with Modbus protocol to display and configure inverter parameter.

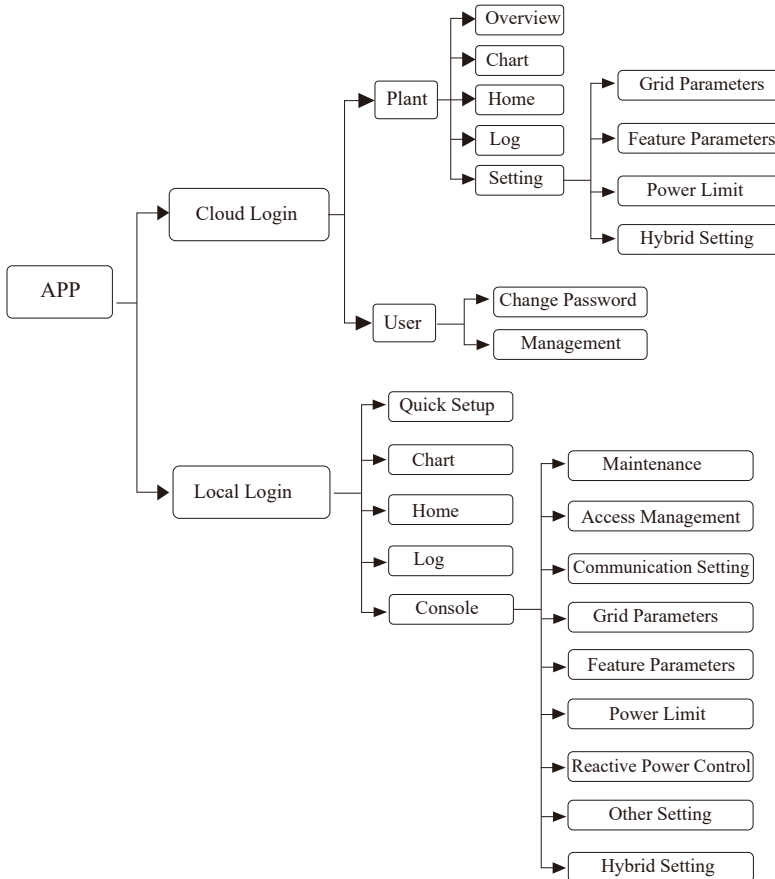

7.2.3 Local Login

■ Access Permission

Before using the local setting, the APP should access some permissions. (You can allow them when you install the APP or grant permissions in your own phone setting.) When the APP asks for permission, please click Allow.

■ Connect Inverter

Firstly, open the Bluetooth on your own phone, then open the APP.

Click Bluetooth Connection to enter scanning interface. This page will list the inverters which you can connect or you have connected. (As shown below) click the inverter’s name to connect it.

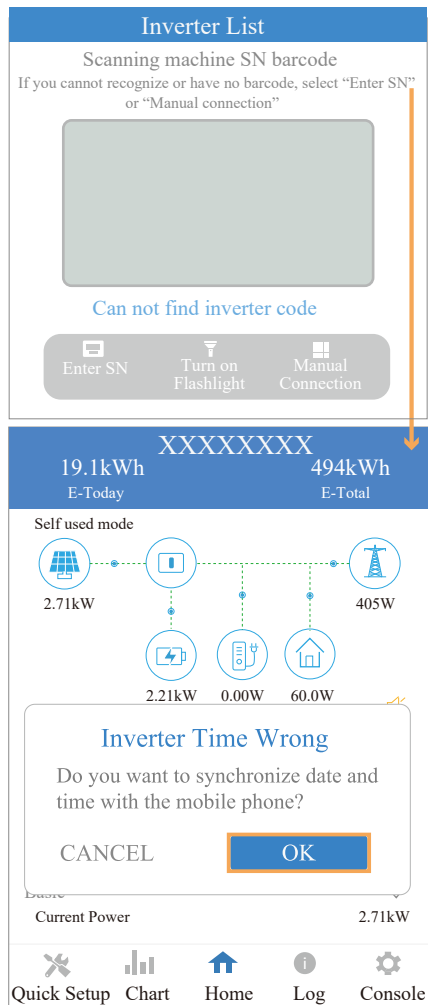
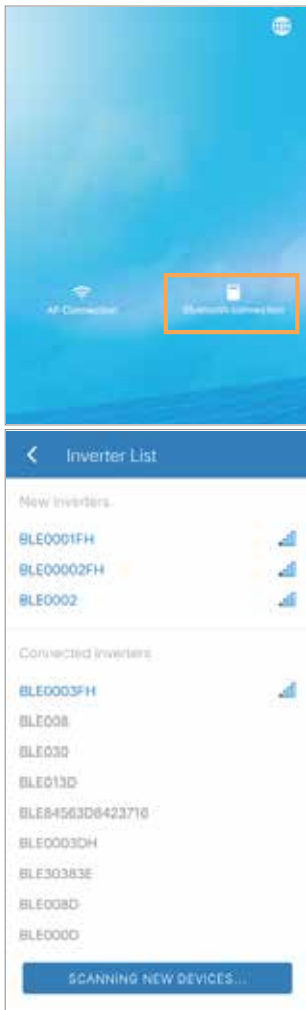

● **Quick Setting**

➤ Go to Quick Setup page.

Step 1 Set parameters for the inverter to connect to the power limit. Click each item to enter the information, then click **Next**.

Step 2 Set parameters for the inverter to connect to the workmode. Click each item to enter the information, then click **Next**. You can click **Previous** to go back to the previous page.

Step 3 Click the button below to turn on the inverter. You can click **Previous** to go back to the previous page.

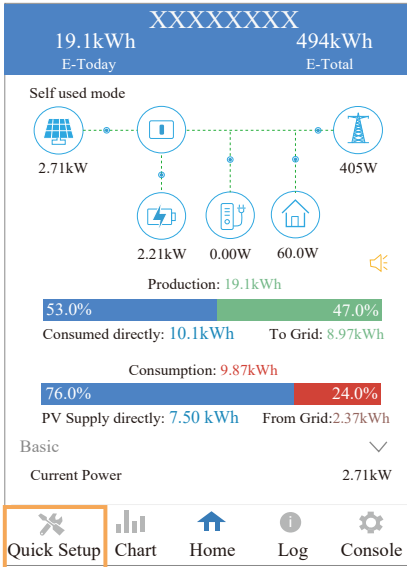

XXXXXXXXXX

1 2 3

Step1 Set parameters for the inverter to connect to the power limit.

Power control

Meter location

Meter Type

Power flow direction

Digital meter modbus address

Maximum feed in grid power(W)

Click each item to enter information.

Next

XXXXXXXXXX

1 2 3

Step2 Set parameters for the inverter to connect to the workmode.

Work mode

Battery Brand selection

Backup Output

Click each item to enter information.

Previous Next

XXXXXXXXXX

1 2 3

Step3 Please click the button below to turn on the inverter.

Power button

Previous

● **APP Power Chart**

The power chart is showed by Day, Month and Year in our APP. Data curves in the following figures are only for illustration.

➤ **Day Chart**

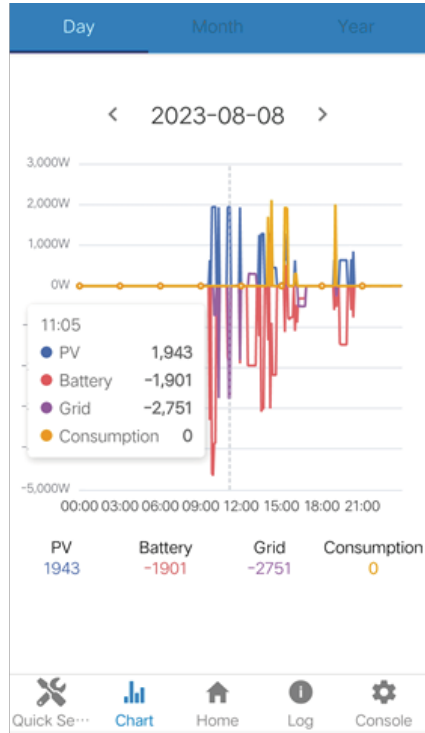
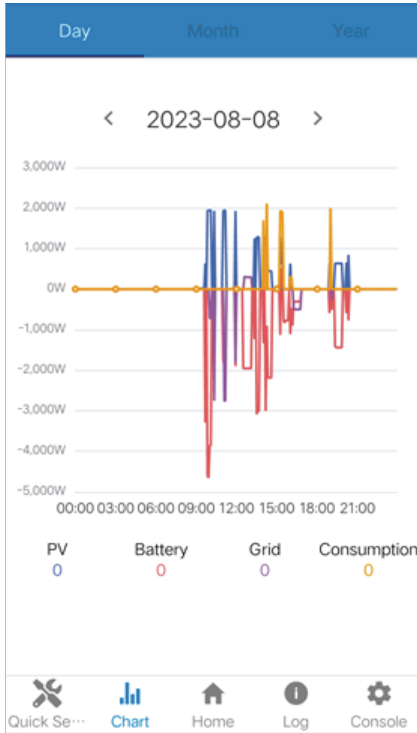

➤ **Month Chart**

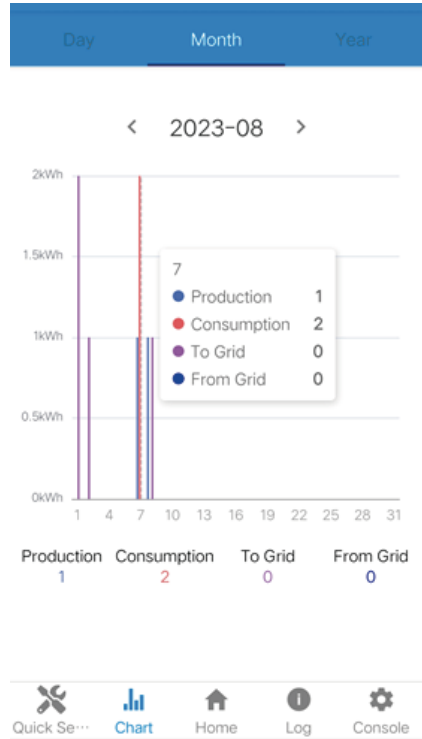
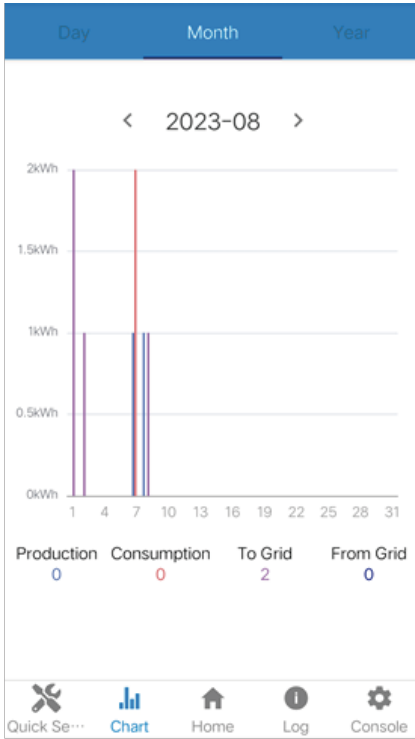

➤ Year Chart

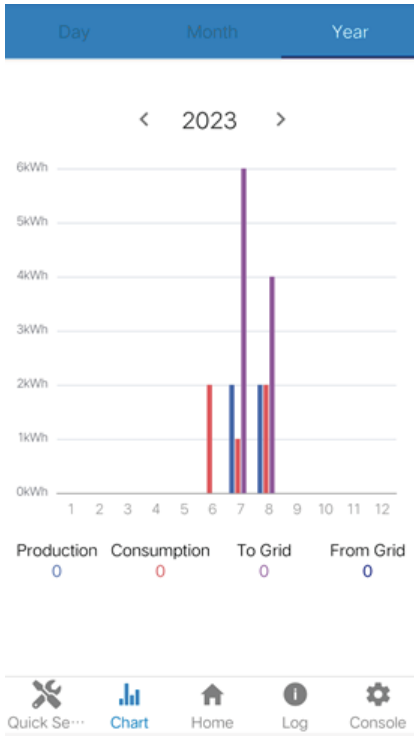

● **Local Setting Homepage**

This page shows the basic information of inverter. Click  to display the warning message.

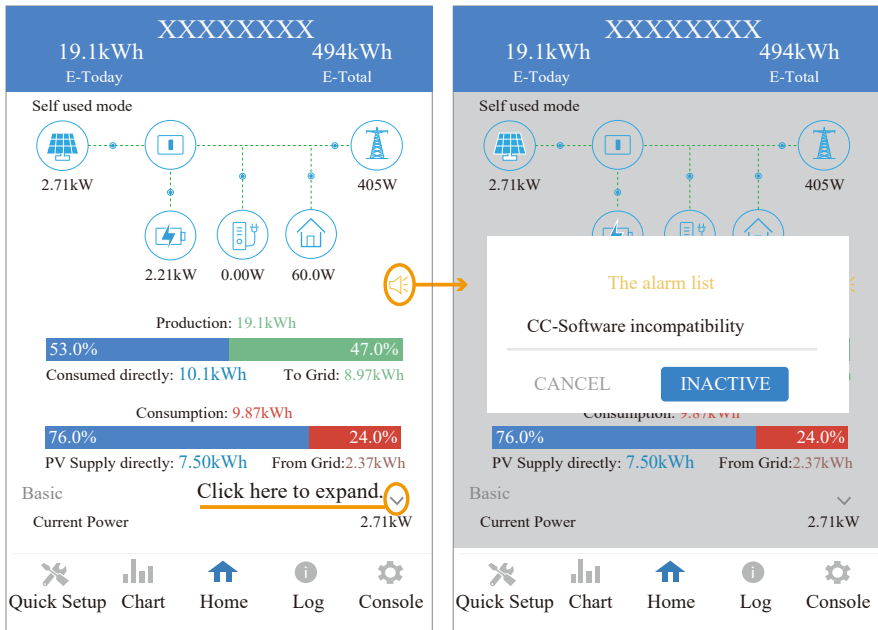

● **History Log**

Click Log at the bottom and then go to the history log page (as shown below). It contains all the logs for the inverter.

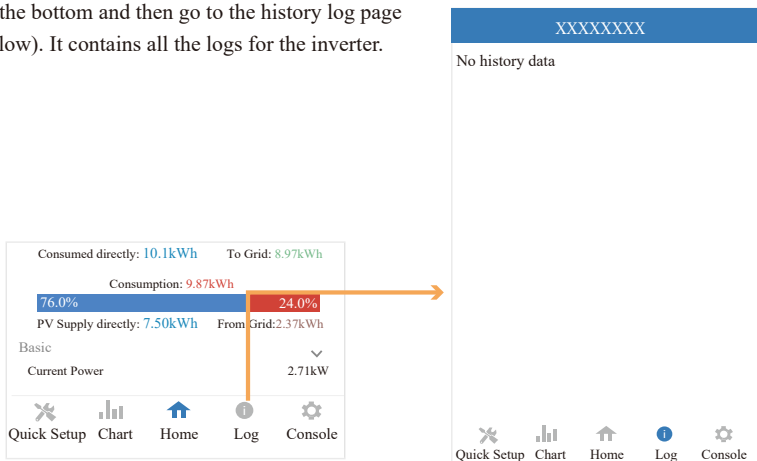

● Console

➤ Maintenance

Go to Console page and click Maintenance. In this page, you can view the basic information including version information, do some maintaining operations like turn off/on the inverter and manage data.

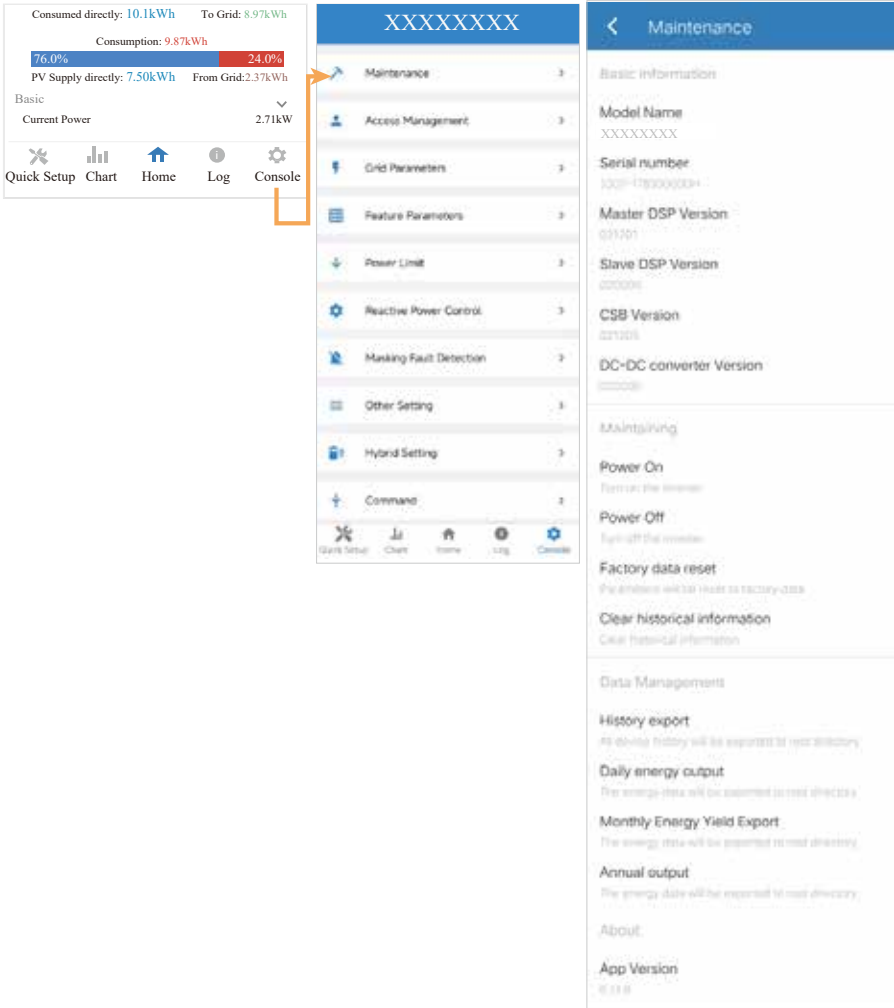

➤ **Access Management**

Go to Console > Access Management page. In this page, you can switch the login permission.

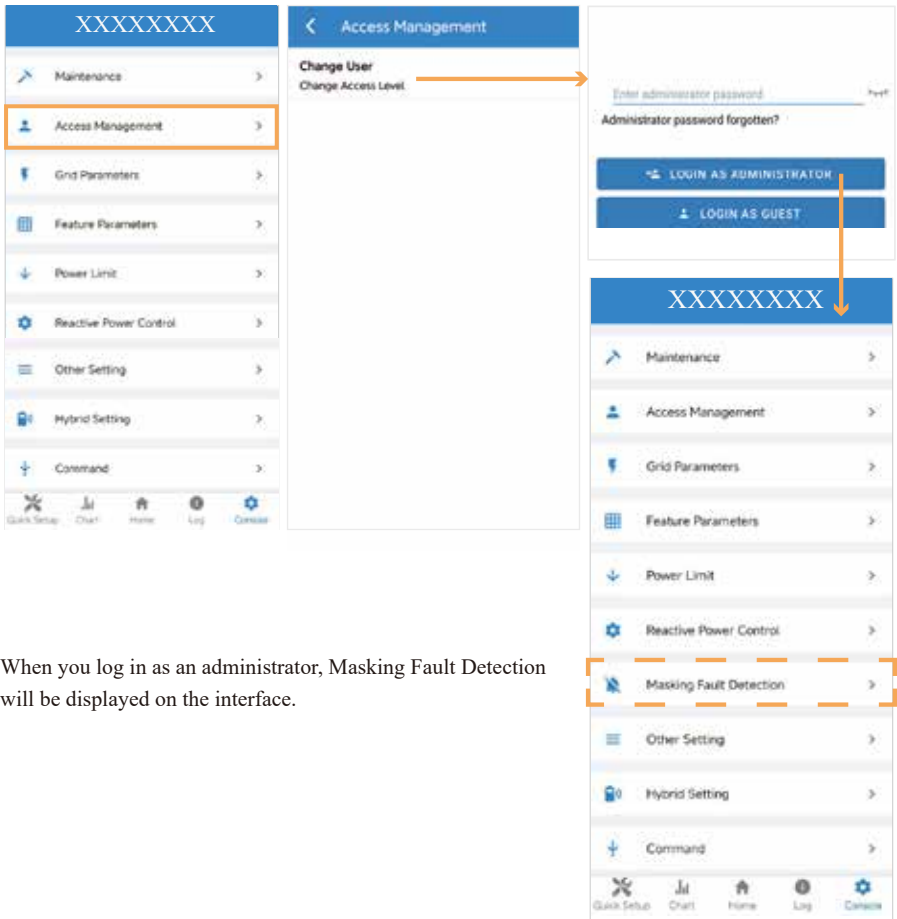

When you log in as an administrator, Masking Fault Detection will be displayed on the interface.

➤ Grid Parameters

Go to Console > Grid Parameters page. In this page, you can set or change the parameters of Grid side, as shown in the figure.

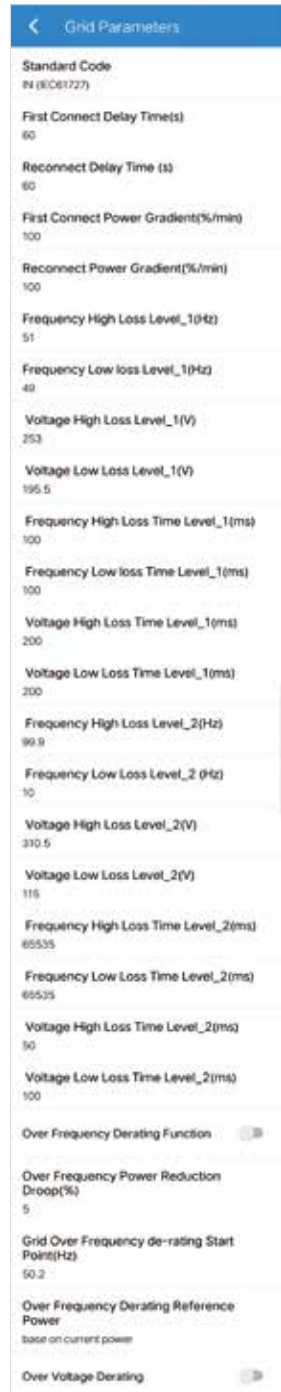
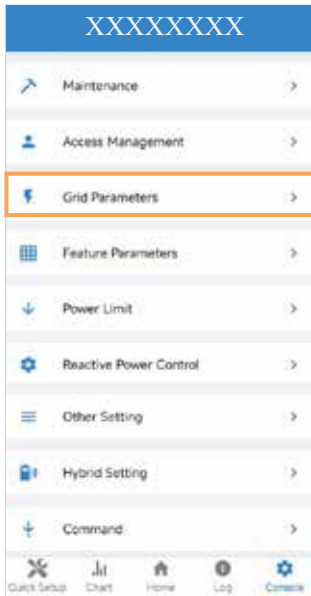

➤ **Feature Parameters**

Go to Console > Feature Parameters page. In this page, you can set or change the feature parameters, as shown in the figure.

➤ **Power Limit**

Go to Console > Power Limit page. In this page, you can set or change the parameters of power limit, as shown in the figure.

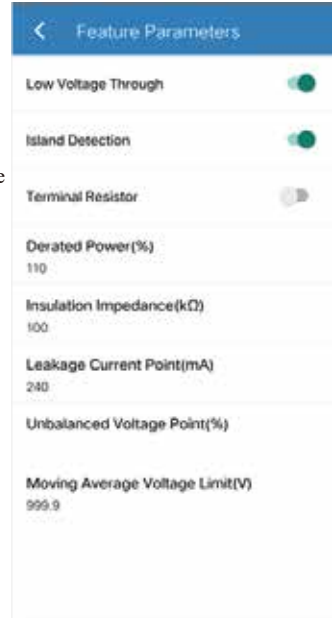
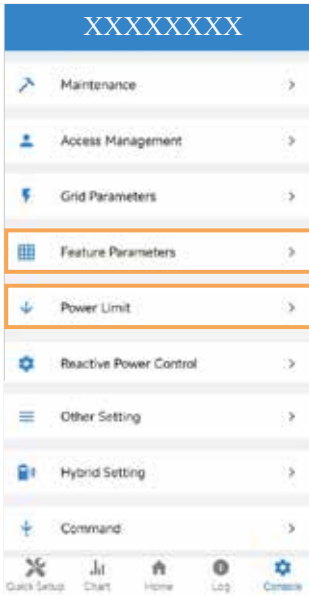

➤ **Reactive Power Control**

Go to Console > Reactive Power Control page. In this page, you can set or change the Reactive Power Control parameters.

➤ **Other Setting**

Go to Console > Other Setting page. In this page, you can set other setting parameters.

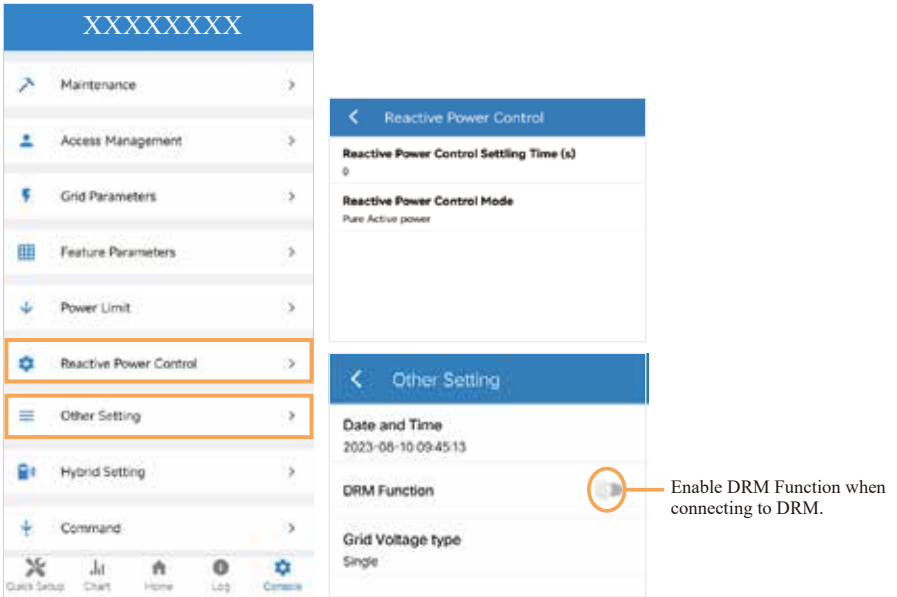

➤ **Hybrid Setting**

Go to Console > Hybrid Setting page. In this page, you can set contents about work mode, battery, backup Load, generator and other. The setting interfaces are listed one by one.

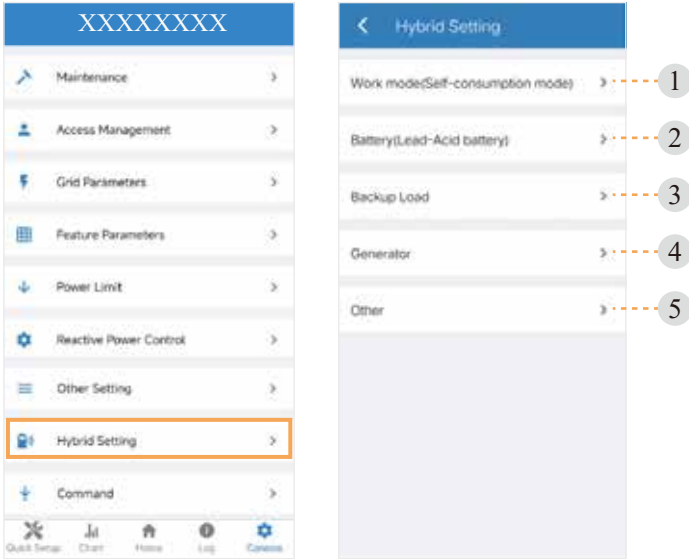

1 **Work mode**

In Work mode page, there are four work modes are available.

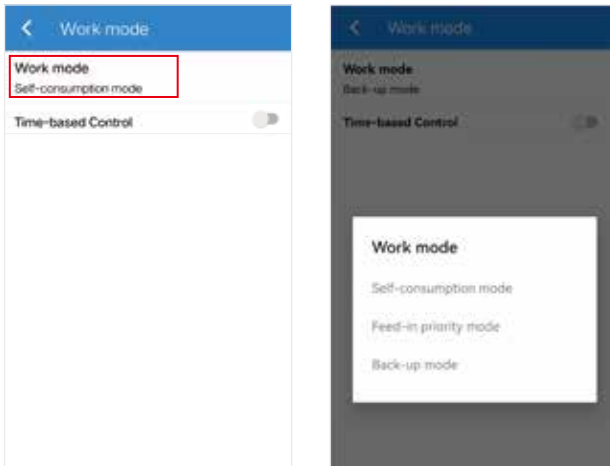

In Work mode page, you can also find “Time-based Control” function. This function is designed to control the time setting of charging and discharging the inverter. You can set the following parameters based on your requirements:

- Charge and discharge frequency: one time or daily
- Charging start time: 0 to 24 hours
- Charging end time: 0 to 24 hours
- Discharge start time: 0 to 24 hours
- Discharge end time: 0 to 24 hours

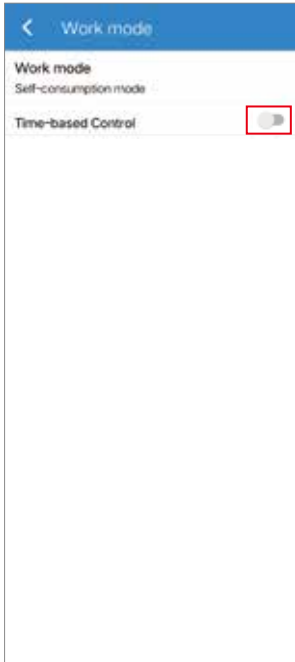

2 Battery

In [Battery](#) page, information including battery parameters, charging and discharging management and grid will be listed. Enter corresponding information if necessary.

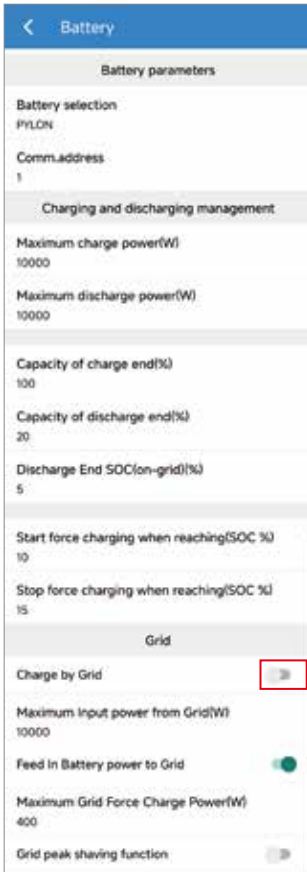

Choose whether to allow the grid to charge the battery, which is prohibited by default. When the battery capacity or voltage reaches the set value, the grid will stop charging the battery.

3 Backup Load

In Backup Load page, if enabling Backup Output, you can set parameters including the range of backup output voltage and Min. initiation/startup battery capacity when off-grid.



4 Generator

To activate functions about generator of the inverter, you should first standby the inverter to connect the App, then set parameters below to enable the functions that you need, and finally power on the inverter to start.

➤ Generator Input Mode

- **Generator Input Mode:** In this mode, while the generator is off the grid, the GEN port functions as an input port from the generator. The backup load or battery charging can be supplied by the generator input. The generator can be started and stopped in two ways: via the inverter's dry contact and manually. For the former, the inverter has total control over the generator's start and stop operations. In the latter case, you can apply manual control to start and stop the generator.



Note:

The nominal power of generator should be 1.3 times larger than that of the hybrid inverter.

- Go to Hybrid Setting > Generator > Generator Port page and choose Generator Input as below.

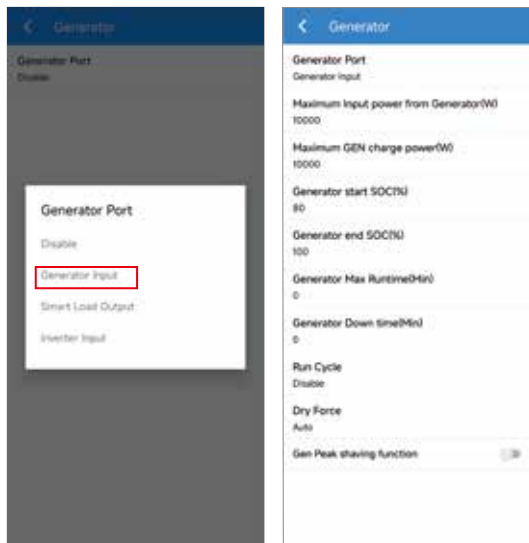

- All parameters have been set by default.

Maximum Input power from Generator (W)

Forbid the generator power larger than the setting value (W).

Maximum GEN charger power (W)

Maximum battery charge power from generator.

Generator start SOC (%)

Battery SOC below which the generator starts to charge the battery. Meanwhile, the generator’s running time should not exceed the maximum runtime setting value (Min).

Generator Max Runtime (Min)

When the generator’s running time reaches to the setting value, the inverter will disconnect the input from generator. But the generator will keep working for a while defined by “Generator down time(Min)”.

Generator end SOC (%)

Battery SOC above which the generator stops charging the battery.

Generator Down time (Min)

When the inverter disconnects the input from generator, the generator will keep working for a while by the down time setting value (Min).

- For generator that switch on and off by dry contact, it will stop working automatically when the generator working time reaches to the down time setting value (Min).
- For generator that are manually switched on and off, it will stop working by manual regardless of the down time setting value (Min).

Run Cycle

Generator Cycle run mode. You can set as Weekly or Month cycle.

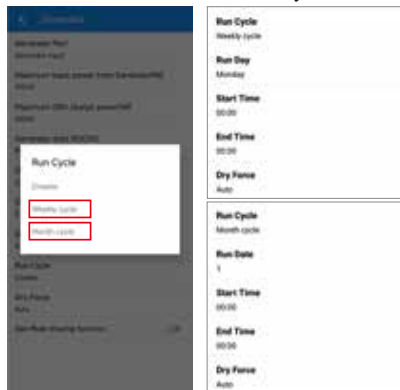

Dry force

When the Grid power is abnormal, the generator is forced to be turned on.

Generator start Bat. Volt(V)

Battery voltage below which the generator starts to charge the battery.

Meanwhile, the generator running time should not exceed the maximum runtime setting value (Min).

Generator end Bat. Volt(V)

Battery voltage above which the generator stops charging the battery.

The default values of **Generator Input** are as below:

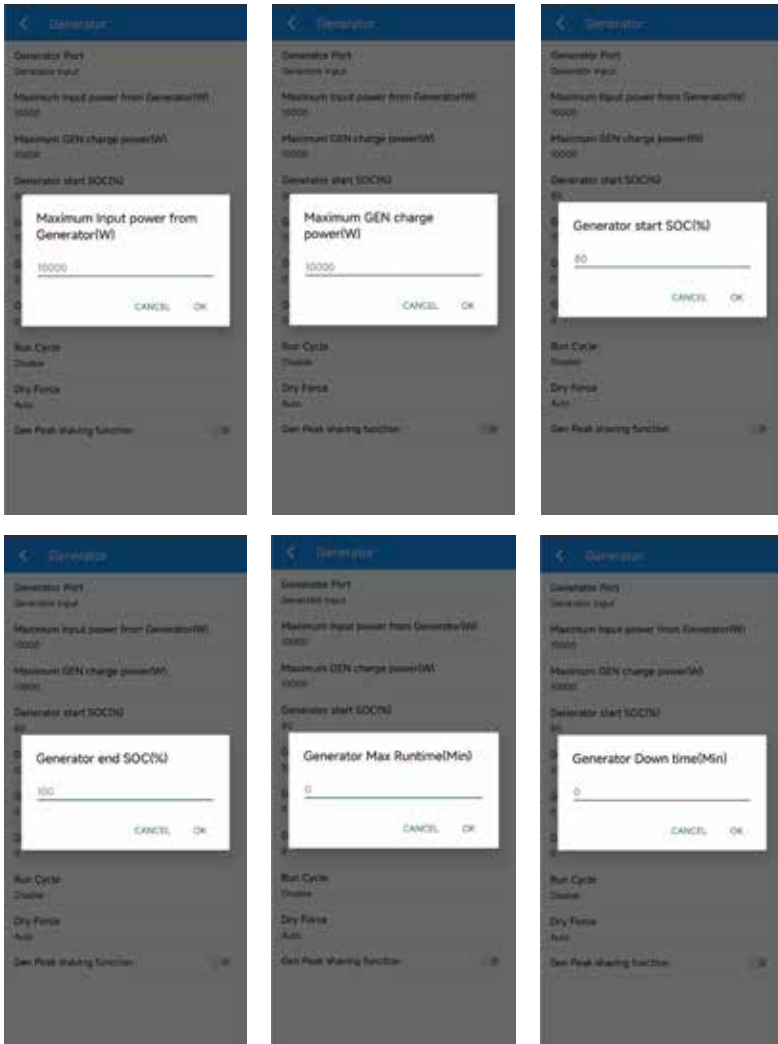

Note:

1. If 'Generator Max Runtime (Min)' sets to 0, it means the generator can run all the time.
2. The default value of **Generator start Bat. Volt(V)** is 48 V.
3. The default value of **Generator end Bat. Volt(V)** is 64 V.

- If the values are set as described above, and Capacity Mode is set to SOC (%), the situations are as follows:
 - In off-grid mode, the Generator Input function being ON or OFF depends on the set values of the battery SOC and the Generator Max Runtime.
 - When the value of battery SOC is lower than 80% and the runtime is less than the set value of Generator Max Runtime (Min), the GEN Port function will be enabled and the Generator Input will be turned on.
 - When the battery SOC is $\geq 100\%$ or the run time is longer than the set Generator Max Runtime (Min), the GEN port function will be disabled and the Generator Input will be turned to OFF.
 - In on-grid mode, the GEN Port function will be disabled and the Generator Input will be turned off.

 Note:

1. The total generator running time is equal to “Generator Max Runtime (Min)” plus “Generator down time (Min)”.
2. Go to Hybrid setting > Other > Capacity Mode, you can switch Capacity Mode to voltage (V), as shown in below figure, so that parameter settings about **Generator start SOC (%)** will be changed to **Generator start Bat. Volt (V)**. Also, parameter settings about **Generator end SOC (%)** will be changed to **Generator start Bat. Volt (V)**. Yet, under this mode the Generator Input function still follows the running logic you set above.

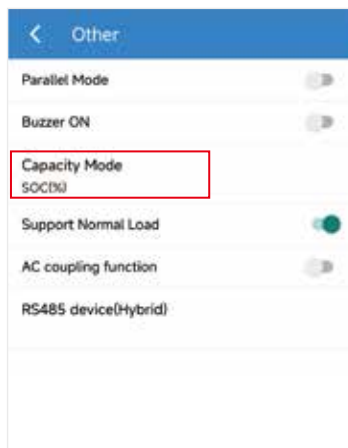

3. If the generator and the grid run normally, the load and battery charging will be powered by the grid in priority.

➤ Smart Load Output Mode Introduction

- **Smart Load Output Mode:** In this mode, the GEN Port works as an output port for the Smart Load connected to the GEN terminal.
- Go to Hybrid Setting > Generator > Generator Port page and choose Smart Load Output as below.

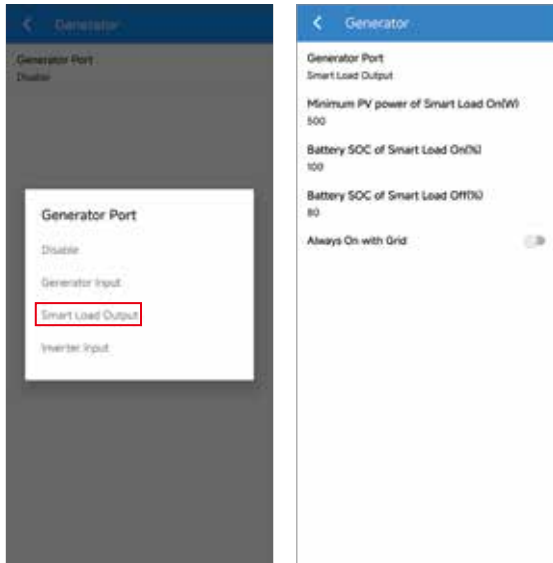

- All parameters have been set by default.

Minimum PV power of Smart Load On (W) & Battery SOC of Smart Load On (%)

If the PV input power is higher than the setting value(Power), and the battery SOC exceeds the setting value simultaneously, the Smart Load will be switched on.

Battery SOC of Smart Load Off (%)

If the battery SOC is lower than the setting value, the Smart Load will be switched off.

Always On with Grid

When the grid is present, click “Always On with Grid”, and the Smart Load will be switched on.

Battery voltage of Smart Load On (V)

If the battery voltage is higher than the setting value, and the PV input power exceeds the setting power simultaneously, the Smart Load will be switched on.

Battery voltage of Smart Load Off (V)

If the battery voltage is lower than the setting value, the Smart Load will switch off.

The default values of Smart Load Output are as below:

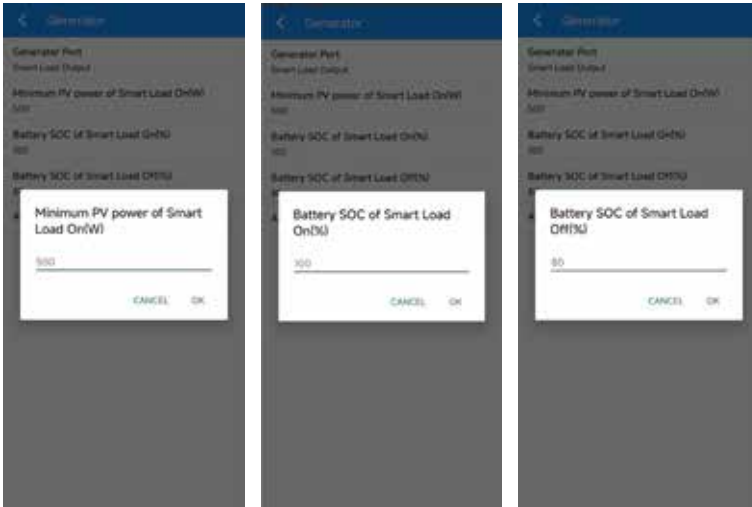

Note:

1. Go to Hybrid setting > other > Capacity Mode, when you set Capacity Mode to Voltage (V), parameter settings about **Battery SOC of Smart Load On (%)** will be changed to **Battery voltage of Smart Load On (V)**. Also, parameter settings about **Battery SOC of Smart Load Off (%)** will be changed to **Battery voltage of Smart Load Off (V)**. Yet, under this mode the Smart Load Output function still follows the running logic you set.

2. The default value of **Battery Voltage of Smart Load On(V)** is 60 V;
3. The default value of **Battery Voltage of Smart Load Off(V)** is 40 V.

▪ If the values are set as described above, and Capacity Mode is set to SOC (%), the situations are as follows:

- When Always On with Grid is turned to ON:

If the grid is present, the Smart Load Output will be on all the time without effect from the change of parameters mentioned above. If the grid is absent, the Smart Load Output being ON or OFF depends on the PV power and the battery SOC.

If the PV power is ≥ 500 W and the battery SOC $\geq 100\%$, the Smart Load Output will be on. If the battery SOC is $< 80\%$, the Smart Load Output will be off. If the PV power is < 500 W or the battery SOC $< 80\%$, the Smart Load Output will be off.

- When Always On with Grid is turned to OFF:

If the PV power is ≥ 500 W and the battery SOC $\geq 100\%$, the GEN Port function will be enabled and the Smart Load Output will be ON. In the state of Smart Load ON, if the battery SOC is $< 80\%$, the Smart Load will be OFF.

If the PV power is < 500 W or the battery SOC $< 80\%$, the GEN Port function will be disabled and the Smart Load will be OFF.

➤ **Inverter Input Mode Introduction**

- **Inverter Input Mode:** Under this mode, the GEN Port works as an input port from other grid-tied inverter whose rated power should be less than the hybrid inverter. The grid-tied inverter should also support derating output power according to the output frequency.



Note:

The capacity of grid-tied inverter should be less than that of hybrid inverter.

- Go to Hybrid Setting > Generator > Generator Port page and choose Inverter Input.

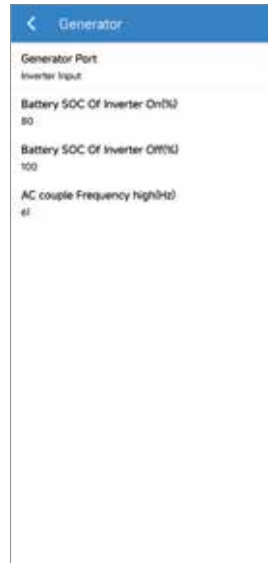
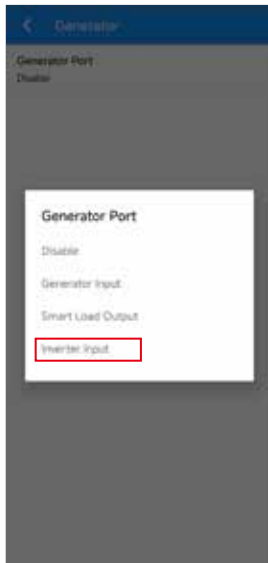

- All parameters have been set by default.

Battery SOC of Inverter On (%)

If the battery SOC is lower than the default value, the inverter powers on and starts to charge the battery.

Battery SOC of Inverter Off (%)

If the battery SOC is higher than the default value, the inverter powers off and stops charging the battery.

AC couple Frequency high (Hz)

This parameter is used to limit the output power of grid-tied inverter when the hybrid inverter works under off-grid mode. As the battery SOC gradually reaches to the setting value (Off), during the process, the grid-tied inverter output power will decrease linear. When the battery SOC equal to the setting value (Off), the system frequency will become the setting value (AC Couple Frequency high) and the grid-tied inverter will stop working.

Battery Voltage of Inverter On (V)

If battery voltage lower than the setting value, the inverter powers on and starts charging the battery.

Battery Voltage of Inverter Off (V)

If battery voltage higher than the setting value, the inverter powers off and stops charging the battery.

 Note:

Go to Hybrid setting > Other > Capacity Mode, when you set Capacity Mode to voltage (V), parameter settings about **Battery SOC of Inverter On (%)** will be changed to **Battery voltage of Inverter On (V)**. Also, parameter settings about **Battery SOC of Inverter Off (%)** will be changed to **Battery voltage of Inverter Off (V)**. Yet, under this mode the Inverter Input function still follows the running logic you set.

The default values of **Inverter Input** are as below:

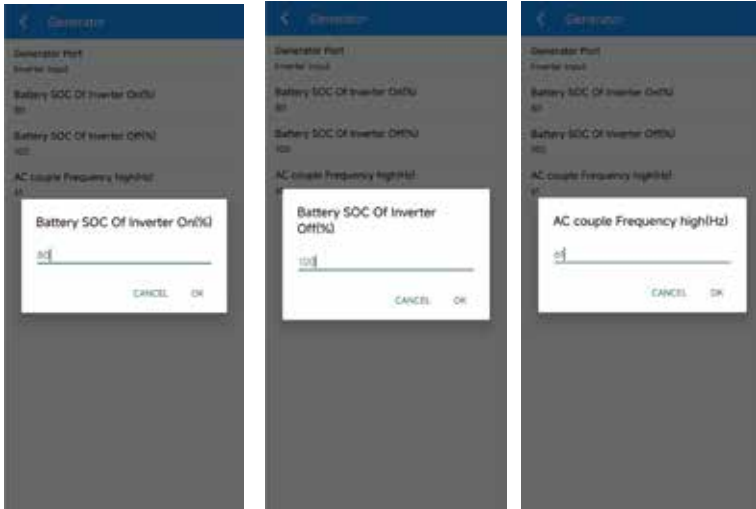

 Note:

The default value of **Battery Voltage of Inverter On(V)** is 40 V;

The default value of **Battery Voltage of Inverter Off(V)** is 64 V.

- If the values are set as described above, and Capacity Mode is set to SOC (%), the situations are as follows:
 - In off-grid mode, the Inverter Input being on or off depends on the battery SOC.
 - When the Battery SOC $\leq 80\%$, the GEN port function will be enabled and Inverter Input will be ON.
 - When the battery charge power lower than the grid-tied inverter output power, the hybrid inverter will increase the output frequency to maximum 61 Hz. Then the grid-tied inverter will work in limited power mode.
 - When the Battery SOC $\geq 100\%$, the GEN port function will be disabled and Inverter Input will be OFF.
 - Under on-grid mode, the grid-tied inverter works as normal regardless of battery capacity.

Logic Diagram of Enable/Disable GEN Port Function

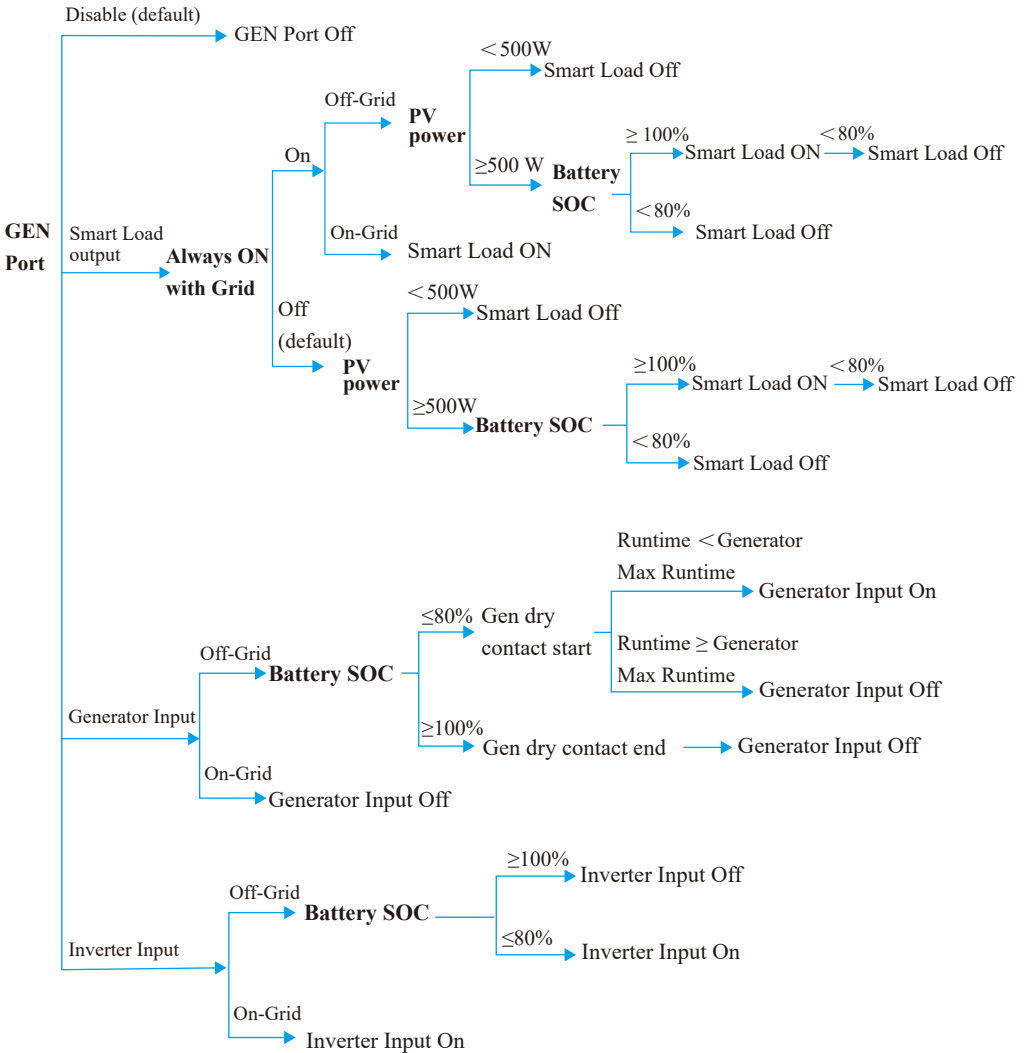

Note:

When the Capacity Mode was set to voltage, the Gen Port still follows the above logic.

5 Other

In **Other** page, options including Parallel mode, Buzzer ON, Support Normal Load are listed. Enable them when necessary.

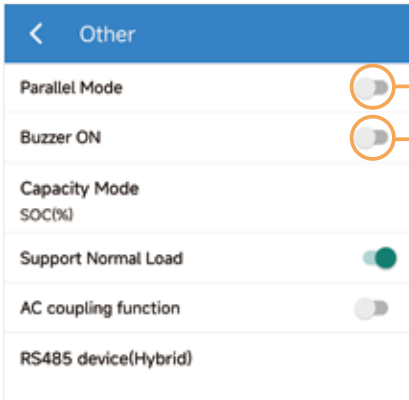

Enable Parallel Mode when applying parallel connection mode.
Enable Buzzer On to open the Buzzer function.

► Parallel mode

In **Other** page, if enabling Parallel Mode, you can set the following parameters:

- Parallel System Battery Connect Type
- Set phase position (for more details, please refer to Chapter 4.)

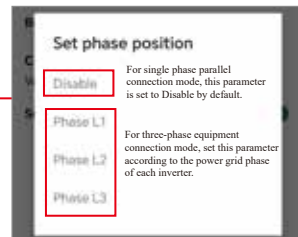
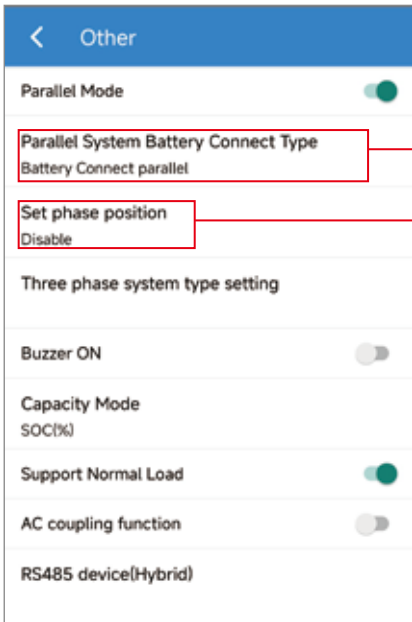

8 Maintenance



CAUTION

Before maintaining and commissioning inverter and its peripheral distribution unit, switch off all the charged terminals of the inverter and wait at least 10 minutes after the inverter is powered off.

8.1 Routine Maintenance

Items	Check Content	Maintain Content	Maintenance Interval
Inverter output status	Statistically maintain the status of electrical yield, and remotely monitor its abnormal status.	N/A	Weekly
Inverter cleaning	Check periodically that the heat sink is free from dust and blockage.	Clean periodically the heat sink.	Yearly
Inverter running status	Check that the inverter is not damaged or deformed. Check for normal sound emitted during inverter operation. Check and ensure that all inverter communications are running well.	If there is any abnormal phenomenon, replace the relevant parts.	Monthly
Inverter electrical connections	Check that all AC, DC and communication cables are securely connected; Check that PGND cables are securely connected; Check that all cables are intact and free from aging.	If there is any abnormal phenomenon, replace the cable or re-connect it.	Semiannually

8.2 Inverter Troubleshooting

When the inverter has an exception, its basic common warning and handling methods are shown below.

Code	Alarm Information	Suggestions
A0	Grid over voltage	<ol style="list-style-type: none"> 1. If the alarm occurs occasionally, possibly the power grid voltage is abnormal temporarily, and no action is required. 2. If the alarm occurs repeatedly, contact the local power station. After receiving approval of the local power bureau, revise the electrical protection parameter settings on the inverter through the App. 3. If the alarm persists for a long time, check whether the AC circuit breaker /AC terminals is disconnected, or if the grid has a power outage.
A1	Grid under voltage	
A3	Grid over frequency	
A4	Grid under frequency	
A2	Grid absent	Wait till power is restored.
B0	PV over voltage	Check whether the maximum input voltage of a single PV string exceeds the MPPT working voltage. If yes, modify the number of PV module connection strings.
B1	PV insulation abnormal	<ol style="list-style-type: none"> 1. Check the insulation resistance against the ground for the PV strings. If a short circuit has occurred, rectify the fault. 2. If the insulation resistance against the ground is less than the default value in a rainy environment, set insulation resistance protection on the App.
B2	Leakage current abnormal	<ol style="list-style-type: none"> 1. If the alarm occurs occasionally, the inverter can be automatically recovered to the normal operating status after the fault is rectified. 2. If the alarm occurs repeatedly, contact your dealer for technical support.
B4	PV under voltage	<ol style="list-style-type: none"> 1. If the alarm occurs occasionally, possibly the external circuits are abnormal accidentally. The inverter automatically recovers to the normal operating status after the fault is rectified. 2. If the alarm occurs repeatedly or last a long time, check whether the insulation resistance against the ground of PV strings is too low.
C0	Internal power supply abnormal	<ol style="list-style-type: none"> 1. If the alarm occurs occasionally, the inverter can be automatically restored, and no action is required. 2. If the alarm occurs repeatedly, please contact the customer service.

C2	Inverter over dc-bias current	<ol style="list-style-type: none"> 1. If the alarm occurs occasionally, possibly the power grid voltage is abnormal temporarily, and no action is required. 2. If the alarm occurs repeatedly, and the inverter fails to generate power, contact the customer service.
C3	Inverter relay abnormal	<ol style="list-style-type: none"> 1. If the alarm occurs occasionally, possibly the power grid voltage is abnormal temporarily, and no action is required. 2. If the alarm occurs repeatedly, pls. refer to the suggestions or measures of Grid over voltage. If the inverter fails to generate power, contact the customer service center. If there is no abnormality on the grid side, the machine fault can be determined. (If you open the cover and find traces of damage to the relay, it can be concluded that the machine is faulty.) And pls. contact the customer service.
CN	Remote off	<ol style="list-style-type: none"> 1. Local manual shutdown is performed in APP. 2. The monitor executed the remote shutdown instruction. 3. Remove the communication module and confirm whether the alarm disappears. If yes, replace the communication module. Otherwise, please contact the customer service.
C5	Inverter over temperature	<ol style="list-style-type: none"> 1. If the alarm occurs occasionally, the inverter can be automatically recovered. No action is required. 2. If the alarm occurs repeatedly, please check whether the installation site has direct sunlight, bad ventilation, or high ambient temperature (such as installed on the parapet). Yet, if the ambient temperature is lower than 45° C and the heat dissipation and ventilation is good, please contact customer service.
C6	GFCI abnormal	<ol style="list-style-type: none"> 1. If the alarm occurs occasionally, it could have been an occasional exception to the external wiring. The inverter can be automatically recovered. No action is required. 2. If it occurs repeatedly or cannot be recovered for a long time, please contact customer service.
B7	PV string reverse	Check and modify the positive and negative polarity of the input string.
C8	Fan abnormal	<ol style="list-style-type: none"> 1. If the alarm occurs occasionally, please restart the inverter. 2. If it occurs repeatedly or cannot be recovered for a long time, check whether the external fan is blocked by other objects. Otherwise, Please contact customer service.
C9	Unbalance Dc-link voltage	<ol style="list-style-type: none"> 1. If the alarm occurs occasionally, the inverter can be automatically recovered. No action is required. 2. If the alarm occurs repeatedly, the inverter cannot work properly. Please contact customer service.
CA	Dc-link over voltage	

CB	Internal communication error	<ol style="list-style-type: none"> 1. If the alarm occurs occasionally, the inverter can be automatically recovered and no action is required. 2. If the alarm occurs repeatedly, the inverter cannot work properly. Pls. contact the customer service center.
CC	Software incompatibility	<ol style="list-style-type: none"> 1. If the alarm occurs occasionally, the inverter can be automatically recovered and no action is required. 2. If the alarm occurs repeatedly, the inverter cannot work properly. Pls. contact the customer service center.
CD	Internal storage error	<ol style="list-style-type: none"> 1. If the alarm occurs occasionally, the inverter can be automatically recovered and no action is required. 2. If the alarm occurs repeatedly, the inverter cannot work properly. Pls. contact the customer service center.
CE	Data inconsistency	<ol style="list-style-type: none"> 1. If the alarm occurs occasionally, the inverter can be automatically recovered and no action is required. 2. If the alarm occurs repeatedly, the inverter cannot work properly. Pls. contact the customer service center.
CF	Inverter abnormal	<ol style="list-style-type: none"> 1. If the alarm occurs occasionally, the inverter can be automatically recovered and no action is required. 2. If the alarm occurs repeatedly, the inverter cannot work properly. Pls. contact the customer service center.
CG	Boost abnormal	<ol style="list-style-type: none"> 1. If the alarm occurs occasionally, the inverter can be automatically recovered and no action is required. 2. If the alarm occurs repeatedly, the inverter cannot work properly. Pls. contact the customer service center.
CJ	Meter lost	<ol style="list-style-type: none"> 1. Check the meter parameter Settings 2. Local APP checks that the communication address of the inverter is consistent with that of the electricity meter 3. The communication line is connected incorrectly or in bad contact 4. electricity meter failure. 5. Exclude the above, if the alarm continues to occur, please contact the customer service center.
P1	Parallel ID warning	It is Parallel ID Alarm. Pls. check the parallel communication cable, and check whether any inverter joins or exits online. All inverters are powered off completely, check the line, and then power on the inverters again to ensure that the alarm is cleared.
P2	Parallel SYN signal warning	Parallel synchronization signal is abnormal. Check whether the parallel communication cable is properly connected.
P3	Parallel BAT abnormal	The parallel battery is abnormal. Whether the battery of the inverter is reported low voltage or the battery is not connected.
P4	Parallel GRID abnormal	The parallel grid is abnormal. Whether the grid of the inverter is abnormal.

P5	Phase Sequence abnormal	<p>Ensure that Set phase position on APP is consistent with the power grid phase. There are two ways to clear this alarm:</p> <ol style="list-style-type: none"> 1. Power off each inverter, change the phase sequence for each inverter and then power on inverter. 2. Standby each inverter, change the phase sequence for each inverter on APP, power off inverter, and then power on inverter. <p>If exclude the above, the alarm continues to occur, please contact the customer service center.</p>
D2	Battery over voltage	<ol style="list-style-type: none"> 1. If the alarm occurs occasionally, the inverter can be automatically recovered and no action is required. 2. Check that the battery overvoltage protection value is improperly set. 3. The battery is abnormal. 4. If exclude the above, the alarm continues to occur, please contact the customer service center.
D3	Battery under voltage	<ol style="list-style-type: none"> 1. If the alarm occurs occasionally, the inverter can be automatically recovered and no action is required. 2. Check the communication line connection between BMS and inverter (lithium battery). 3. The battery is empty or the battery voltage is lower than the SOC cut-off voltage. 4. The battery undervoltage protection value is improperly set. 5. The battery is abnormal. 6. If exclude the above, the alarm continues to occur, please contact the customer service center.
D4	Battery discharger over current	<ol style="list-style-type: none"> 1. Check whether the battery parameters are correctly set. 2. Battery undervoltage. 3. Check whether a separate battery is loaded and the discharge current exceeds the battery specifications. 4. The battery is abnormal. 5. If exclude the above, the alarm continues to occur, please contact the customer service center.
D5	Battery over temperature	<ol style="list-style-type: none"> 1. If the alarm occurs repeatedly, please check whether the installation site is in direct sunlight and whether the ambient temperature is too high (such as in a closed room).
D6	Battery under temperature	<ol style="list-style-type: none"> 2. If the battery is abnormal, replace it with a new one. 3. If exclude the above, the alarm continues to occur, please contact the customer service center.
D7	BACKUP output voltage abnormal	<ol style="list-style-type: none"> 1. Check whether the BACKUP voltage and frequency Settings are within the specified range. 2. Check whether the BACKUP port is overloaded. 3. When not connected to the power grid, check whether BACKUP output is normal. 4. If exclude the above, the alarm continues to occur, please contact the customer service center.

D8	Communication error (Inverter-BMS)	<ol style="list-style-type: none"> 1. Check whether the battery is disconnected. 2. Check whether the battery is well connected with the inverter. 3. Confirm that the battery is compatible with the inverter. It is recommended to use CAN communication. 4. Check whether the communication cable or port between the battery and the inverter is faulty. 5. If exclude the above, the alarm continues to occur, please contact the customer service center.
D9	Internal communication loss(E-M)	<ol style="list-style-type: none"> 1. Check whether the communication cables between BACKUP, electricity meter and inverter are well connected and whether the wiring is correct 2. Check whether the communication distance is within the specification range
DA	Internal communication loss(M-D)	<ol style="list-style-type: none"> 3. Disconnect the external communication and restart the electricity meter and inverter. 4. If exclude the above, the alarm continues to occur, please contact the customer service center.
CU	Dcdc abnormal	<ol style="list-style-type: none"> 1. If the alarm occurs occasionally, the inverter can be automatically recovered and no action is required. 2. If the alarm occurs repeatedly, please check: <ol style="list-style-type: none"> 1) Check whether the MC4 terminal on the PV side is securely connected. 2) Check whether the voltage at the PV side is open circuit, ground to ground, etc. <p>If exclude the above, the alarm continues to occur, please contact the customer service center.</p>
CP	BACKUP over dc-bias voltage	<ol style="list-style-type: none"> 1. If the alarm occurs occasionally, the inverter can be automatically recovered and no action is required. 2. If the alarm occurs repeatedly, the inverter cannot work properly. Pls. contact the customer service center.
DB	BACKUP short circuit	<ol style="list-style-type: none"> 1. Check whether the live line and null line of BACKUP output are short-circuited. 2. If it is confirmed that the output is not short-circuited or an alarm, please contact customer service to report for repair. (After the troubleshooting of alarm problems, BACKUP switch needs to be manually turned on during normal use.)
DC	BACKUP over load	<ol style="list-style-type: none"> 1. Disconnect the BACKUP load and check whether the alarm is cleared. 2. If the load is disconnected and the alarm is generated, please contact the customer service. (After the alarm is cleared, the BACKUP switch needs to be manually turned on for normal use.)

9 Technical Specification

Model	SGN7.6K1HB-48	SGN11.4KHB-48
Input (PV)		
Max. PV Configuration		
Max. PV Input Power	12,000 W	15,000 W
Max. PV Voltage	600 V	
Start-up Voltage	90 V	
MPPT Operating Voltage Range	70 V to 540 V	
Max. Input Current per MPPT	30 A / 22 A / 22 A	
Max. Short Current per MPPT	40 A / 30 A / 30 A	
Nos. of MPPT	3	
Input /Output(BAT)		
Compatible Battery Type	Lithium-ion/Lead-acid	
Nominal Battery Voltage (Full load)	48 V	
Battery Voltage Range	40 V to 64 V	
Max. Charge/Discharge Current	210 A / 180 A	210 A / 210 A
Max. Charge/Discharge Power	10,000 W / 7,600 W	10000 W / 10000 W
Output (Grid)		
Nominal AC Output Power	7,600 W	10,000 W
Max. AC Output Apparent Power	7,600 VA	11,400 VA
Max. AC Output Power (PF=1)	7,600 W	11,400 W
Nominal AC Output Current	31.7 A	41.7 A
Max. AC Output Current	31.7 A	47.5 A
Nominal Grid Voltage	120 V / 240 V (Split phase) / 208 V (2/3 phase) V AC	
Nominal Grid Frequency	50/60 Hz	
Grid Frequency Range	45 Hz to 55 Hz / 55 Hz to 65 Hz (Adjustable)	
Power Factor	> 0.99 @rated power (Adjustable 0.8LD to 0.8LG)	
THDI	< 3% (Rated Power)	
Output (Back up)		
Nominal Output Power	7,600 W	10,000 W
Max. AC Output Power (PF=1)	7,600 W	11,400 W
Nominal Output Current	31.7 A	41.7 A
Peak Power (1s)	15,200 VA	20,000 VA
Nominal Output Voltage	120 V / 240 V (Split phase) / 208 V (2/3 phase) V AC	
Nominal Output Frequency	50 Hz / 60 Hz	
Transfer Time	< 10 ms (typical)	
THDV	< 3% @100% R Load	

Model	SGN7.6K1HB-48	SGN11.4KHB-48
Protection		
Protection Category	Class I	
DC Switch	Yes	
Anti-islanding Protection	Yes	
AC Overcurrent Protection	Yes	
DC/AC Overvoltage Protection	DC Type II, AC Type IV	
AC Short Circuit Protection	Yes	
DC Reverse Protection	Yes	
Surge Arrester	DC Type II , AC Type II	
Insulation Resistance Detection	Yes	
Leakage Current Protection	Yes	
AFCI	Yes	
RSD	Yes	
Generator	Yes	
General		
Max. Operation Altitude	2000 m	
Ingress Protection Degree	NEMA 3R	
Operating Temperature Range	-25 °C to + 60 °C (> 45 °C derating)	
Relative Humidity	0 to 100%	
Cooling Method	Fan Cooling	
Mounting	Wall Bracket	
Dimensions (W*H*D)	16.5 in × 31.5 in × 9.4 in (420 mm × 800 mm × 240 mm)	
Weight	40 kg (88 lb)	
PV Connection Way	Terminals	
HMI & COM		
Display	Wireless & APP + LED, LCD (optional)	
Communication interface	RS485/CAN (for BMS), DRM/RS485 (for meter), RS485, optional: Wi-Fi/LAN	
Certification		
Safety	UL 1741/CSA C22.2/UL 1699B	
EMC	FCC Part 15 ClassB	
Warranty	10 Years	

Remarks :

- The range of output voltage and frequency may vary depending on different grid codes.
- Specifications are subject to change without advanced notice.

Battery system home storage series

User Manual



Product Name:48V100Ah Lithium Battery

Product Model:SG48100P

Product Specifications:51.2V 100Ah

Catalogue

1. Document description	2
2. Definition of Terms	2
3. Battery system performance parameters	2
4. Outline and Structural Dimensions of Battery System	4
5. Definition of battery system interface	5
6. Functional block diagram.....	7
7. Battery Management System Specifications.....	8
7.1.Basic parameter settings.....	8
7.2.Interface	12
7.3.Communication description	14
8. Product function and performance description	15
8.1.Charging performance.....	15
8.2.Discharge curve at different magnification.....	15
9. Using & Maintenance Suggestions	16
9.1.LED indication description	16
9.2. Buzzer action description.....	17
9.3. Key Description	17
9.4.Sleep and wake up.....	18
9.5.DIP switch settings.....	19
9.6.The routine maintenance of the battery part can be carried out by referring to the table ...	21
9.7.Battery pack communication parallel wiring	22
9.8 .Battery pack power cable wiring	22
9.9.LCD Display Detailed Explanation	24
10. Packing List.....	25
See below for packing list.....	25
11. Storage, maintenance and transportation	25
11.1.Storage	25
11.2. Transportation	26
12. Maintain	26
13. Battery usage precautions.....	26
14. Product Liability.....	27

1.Document description

This specification covers the performance indexes, technical requirements and safety issue of the 48V100Ah.

2.Definition of Terms

BMS	Battery Management System
DOD	Depth Of Discharge
EOL	End Of Life
OCV	Open Circuit Voltage
SOC	State Of Charge
SOH	State Of Health
EMC	Electro Magnetic Compatibility
Nominal voltage	Appropriate voltage approximation to identify or identify a cell or an electrochemical system.
Capacity	(The amount of power a battery can provide when fully charged under specified conditions. Usually expressed in Ah.)
Energy	The energy that can be provided by a fully charged battery under specified conditions. Usually expressed in Wh or kWh.
Unit	“V” (Volt) (Voltage unit) “A” (Ampere) (Current unit) “Ah” (Ampere-Hour) (unit of charge) “Wh” (Watt-Hour) (electrical energy unit) “Ω” (Ohm) (resistance unit) “°C” (degree Celsius) (temperature unit) “mm” (millimetre) (length unit) “s” (second) (Time unit) “kg” (kilogram) (Weight unit) “Hz” (Hertz) (Frequency unit)

3.Battery system performance parameters

No.	Item	Technical parameter	Note
1	Battery Type	Lithium iron phosphate battery	/
2	Rated capacity	100Ah	@25°C±2, 0.2C, 100%DOD

3	Nominal voltage	51.2V	
4	Recommended charging voltage	54.5V	
5	Charging Limited Voltage	57.6V	
6	SOC working range	0~100%	Recommended range of use: 20%~95%
7	Standard discharge current	50A	
8	Maximum continuous discharge current	100A	
9	Standard charging current	50A	
10	Maximum continuous charge current	100A	
11	Maximum cut-off voltage for charging	57.6V	
12	Charge cut-off current	5A	0.05C magnification
13	Discharge cut-off voltage	43.2V	
14	PACK cycle life	≥ 7000	80%DOD 25°C±2°C, 0.5C charge/0.5C discharge
15	Thermal management method	Natural heat dissipation	
16	IP protection class	IP31 battery box	
17	Flammability rating	plastic parts UL94 V-0	
18	Total system mass	Around 43KG	
19	Battery system shell material	BLACK Q235A	Color can be customized
20	Shipping SOC	SOC45-55%	
21	Dimension (L*W*H mm)	☑442*460*133 (3U) ±1mm	
22	Design life	15 Year	
23	Parallel function	Supports up to 63 batteries in parallel	
24	Display function	English smart display	
25	Charging current limit function	Current limit 20A	Charging current limit can be set according to customer requirements
26	Communication mode	☑RS232	Communication mode can be set according to customer requirements
		☑RS485	
		☑CAN	
27	communication protocol	Support multiple protocols	Communication protocol can be set according to customer requirements
28	Storage ambient temperature	-10~+45°C	Recommended storage temperature: 0~+30°C
29	Working temperature	Battery charging: 0~ 45°C Battery discharging:-20~ +60°C	
30	Relative humidity of working environment	≤ 95	Best Use Relative Humidity: ≤85%

4. Outline and Structural Dimensions of Battery System

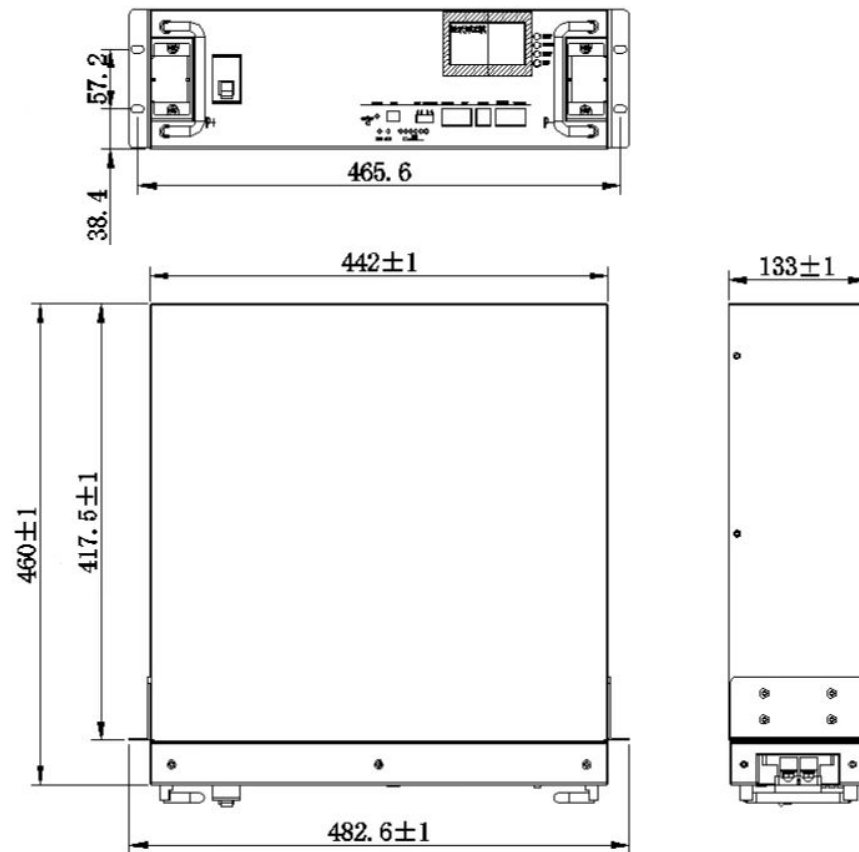

5. Definition of battery system interface

5.1. Panel Schematic

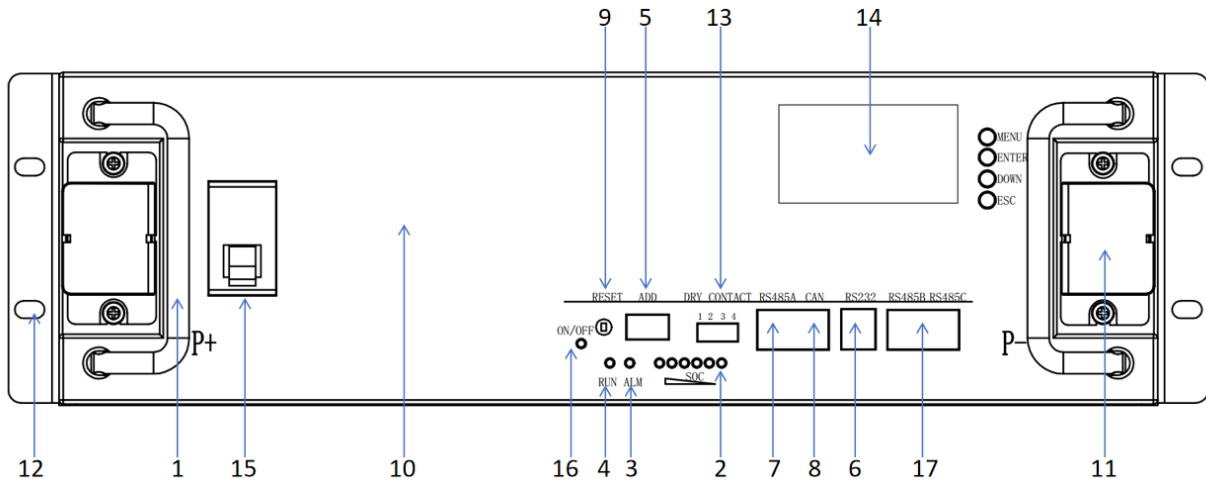

5.2. Module Panel Description

NO	Function definition	Function Description	Note
1	Handle	Carrying handle	
2	SOC	Capacity status light	Six green LED lights to show the current charge of the lithium battery pack
3	ALM	Alert	Red LED light, normally off under normal conditions, always on under fault conditions, and a voice prompt
4	RUN	Run	Green light, always on when the product is running
5	ADD	DIP switch	Use 6 bit binary DIP switch to set address allocation when products are used in parallel
6	RS232	RS232 communication	Uplink communication port, RS232 communication mode when uploading data, data content includes system parameters, system status and alarm information. The rate of 9600bps is generally used. Note: Wiring definitions are implemented in accordance with BMS product specifications
7	RS485	RS485 communication	RS485 communication method
8	CAN	CAN communic	CANcommunication method
9	RESET	Reset	When the product is in an abnormal state or in a hibernation state, the product can be restarted and woken up through the reset button to ensure the stable operation of the system
10	Main panel	Shell	Sheet metal thickness 1.5mm, galvanized frosted paint, color: black

11	Terminals	Input and output terminals	Battery positive and negative output terminals
12	Hanging ears	Mounting ears	The spacing is implemented according to the national standard
13	dry contact terminal	Load output port	<p>example: definition:</p> <p>Dry contact 1-PIN1 to PIN2: normally open, closed during fault protection</p> <p>Dry contacts 2-PIN3 to PIN4: normally open, SOC<5%, closed for low battery alarm.</p>
14	Display	Display screen	Battery information can be viewed on the display
15	Air breaker	Breaker	For controlling battery output
16	ON/OFF	ON/OFF	Battery switch status indicator
17	Parallel dual RS485	RS485B RS485C	For battery parallel RS485 communication

6. Functional block diagram

The functional block diagram is shown in the figure below

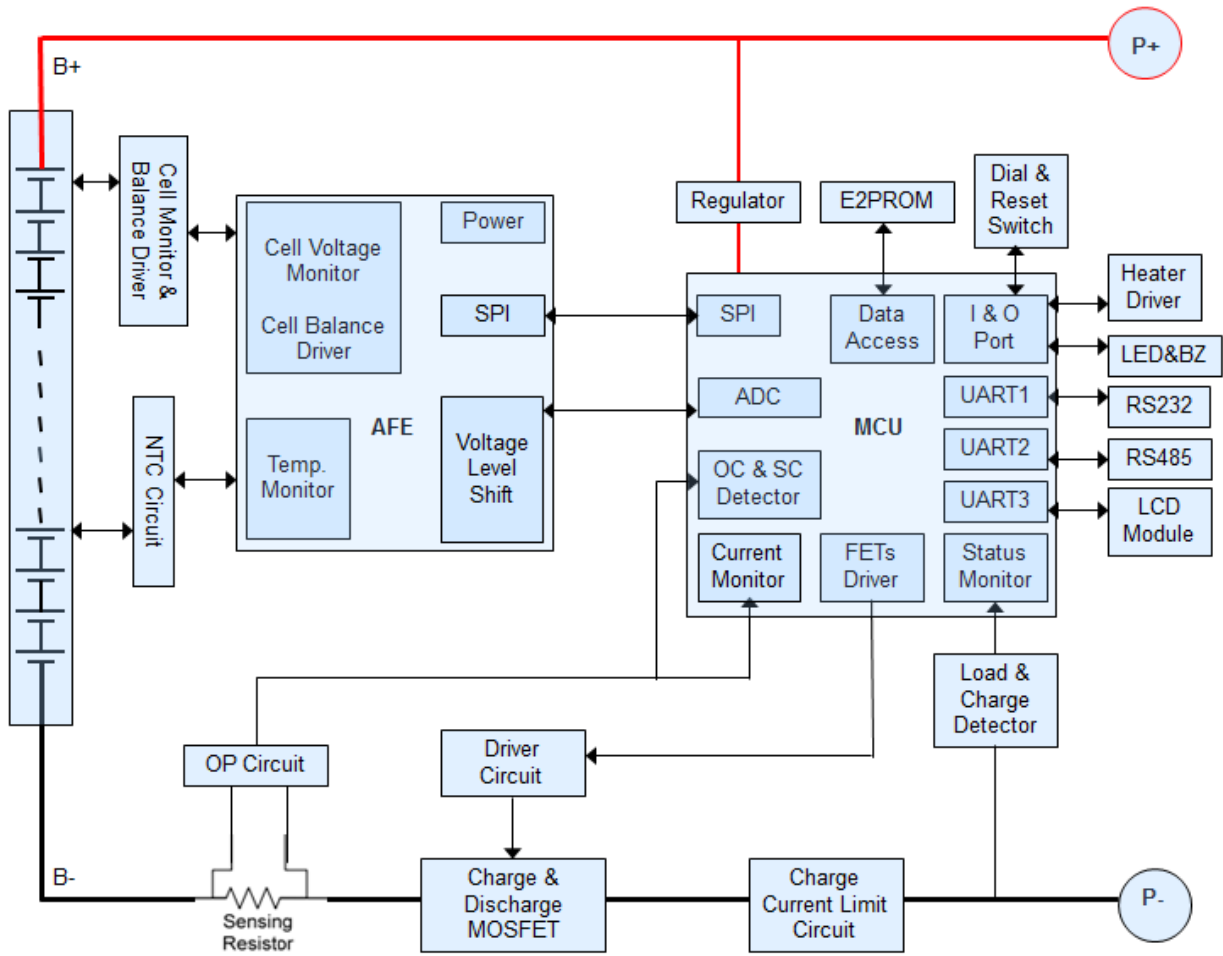

7. Battery Management System Specifications

7.1. Basic parameter settings

NO.	Indicator item		Factory default parameters	Is it possible to set	Note
1	Cell overcharge protection	Cell overcharge alarm voltage	3600mV	Can be set	
		Cell overcharge protection voltage	3700mV	Can be set	
		Cell overcharge protection delay	4.0S	Can be set	
	Single Over voltage Protection Released	overcharge protection release voltage Cell	3380mV	Can be set	
		Capacity release	SOC < 96%	Can be set	
		Discharge release	discharge current > 2A		
2	Cell over discharge protection	Cell over-discharge alarm voltage	2700mV	Can be set	After 30 seconds of over-discharge protection, if it still cannot recover, it will enter low power consumption mode
		Cell over-discharge protection voltage	2500mV	Can be set	
		Monomer over-discharge protection delay	1.0S	Can be set	
	Cell over-discharge protection released	Cell over-discharge protection release voltage	2800mV	Can be set	
		(Release when charging)	Plug into the charger to activate		
3	Overall overcharge protection	Overall overcharge warning voltage	57.6V	Can be set	
		Overall overcharge protection voltage	58.4V	Can be set	
		Overall overcharge protection delay	1.0S	Can be set	
	Overall overvoltage protection released	Overall overcharge protection release voltage	54.1V	Can be set	
		Capacity release	SOC < 96%	Can be set	
		Discharge release	discharge current > 2A		
4		Overall over-discharge warning voltage	43.2V	Can be set	After 30 seconds of over-discharge

	Overall over discharge protection	Overall over-discharge protection voltage	40V	Can be set	protection, if it still cannot recover, it will enter low power consumption mode
		Overall over-discharge protection delay	1.0S	Can be set	
	Overall over-discharge protection released	Overall over-discharge protection release voltage	44.8V	Can be set	
		Release when charging	Plug into the charger to activate		
5	Charging current limit function	Charging current limit	20A		
6	Charge over current protection	Charge over current alarm current	105A	Can be set	Appearing 10 times in a row will lock the status and will no longer automatically release
		Charge over current protection current	110A	Can be set	
		Charge over current protection delay	1.0S	Can be set	
	Charging over current protection released	Automatic release	Automatically cancel after 1min		
Discharge release		Discharge current > 1A			
7	Discharge over current 1 protection	Discharge over current 1 alarm current)	105A	Can be set	Appearing 10 times in a row will lock the status and will no longer automatically release
		Discharge over current 1 protection current)	110A	Can be set	
		Discharge over current 1 protection delay	1.0S	Can be set	
	Discharge over current 1 protection released	Automatic release	Automatically cancel after 1min		
		Charge release	Charge current > 1A		
8		Discharge over current 2 protection current	≥150A	Can be set	Appearing 10 times in a row will lock

	Discharge over current 2	Discharge over current 2 protection delay	500mS	Can be set	the status and will no longer automatically release
	Discharge over current 2 protection released	Automatic release	Automatically cancel after 1min		
		charge release	Charge current > 1A		
9	Short circuit protection	Short circuit protection function		(Have)	
		Short circuit protection released	When there is charging, the short circuit protection is released		
			After the load is removed, it will automatically disarm		
10	MOS high temperature protection	MOS over temperature alarm temperature)		90°C	Can be set
		MOS over temperature protection temperature)		115°C	Can be set
		MOS protection release temperature)		85°C	Can be set
11	Cell temperature protection	Charging low temperature warning temperature)		0°C	Can be set
		Charging low temperature protection temperature)		-5°C	Can be set
		Charging low temperature protection release temperature		0°C	Can be set
		Charging high temperature alarm temperature	55°C		Can be set
		Charging high temperature protection temperature)	60°C		Can be set
		Charging high temperature protection release temperature	50°C		Can be set
		Discharge low temperature alarm temperature	-15°C		Can be set
Discharge low temperature protection temperature	-20°C		Can be set		
(Discharge low temperature protection release temperature	-15°C		Can be set		

		Discharge high temperature alarm temperature	60°C	Can be set	
		Discharge high temperature protection temperature	65°C	Can be set	
		Discharge high temperature protection release temperature	55°C	Can be set	
12	Ambient temperature alarm	Ambient low temperature alarm temperature	-15°C	Can be set	
		Ambient low temperature protection temperature	-20°C	Can be set	
		Ambient cryogenic protection release temperature	-15°C	Can be set	
		Ambient high temperature alarm temperature	65°C	Can be set	
		Ambient high temperature protection temperature	75°C	Can be set	
		Ambient high temperature protection release temperature	65°C	Can be set	
13	Current consumption	Self-consumption current during operation	≤55mA (with display)		
			≤45mA(without display)		
		Low power mode current	≤200μA		
14	Equalization function	Equalization turn-on voltage	3500mV	Can be set	
		Open differential pressure	30mV	Can be set	
15	Capacity default settings	Low battery warning	SOC<5%	Can be set	(No alarm when charging)
		Full capacity setting	100AH	Can be set	
16	Sleep function	Sleep voltage	3150mV	Can be set	
		Delay	5min	Can be set	
		Over pressure recovery	500mV		
17	Cell failure protection	Monomer differential pressure	Voltage difference>1V		Charge and discharge are not allowed
18	Full charge judgment	Full charge voltage	56V	Can be set	After simultaneously satisfying, Stop
		Cut off current	5A	Can be set	

					charging and update SOC to 100%
--	--	--	--	--	------------------------------------

7.2.Interface

7.2.1.Interface diagram

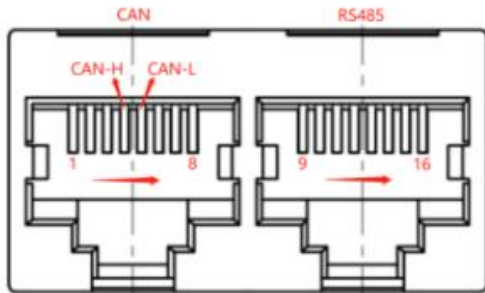

CAN and RS485 interface



1 2 3 4

dry contact

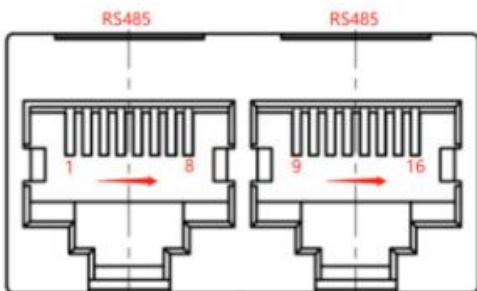

Parallel communication port

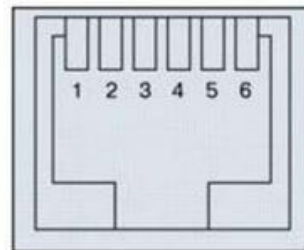

RS232 communication interface

7.2.2. Interface Definition

RS232--Using 6P6C vertical RJ11 socket	
RJ11	Definition description
2	NC
3	TX
4	RX
5	GND

RS485 and CAN interface

RS485--Using 8P8C vertical RJ45 socket		CAN--Using 8P8C vertical RJ45 socket	
RJ45 Pin	Definition description	RJ45 Pin	Definition description
9、16	RS485-B1	1、3、6、 7、8	NC
10、15	RS485-A1	4	CAN-H
11、14	GND	5	CAN-L
12、13	NC	2	GND

Parallel communication port

RS485--Using 8P8C vertical RJ45 socket		RS485--Using 8P8C vertical RJ45 socket	
RJ45Pin	Definition description	RJ45 Pin	Definition description
1、8	RS485-B	9、16	RS485-B
2、7	RS485-A	10、15	RS485-A
3、6	GND	11、14	GND
4、5	NC	12、13	NC

7.3.Communication description

7.3.1. RS232 communication

The BMS can communicate with the host computer through the RS232 interface, so as to monitor various information of the battery on the host computer side, including battery voltage, current, temperature, status, SOC, SOH and battery production information, etc. The default baud rate is 9600bps.

7.3.2.RS485 communication

With dual RS485 interface, you can view the information of PACK, the default baud rate is 9600bps. To communicate with the monitoring device through RS485, the monitoring device is used as the host to poll data according to the address, and the address setting range is 2~63

7.3.3. CAN communication

CAN communication, baud rate 500K.

8.Product function and performance description

8.1.Charging performance

- ◆ Standard charging current (25°C)
- ◆ Standard charging voltage: 57.6V
- ◆ Standard charging mode and charging curve:

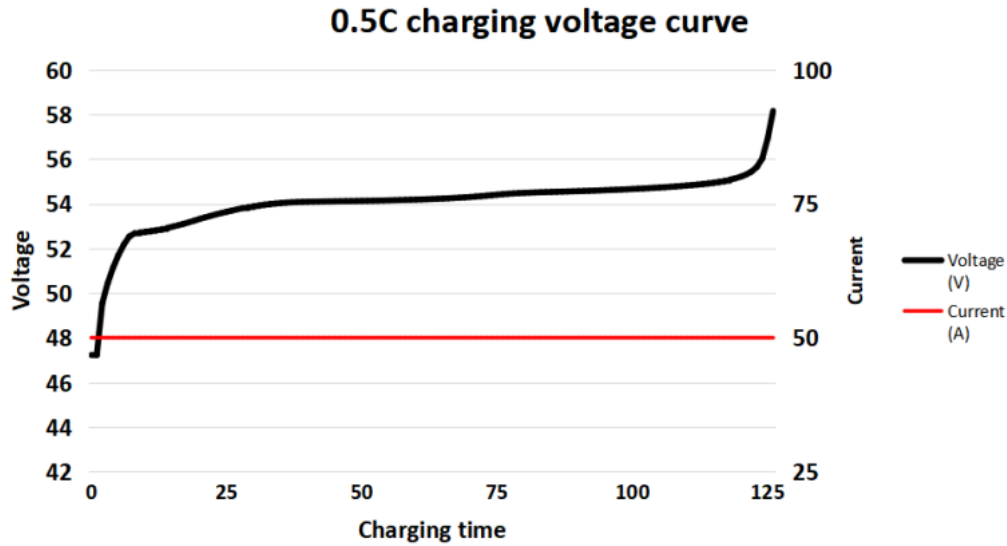

8.2.Discharge curve at different magnification

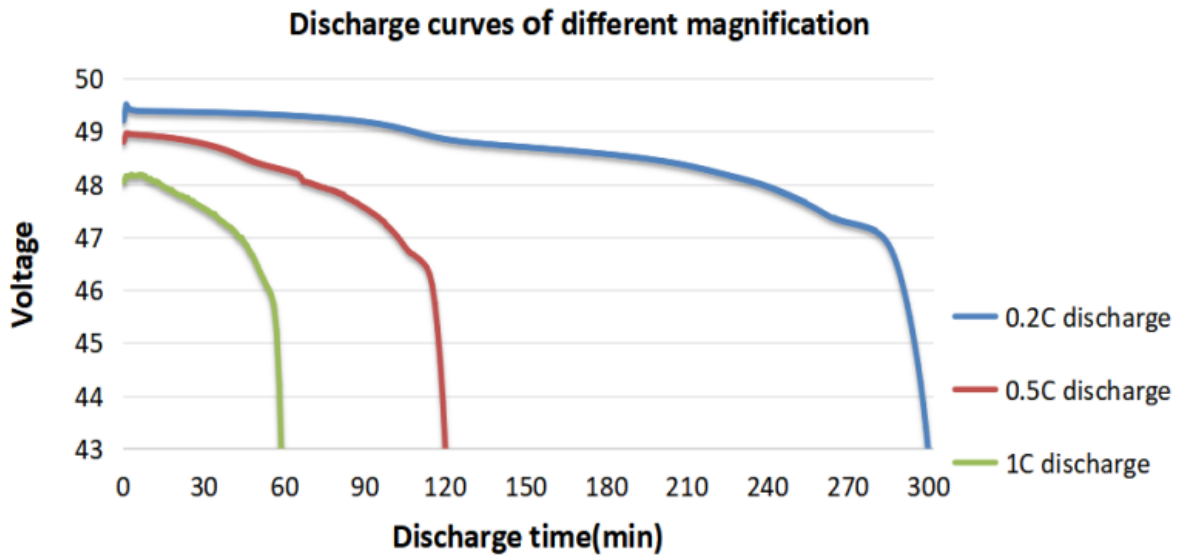

9.Using & Maintenance Suggestions

9.1.LED indication description

Table 1 LED working status indication

Condition		Charging						Discharging					
Capacity indicator		L6●	L5●	L4●	L3●	L2●	L1●	L6●	L5●	L4●	L3●	L2●	L1●
Electricity (%)	0 ~ 17%	black	black	black	black	black	flash2	black	black	black	black	black	Always bright
	17 ~ 33%	black	black	black	black	flash 2	Always bright	black	black	black	black	Always bright	Always bright
	33 ~ 50%	black	black	black	flash 2	Always bright	Always bright	black	black	black	Always bright	Always bright	Always bright
	50 ~ 66%	black	black	flash 2	Always bright	Always bright	Always bright	black	black	Always bright	Always bright	Always bright	Always bright
	66-83%	black	flash 2	Always bright	Always bright	Always bright	Always bright	black	Always bright	Always bright	Always bright	Always bright	Always bright
	83-100%	flash 2	Always bright	Always bright	Always bright	Always bright	Always bright	Always bright	Always bright	Always bright	Always bright	Always bright	Always bright
Running lights●		Always bright						flash3					

Table 2 Description of capacity indication

Condition	Normal/Alarm/Protect	RUN ●	ALM ●	LED						Illustrate
				Battery indicator LED						
				●	●	●	●	●	●	
Shutdown	Hibernate	black	black	black	black	black	black	black	black	Annihilate
Standby	Normal	flash1	black	According to the battery indicator						Standby mode
	Alarm	flash1)	flash3							Module low voltage
Charging	Normal	Always bright)	black	According to the battery indicator (battery indication maximum LED flashes 2)						(The highest power LED flashes (flashing 2), the overcharge alarm ALM does not flash)
	Alarm	Always bright	3 flash3							
	Overcharge protection	Always bright	black	Always bright	Always bright	Always bright	Always bright	Always bright	Always bright	(If there is no utility power, the indicator light is in standby state)
	Temperature, overcurrent, fail safe	black	Always bright	black	black	black	black	black	black	black
Discharging	Normal	flash3	black	(According to the battery indicator)						
	Alarm	flash3)	flash3							
	Undervoltage protection	black	black	black	black	black	black	black	black	black

	Temperature, overcurrent, short circuit, reverse connection, fail safe	black	Always bright	black	black	black	black	black	black	Stop discharge
Invalid		black	Always bright	black	black	black	black	black	black	Stop charging and discharging

Table 3 LED flashing description

Flashing method	Bright	Black
flash 1	0.25S	3.75S
flash 2	0.5S	0.5S
flash 3	0.5S	1.5S

Note:

The LED indicator alarm can be enabled or disabled through the host computer, and the factory default is enabled.

9.2. Buzzer action description

- 1) In case of failure, it will beep for 0.25S every 1S;
- 2) During protection, it will beep for 0.25S every 2S (except for overvoltage protection);
- 3) When alarming, it will beep every 3S for 0.25S (except overvoltage alarm);
- 4) The buzzer function can be enabled or disabled by the host computer, and the factory default is disabled.

9.3. Key Description

- 1) When the BMS is in the dormant state, press the button (3~6S) and release it, the protection board will be activated, and the LED indicators will light up in sequence from "RUN" for 0.5 seconds.
- 2) When the BMS is activated, press the button (3~6S) and release it, the protection board is put to sleep, and the LED indicators light up sequentially for 0.5 seconds from the lowest battery light.
- 3) When the BMS is activated, press the button (6~10S) and release it, the protection board will be reset, and all the LED lights will light up at the same time for 1.5 seconds.

After the BMS is reset, it still retains the parameters and functions set by the host computer. If it is necessary to restore the initial parameters, it can be achieved through the "restore default value" of the host computer, but the relevant operation records and stored data remain unchanged (such as power, cycle times, etc.), protection records, etc.).

9.4.Sleep and wake up

9.4.1. Hibernate

When any of the following conditions are met, the system enters a low-power mode:

- ◆ The single or overall over-discharge protection has not been released within 30 seconds.
- ◆ Release the button after pressing the button for 3 seconds.
- ◆ The minimum cell voltage is lower than the sleep voltage, and the duration reaches the sleep delay time (at the same time, no communication, no protection, no balance, and no current are satisfied).
- ◆ The standby time is more than 24 hours (no communication, no charging and discharging, no mains power).
- ◆ Forced shutdown through the host computer software.

Before entering the sleep mode, make sure that the input terminal is not connected to an external voltage, otherwise it will not be able to enter the low power consumption mode.

9.4.2. wake

When the system is in low-power mode and meets any of the following conditions, the system will exit the low-power mode and enter the normal operation mode:

- ◆ Connect the charger, the output voltage of the charger must be greater than 48V.
- ◆ Press the button for 3S and release the button.
- ◆ Connect to the communication line and open the software of the upper computer (it enters the sleep state due to over-discharge protection, this method cannot wake up the protection board).

Remarks:

- ◆ After the single or overall over-discharge protection, it enters the low-power mode, wakes up regularly every 4 hours, and turns on the charge and discharge MOS. If it can be charged, it will exit the dormant state and enter normal charging; if it cannot be charged after 10 consecutive automatic wake-ups, it will no longer automatically wake up.
- ◆ When the system is defined as the end of charging, the recovery voltage is not reached after 2 days of standby (standby time setting value), and the charging is forced to resume until the end of charging again.

9.5.DIP switch settings

When the battery packs are used in parallel, different PACK can be distinguished by their hardware addresses, and the hardware address of each PACK in the entire battery stack is unique. The hardware addresses can be set in sequence through the DIP switches on the board. Refer to the following for the definition of the switches. surface.

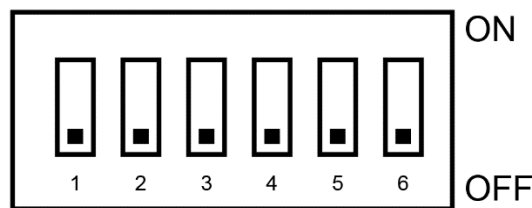

ADD	Dip switch position					
	#1	#2	#3	#4	#5	#6
1	ON	OFF	OFF	OFF	OFF	OFF
2	OFF	ON	OFF	OFF	OFF	OFF
3	ON	ON	OFF	OFF	OFF	OFF
4	OFF	OFF	ON	OFF	OFF	OFF
5	ON	OFF	ON	OFF	OFF	OFF
6	OFF	ON	ON	OFF	OFF	OFF
7	ON	ON	ON	OFF	OFF	OFF
8	OFF	OFF	OFF	ON	OFF	OFF
9	ON	OFF	OFF	ON	OFF	OFF
10	OFF	ON	OFF	ON	OFF	OFF
11	ON	ON	OFF	ON	OFF	OFF
12	OFF	OFF	ON	ON	OFF	OFF
13	ON	OFF	ON	ON	OFF	OFF
14	OFF	ON	ON	ON	OFF	OFF
15	ON	ON	ON	ON	OFF	OFF
16	OFF	OFF	OFF	OFF	ON	OFF

17	ON	OFF	OFF	OFF	ON	OFF
18	OFF	ON	OFF	OFF	ON	OFF
19	ON	ON	OFF	OFF	ON	OFF
20	OFF	OFF	ON	OFF	ON	OFF
21	ON	OFF	ON	OFF	ON	OFF
22	OFF	ON	ON	OFF	ON	OFF
23	ON	ON	ON	OFF	ON	OFF
24	OFF	OFF	OFF	ON	ON	OFF
25	ON	OFF	OFF	ON	ON	OFF
26	OFF	ON	OFF	ON	ON	OFF
27	ON	ON	OFF	ON	ON	OFF
28	OFF	OFF	ON	ON	ON	OFF
29	ON	OFF	ON	ON	ON	OFF
30	OFF	ON	ON	ON	ON	OFF
31	ON	ON	ON	ON	ON	OFF
32	OFF	OFF	OFF	OFF	OFF	ON
33	ON	OFF	OFF	OFF	OFF	ON
34	OFF	ON	OFF	OFF	OFF	ON
35	ON	ON	OFF	OFF	OFF	ON
36	OFF	OFF	ON	OFF	OFF	ON
37	ON	OFF	ON	OFF	OFF	ON
38	OFF	ON	ON	OFF	OFF	ON
39	ON	ON	ON	OFF	OFF	ON
40	OFF	OFF	OFF	ON	OFF	ON
41	ON	OFF	OFF	ON	OFF	ON
42	OFF	ON	OFF	ON	OFF	ON
43	ON	ON	OFF	ON	OFF	ON
44	OFF	OFF	ON	ON	OFF	ON
45	ON	OFF	ON	ON	OFF	ON
46	OFF	ON	ON	ON	OFF	ON
47	ON	ON	ON	ON	OFF	ON
48	OFF	OFF	OFF	OFF	ON	ON
49	ON	OFF	OFF	OFF	ON	ON
50	OFF	ON	OFF	OFF	ON	ON
51	ON	ON	OFF	OFF	ON	ON
52	OFF	OFF	ON	OFF	ON	ON
53	ON	OFF	ON	OFF	ON	ON
54	OFF	ON	ON	OFF	ON	ON
55	ON	ON	ON	OFF	ON	ON
56	OFF	OFF	OFF	ON	ON	ON
57	ON	OFF	OFF	ON	ON	ON
58	OFF	ON	OFF	ON	ON	ON
59	ON	ON	OFF	ON	ON	ON
60	OFF	OFF	ON	ON	ON	ON
61	ON	OFF	ON	ON	ON	ON
62	OFF	ON	ON	ON	ON	ON
63	ON	ON	ON	ON	ON	ON

9.6. The routine maintenance of the battery part can be carried out by referring to the table

Period	Item	Treatment measures
Per month	(Operating environment)	Keep away from heat sources and avoid direct sunlight
	Visual inspection	If the appearance is damaged, leaked or deformed, the faulty battery pack should be disconnected, photographed and replaced.
Each quarter	Clean appearance	Clean the exterior with a cotton cloth. Due to the high voltage of the battery pack, care should be taken when cleaning.
	Connection Status	<ul style="list-style-type: none"> ● Check the bolts at each terminal and retighten them if they are loose. ● If the temperature of the connection line exceeds 40°C (feeling hot), check the cause
Every half year	Voltage detection	<ul style="list-style-type: none"> ● At the end of charging, measure and record the busbar voltage and the positive and negative terminal voltages of the battery pack. The voltages of the two are consistent. Otherwise, check whether the cable at the corresponding connection is faulty. ● In the first year, real-time data collection at the end of discharge was performed at least every six months. ● Beginning in the second year, on-site capacity determination will be conducted every three months. If a certain battery cell is frequently overcharged and over-discharged in the historical alarm information viewed through the RS232 interface, it means that the battery cell has touched the charging protection point and the discharging protection point for a long time. This situation may lead to insufficient backup time, it is recommended to replace it in time

The final state of charge and discharge can be judged by the capacity light, refer to the definition of LED light capacity status light.

9.7. Battery pack communication parallel wiring

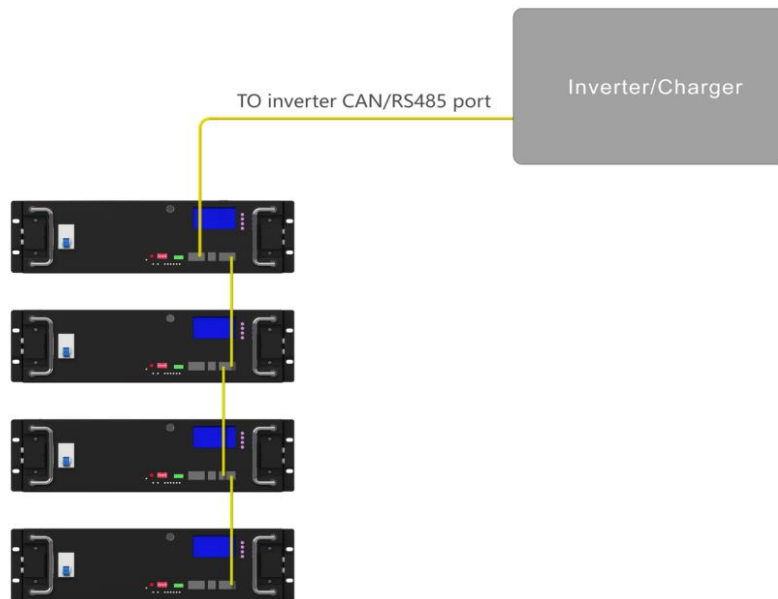

9.8 .Battery pack power cable wiring

Please note:

1. Batteries cannot be used in series.
2. When connecting in parallel, it is necessary to pay attention to the SOC, the SOC must be consistent before connecting in parallel.
3. Please turn off the inverter and turn off the battery before connecting the battery system in parallel, and then turn on the battery and inverter again after capacity expansion.
4. The connecting cables between battery and battery should be the same length, and the connecting cables between battery and inverters should be the same length.
5. The wire gauge of the connecting cable between batteries and the cable between battery and inverter is related to the volume of charging current and discharging current and the wiring connection method, etc., so it can not be standardized, If there are any questions, please consult the supplier.
6. It is recommended to have the system installed by a qualified professional.

Suggested option 1 (example:4 batteries) :

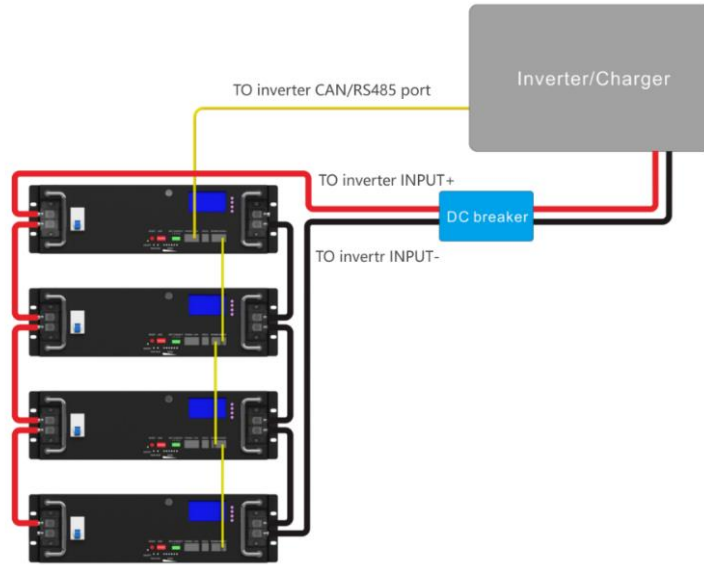

Suggested option 2 (example:4 batteries) :

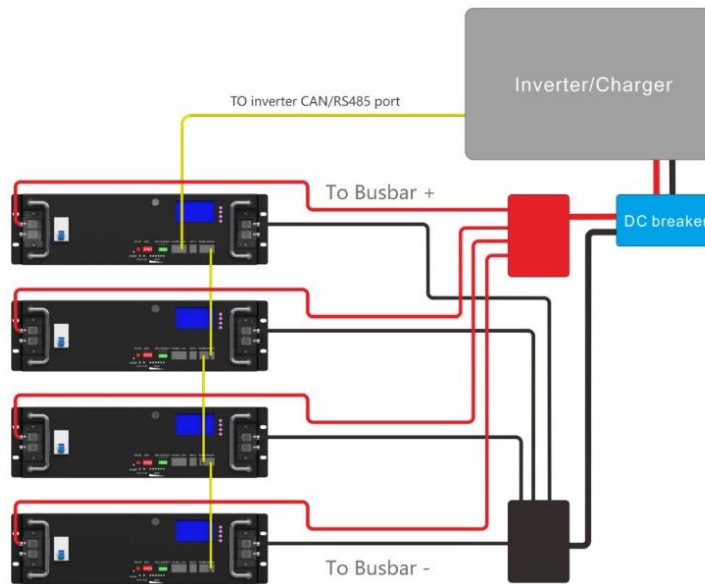

Wiring diggram not allowed:

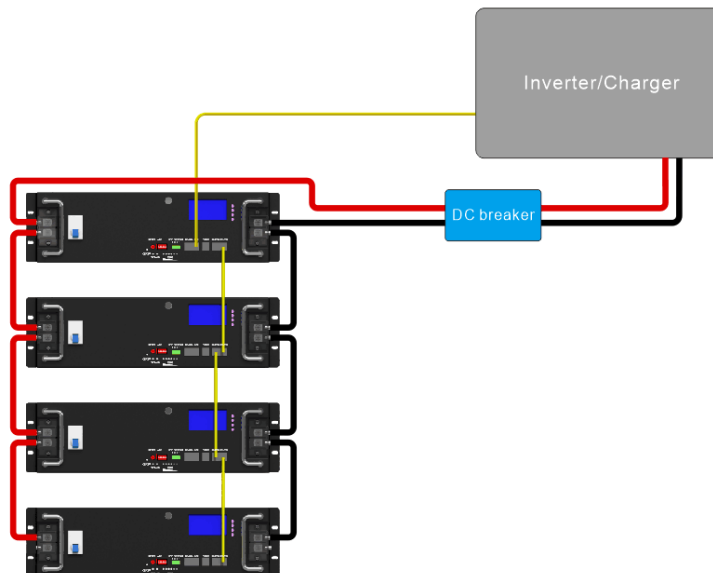

9.9.LCD Display Detailed Explanation

Menu						
First level column		Secondary Column		Level three column		
Name	Meaning	Name	Meaning	Name	Meaning	
Analog Info	Analog Info	PackV	Pack Voltage			
		Im	Current			
		Temperature	Temperature	T1	Temperature T1	
				T2	Temperature T2	
				T3	Temperature T3	
				T4	Temperature T4	
				PCB_T	MOS Temperature	
				ENV_T	Environment Temperature	
		Cell Voltage	Cell Voltage	Cell01:	Cell Voltage 01:	
				Cell02:	Cell Voltage 02:	
				
				Cell15:	Cell Voltage 15:	
				Cell16:	Cell Voltage 16:	
		CellCapacity	CellCapacity	SOC	State Of Charge	
				FCC	Full Charge Capacity	
				Rm	Remain Capacity	
CC	Cycle Count					
BMS Status	BMS Status	Status	BMS Status			
		Record	Fault Record	SCP	Short Circuit Protection	
				O/UTP	Over / Under Temperature Protection	
				OCP	Over Current Protection	
				UVP	Under Voltage Protection	
				OVP	Over Voltage Protection	
		BMS Status	BMS Status	OT	Over Temperature Warning	
				OTP	Over Temperature Protection	
				OV	Over Voltage Warning	
				OVP	Over Voltage Protection	
				UV	Under Voltage Warning	
				UVP	Under Voltage Protection	
				OC	Over Current Warning	
				OCP	Over Current Protection	
SCP	Short Circuit Protection					
Failure	Failure					
Para Setting	Para Setting	Non-Production manufacturer can not use				
Sys Setting	Sys Setting	Baud rate	Baud rate			

10.Packing List

See below for packing list

NO.	Material name	Specification/Module	Number
1	48100Ah lithium iron phosphate battery	48100	1 set/box
2	Positive and negative output lines	25mm ² flame retardant cable, length 0.5m, crimp 25-8 copper noses at both ends, one red and one black.	1 set/1 module
3	RS485 cascade communication line	0.5 meters long, with RJ45 crystal heads at both ends.	1root/1 modules
4	RS232 USB	1.2 meters long, one end is the corresponding crystal head, and the other end is the USB interface.	optional
5	Product manual	/	1
6	Certificate	/	1
7	Hanging ear screw	M6*16(stud 16mm)	4
8	Dry contact terminal	Matching according to the number of dry nodes of the BMS	1

11.Storage, maintenance and transportation

11.1.Storage

- ◆ The battery pack is usually stored at a state of charge of 20% to 40% in a clean, dry, ventilated and rain-proof room with an ambient temperature of -5°C to 35°C and a relative humidity of not more than 75%, and should be placed flat. Pad height, not less than 100MM from the ground;
- ◆ Batteries cannot be stored with active chemicals or dusting items;
- ◆ The battery cannot be subjected to any mechanical shock or heavy pressure;
- ◆ The battery should avoid direct sunlight, keep away from the fire source, and the distance from the heat source should not be less than 2M;
- ◆ From the date of manufacture, every 3 months of storage should be charged with a current of 0.2~0.5C for 30~60min, and the temperature range is 25°C±5°C.5) .

11.2. Transportation

The battery pack should be packaged and shipped. During transportation, avoid severe vibration, shock or extrusion, and avoid sun and rain. Batteries can be transported by vehicles such as cars, trains, ships, and planes.

12. Maintain

The battery pack should remain at 40% - 60% of state of charge;

When the battery is not in use for a long time, it is recommended to charge it with 0.2c current every three months or so.

During the maintenance process, do not install or remove the battery in the battery pack by yourself, otherwise the battery performance will be reduced;

Any battery in the battery pack shall not be disassembled or replaced without authorization, and dissection of the battery is strictly prohibited.

13. Battery usage precautions

Please read the instruction manual and precautions carefully before use. When used correctly according to the product characteristics, the battery will be a safe, reliable and convenient storage battery.

Warn! Improper use of lithium-ion batteries can result in personal injury or fire!

1. When charging the battery, pay attention to ensure that the polarity is correct, and do not reverse the charging of the battery;
2. Do not expose the battery to adverse environments, such as extreme temperatures, deep cycling, frequent overcharge/overdischarge;
3. If you find that the battery is abnormal, please stop using it immediately and report it to a

- professional for treatment;
4. Ensure that batteries and battery management systems are kept away from dangerous goods or dangerous materials;
 5. It is forbidden to short-circuit the battery;
 6. It is forbidden to burn or destroy the battery, which may cause the release or burning of harmful gases;
 7. Do not disassemble, squeeze, pierce or burn.
 8. Rain is prohibited;
 9. It is forbidden to be directly exposed to sunlight;
 10. Prohibit exposure to temperatures above 60°C;
 11. It is forbidden to discard the battery in the garbage;
 12. It is forbidden to use other types of batteries in series or in parallel with lithium-ion batteries;
 13. It is forbidden to use new and old batteries (groups) in series or in parallel.

14. Product Liability

Consumers must strictly abide by the requirements of this product specification to use this product. Misuse may lead to serious accidents. The company is not responsible for any accidents caused by the operation and use that are not strictly in accordance with this product specification. The company reserves the right to change the contents of this specification without prior notice; the final interpretation right of this information belongs to the company.

N-Type High efficiency

Bifacial Dual Glass Module

SGN-450-BDG5



Bifacial technology allows for the harvesting of up to an additional 30% energy from the rear side of the module.



30 years lifespan brings 10-30% additional power generation comparing with conventional P-type module.



N-type solar cell has no LID naturally which can increase power generation.



Excellent low irradiance performance.



Enhanced light trapping and optimized current collection contribute to the improvement of both module power output and reliability.



Industry leading lowest thermal coefficient of power.



Design optimized for lower operating current, resulting in minimized hot spot loss and improved temperature coefficient.



Certified to withstand: wind load (2400 Pa) and snow load (5400 Pa).



100% triple EL test enables remarkable reduction of module hidden crack rate.

LINEAR PERFORMANCE WARRANTY

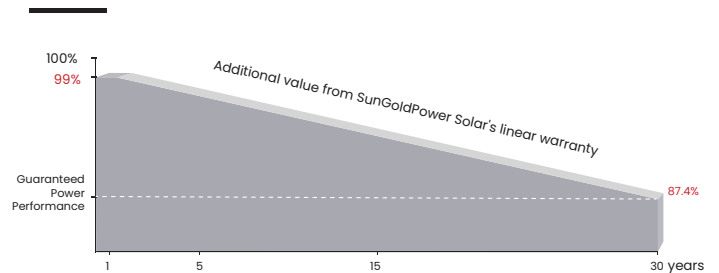

up to **12** years
Product quality & process guarantee

30 years
Linear power guarantee

0.40 %
Annual degradation Over 30 years

COMPREHENSIVE CERTIFICATES



UL61730 Certified by ETL,CEC Listed

ISO 9001: Quality Management System

ISO 14001: Environmental Management System Standard

ISO 45001: International Occupational Health and Safety Assessment System Standard

* Different markets have different certification requirements. Also, the products are under rapid innovation. Please confirm the certification status with regional sales representatives.

ELECTRICAL CHARACTERISTICS

Model of modules	SGN-450-BDG5	
	STC	NMOT
Peak power - P_{mp} (W)	450	338
Open circuit voltage - V_{oc} (V)	35.03	33.28
Short circuit current - I_{sc} (A)	16.05	12.96
MPP voltage - V_{mp} (V)	30.08	27.96
MPP current - I_{mp} (A)	14.97	12.09
Module efficiency - η_m (%)	22.5	

STC (Standard Testing Conditions): Irradiance 1000W/m², Cell Temperature 25 °C, Spectra at AM1.5

NMOT (Nominal Module Operating Temperature): Irradiance 800W/m², Ambient Temperature 20°C, Spectra at AM1.5, Wind at 1m/s

ELECTRICAL CHARACTERISTICS WITH DIFFERENT POWER BIN (REFERENCE TO 13.5% IRRADIANCE RATIO)

Peak power - P_{mp} (W)	499
Open circuit voltage - V_{oc} (V)	35.03
Short circuit current - I_{sc} (A)	17.78
MPP voltage - V_{mp} (V)	30.08
MPP current - I_{mp} (A)	16.59
Irradiance ratio (rear/front)	13.5 %

STRUCTURAL CHARACTERISTICS

Module dimension (L*W*H)	69.37 x 44.65 x 1.38 inch (1762 x 1134 x 35 mm)
Weight	53.35 lbs (24.2 kg)
Number of cells	96 cells
Cell	N-type monocrystalline (7.17 X 8.27 inch (182X210 mm))
Front Glass	2.0mm, Anti-Reflection Coating
Back Glass	2.0mm, Heat Strengthened Glass
Frame	Black anodized aluminum alloy
Junction box	IP68 rated (3 diodes)
Output wire	4mm ² (IEC),12 AWG (UL)
Wire length (Including Connector)	+400/-200mm (+15.75/-7.87in.)or customized
Connector	MC4 Compatible
Pieces per Pallet	31 pcs/Pallet
Pieces per Container (Normal/Weight-limited area)	806/744 pcs/40'HQ

OPERATING PARAMETERS

Power tolerance (W)	(0,+5)
Maximum system voltage (V)	1500
Maximum rated fuse current (A)	30
Current operating temperature (°C)	-40~+185 °F (-40~+85 °C)
Bifaciality	80±10 %
Fire performance	Type 29

MECHANICAL LOADING

Front side maximum static loading (Pa)	5400
Rear side maximum static loading (Pa)	2400
Hailstone test (mm)	35

TEMPERATURE RATINGS

Temperature coefficient (P_{max})	-0.29 %/K
Temperature coefficient (V_{oc})	-0.28 %/K
Temperature coefficient (I_{sc})	+0.04 %/K
Nominal Module Operating Temperature	109.4±35.6 °F (43±2 °C)

MODULE DIMENSIONS (MM)

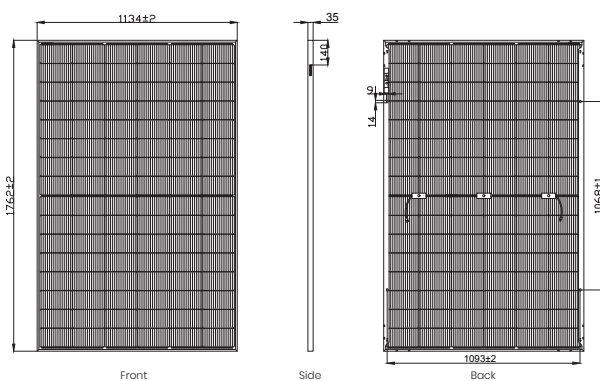

Characteristic curves (450W)

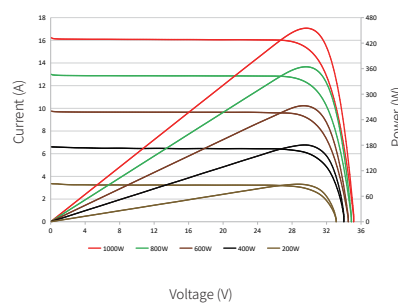

Temperature Dependence of I_{sc} , V_{oc} , P_{max}

